

ELETTROTEK **KABEL**® **GROUP**

AUTOMATION AND FLEXIDRUM®



ELETTROTEK **KABEL**® **GROUP**

Elettrotek Kabel was founded in Italy at the end of 2001.

We specialize in offering electrical wire & cable for SPECIAL applications in several different sectors, in particular Industrial Automation.

Through the years, the company expanded and created a network of branches and subsidiaries that exports to over 45 different countries, all around the globe.

Elettrotek Kabel has warehouses in Italy, Switzerland, Germany, USA, Dubai, Abu Dhabi and Canada.

We are one of the first companies in the world to produce and distribute SPECIAL cables for use in the following industries: Industrial Automation, Iron & Steel, Mining, Port Sector, Marine, and Oil & gas.

This rapid expansion has been made possible thanks to the competency of Elettrotek Kabel Group's management team and their constant focus on using only the highest quality products.

Elettrotek Kabel continues to invest in improving the quality of our product line and the customer care experience.

These elements have helped the company grow swiftly in a short period and have contributed in establishing Elettrotek Kabel's worldwide network of partnerships.



Roberto Gallingani
General manager

WORLDWIDE PRESENCE

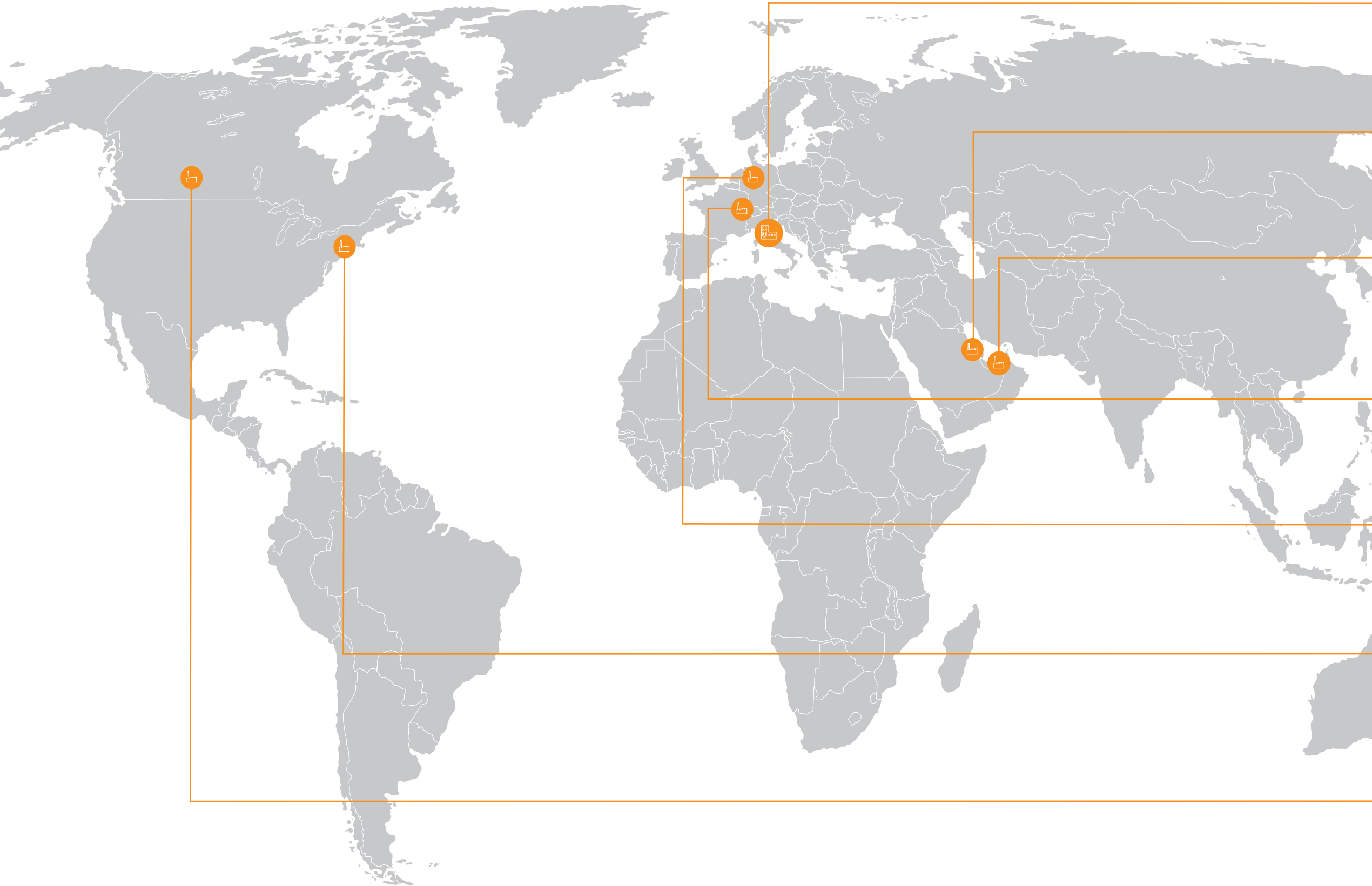

ELETTROTEK KABEL[®]

ELETTROTEK KABEL S.p.A.

Headquarter
Via Imerio Tondelli, 10
42011 Bagnolo in Piano - RE - Italy
Phone: +39 0522 956 001
Fax: +39 0522 953 655
Email: info@eletrotekkabel.com

ELETTROTEK KABEL[®] **ABU DHABI**

ELETTROTEK KABEL Middle East Electrical Equipment trading L.L.C.

Beside TRA Building, Al Salam Street, Abu Dhabi,
United Arab Emirates, PO Box: 48238
Phone: +971 2 67 999 19
Fax: +971 2 67 999 29
Email: info@eletrotekkabel.ae

ELETTROTEK KABEL[®] **MIDDLE EAST**

ELETTROTEK KABEL Middle East DMCC

Unit 602, JBC2, plot JLT-PH2-V1A, Cluster V,
Jumeirah Lakes Towers, Dubai
United Arab Emirates PO Box 337077
Phone: +971 4 447 2551
Fax: +971 4 447 3690
Email: info@eletrotekkabel.ae

ELETTROTEK KABEL[®] **SWISS**

ELETTROTEK KABEL SWISS GmbH

Industriestrasse 18
8910 Affoltern am Albis - ZH - Switzerland
Phone: +41 (0) 44 760 36 80
Fax: +41 (0) 44 760 36 81
Email: contact@eletrotekkabel.ch

ELETTROTEK KABEL[®] **GERMANY**

ELETTROTEK KABEL GmbH

Erik-Geiershoefer-Str. 7
90584 Allersberg - Germany
Phone: +49 (0) 9176 36 797 46
Fax: +49 (0) 9176 36 797 47
Email: kontakt@eletrotekkabel.de

ELETTROTEK KABEL[®] **NORTH AMERICA**

ELETTROTEK KABEL NORTH AMERICA Inc.

2 Cranberry Road - Unit 5A
Parsippany, NJ - 07054 - USA
Phone: +1 973 265 0850
Fax: +1 973 265 0854
Email: info@eletrotekkabel.us

ELETTROTEK KABEL[®] **CANADA**

ELETTROTEK KABEL CANADA Inc.

1201 - 5th street SW - Suite 200
Calgary, AB T2R 0Y6 - Canada
Phone: +1 403 817 2050
Email: info@eletrotekkabel.ca

The Business Units:

STOCK:



FACTORY:

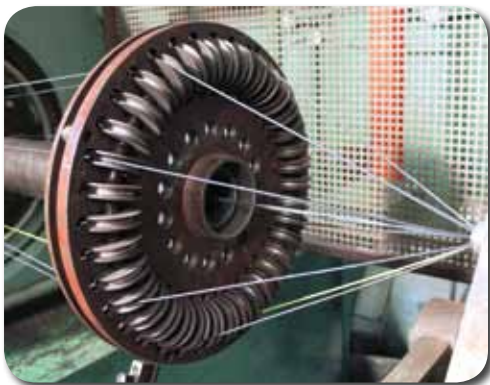

Certifications:

GOST-EAC



ISO 9001:2008



UL



CSA



Control and connection cables:

H05V-K / H07V-K	10
H05Z-K / H07Z-K	11
H05V2-K / H07V2-K	12
(H)05V-K/MTW/TEW, (H)07V-K/MTW/TEW	13
GAALFLEX® CONTROL 500	14/16
GAALFLEX® CONTROL 500 CY Lean	17/18
GAALFLEX® CONTROL 500 H	19/20
GAALFLEX® CONTROL 500 CH Lean	21/22
GAALFLEX® CONTROL 500 B	23/24
GAALFLEX® CONTROL 500 BH	25/26
GAALFLEX® CONTROL 501	27/28
GAALFLEX® CONTROL 501 CY	29/30
GAALFLEX® CONTROL 500 FL OR	31/33
GAALFLEX® CONTROL 500 FL OR CY	34/35
GAALFLEX® CONTROL 500 SY (TR)	36/37
GAALFLEX® CONTROL 500 P	38/39
GAALFLEX® CONTROL 500 P orange	40
GAALFLEX® CONTROL 500 CP Lean	41/42
GAALFLEX® CONTROL 540 P	43/44
GAALFLEX® CONTROL 540 CP	45/46
GAALFLEX® CONTROL 750 BCY Lean	47/48
GAALFLEX® CONTROL 1000	49/50
GAALFLEX® CONTROL 1000 H	51/52
GAALFLEX® CONTROL 1000 H SC	53
GAALFLEX® CONTROL 1000 BH SC	54
GAALFLEX® CONTROL 1000 BH	55/56
GAALFLEX® CONTROL 1000 SC CY	57
GAALFLEX® CONTROL 1000 CY	58/59
GAALFLEX® CONTROL 1000 CH	60/61
GAALFLEX® CONTROL 1000 P	62/63
GAALFLEX® CONTROL H05BQ-F	64
GAALFLEX® CONTROL 07BQ-F	65
GAALFLEX® CONTROL (H)07BQ-F	66
GAALFLEX® CONTROL H07ZZ-F	67/68
GAALFLEX® CONTROL 600	69/71
GAALFLEX® CONTROL 600 CY Lean	72/74
GAALFLEX® CONTROL 600 SC	75
GAALFLEX® CONTROL 600 SC CY	76
GAALFLEX® CONTROL 600 MTW	77/78
GAALFLEX® CONTROL 600 MTW CY Lean	79/80
GAALFLEX® CONTROL 601	81/83
GAALFLEX® CONTROL 601 CY	84/85
GAALFLEX® TRAY 600	86/87
GAALFLEX® TRAY 1002	88/89
GAALFLEX® TRAY 600 CY Lean	90/91
GAALFLEX® TRAY 1002 CY Lean	92/93
GAALFLEX® TRAY INSTRUMENTATION 600 POS	94
GAALFLEX® TRAY INSTRUMENTATION 600 SPOS	95
GAALFLEX® TRAY INSTRUMENTATION 600 TOS	96
GAALFLEX® TRAY INSTRUMENTATION 600 STOS	97

Gaalflex VFD cables:

GAALFLEX® VFD 2YSLCY-J	100/101
GAALFLEX® VFD 2YSLCYK-J	102/103
GAALFLEX® VFD 1000	104/105
GAALFLEX® VFD 1300 A	106/107
GAALFLEX® VFD 2XSLCYK-J	108/109
GAALFLEX® VFD 2XSLCHK-J	110/111
GAALFLEX® VFD 1100 PH	112/113
GAALFLEX® TRAY VFD 1500 T	114/115
GAALFLEX® TRAY VFD 1510 T	116/117
GAALFLEX® TRAY VFD 1520	118/119
GAALFLEX® TRAY VFD 1400	120/121
GAALFLEX® TRAY VFD 1405	122
GAALFLEX® TRAY VFD 1410	123/124
GAALFLEX® TRAY VFD 1420	125
GAALFLEX® VFD 9YSLCY-J and 9YSLCYK-J	126/127
GAALFLEX® VFD NYCWY	128/129
GAALFLEX® VFD 1000 P	130
GAALFLEX® VFD 1200	131
GAALFLEX® VFD FG7OHH2R	132
GAALFLEX® VFD FE4OHH2R	133/134
GAALFLEX® VFD FG7(O)CR	135
GAALFLEX® VFD FE4(O)CR	136
GAALFLEX® VFD EMV-FC 3GSEGCY	137/138
GAALFLEX® VFD EMV-FC 3GSEGCH	139/140
GAALFLEX® VFD EMV-FC 2XSEHCHRH	141
GAALFLEX® VFD 600	142

Gaalflex safe:

GAALFLEX® SAFE	144/145
GAALFLEX® SAFE CY Lean	146/147
GAALFLEX® SAFE CY TP	148/149

Data cables:

GAALFLEX® DATA LiYY	152/154
GAALFLEX® DATA LiYCY	155/157
GAALFLEX® DATA LiYCY-CY	158/159
GAALFLEX® DATA LiYCY (B) TP	160/161
GAALFLEX® DATA Li2YCY (TP) Pimf	162/163
GAALFLEX® DATA LiYY UL	164/165
GAALFLEX® DATA LiYCY UL	166/167
GAALFLEX® DATA LiYCY (B) TP UL	168/169
GAALFLEX® DATA LiHH	170/172
GAALFLEX® DATA LiHCH	173/175
GAALFLEX® DATA LiHCH (B) TP	176/177
GAALFLEX® DATA 300 CP	178/179
GAALFLEX® DATA 300 TP P	180/181
GAALFLEX® DATA 300 IN TP	182/183

Index

Track cables:

GAALFLEX® CHAIN TD 87.....	186
GAALFLEX® CHAIN T 87.....	187/188
GAALFLEX® CHAIN TD 87 C.....	189
GAALFLEX® CHAIN T 87 C Lean.....	190/191
GAALFLEX® CHAIN T 87 C.....	192/193
GAALFLEX® CHAIN TD 87 C TP.....	194/195
FLEXIDRUM® T 100.....	196
FLEXIDRUM® T 100 C.....	197
FLEXIDRUM® T 100 UL.....	198
FLEXIDRUM® T 100 C UL.....	199
FLEXIDRUM® T 101.....	200
FLEXIDRUM® T 101 C.....	201
FLEXIDRUM® T 101 UL.....	202
FLEXIDRUM® T 101 C UL.....	203
FLEXIDRUM® TD 200.....	204/205
FLEXIDRUM® T 200.....	206/208
FLEXIDRUM® TD 200 C.....	209/210
FLEXIDRUM® T 200 C.....	211/213
FLEXIDRUM® TD 200 C TP.....	214/215
GAALTHERM® 180.....	216
GAALTHERM® 180 C.....	217
GAALTHERM® 180 UL.....	218
GAALTHERM® 180 C UL.....	219
FLEXIDRUM® TD 210.....	220
FLEXIDRUM® T 210.....	221/222
FLEXIDRUM® TD 210 C.....	223
FLEXIDRUM® T 210 C.....	224/225
FLEXIDRUM® TD 210 C TP.....	226/227

Servo cables:

GAALFLEX® SERVOT 806 UL / T 806 C UL.....	230/231
GAALFLEX® SERVOT 807 C / T 808 C.....	232/233
SPECIAL GAALFLEX® SERVOT 830 / T 830 C.....	234/235
GAALFLEX® SERVOT 828 C.....	236
GAALFLEX® SERVOT 829 C.....	237
GAALFLEX® SERVOT 839 C.....	238/239
GAALFLEX® SERVOT 840 C.....	240
FLEXIDRUM® T 300.....	241
FLEXIDRUM® T 300 C.....	242
FLEXIDRUM® T 310.....	243
GAALFLEX® SERVOT 833 C.....	244
GAALFLEX® SERVOT 834 C.....	245
GAALFLEX® SERVOT 841 C.....	246/247
GAALFLEX® SERVOT 844 C.....	248/249

Torsion cables:

GAALFLEX® ROBOT 118.....	252/253
GAALFLEX® ROBOT 118 D.....	254
GAALFLEX® ROBOT 113.....	255/256
GAALFLEX® ROBOT 113 D.....	257
GAALFLEX® ROBOT 123.....	258/259
GAALFLEX® ROBOT 123 D.....	260/261

Profibus dp cables:

PROFIBUS 637.....	264
PROFIBUS 632.....	265
PROFIBUS 630 / PROFIBUS 631 PE.....	266
PROFIBUS 630 HALOGEN FREE / PROFIBUS 630 FRNC.....	267
PROFIBUS 633 PE / SPECIAL PROFIBUS 633.....	268
PROFIBUS 642.....	269
SPECIAL PROFIBUS 634.....	270
SPECIAL PROFIBUS 634 UL.....	271
SPECIAL PROFIBUS 644.....	272
SPECIAL PROFINET-BUS UL/CSA.....	273
SPECIAL MODBUS 660.....	274

Can-bus cables and Safety bus p cables:

CAN-BUS 620 / CAN-BUS 620 FRNC.....	276
CAN-BUS 627 UL.....	277
S CAN-BUS 626 / S CAN-BUS 625.....	278
S CAN-BUS 628 UL.....	279
SAFE 680.....	280
ASI CABLES.....	281
SAFETY 684 Move.....	282

Devicenet cables:

DEVICENET™ 650 / DEVICENET™ 651.....	284
DEVICENET™ 656 / DEVICENET™ 657.....	285
DEVICENET™ 658 / DEVICENET™ 659.....	286

Industrial ethernet cables:

PROFINET 654 / PROFINET 655.....	288
PROFINET 660 / PROFINET 661.....	289
PROFINET 662 / PROFINET 663 / PROFINET 663 PLTC.....	290
PROFINET 679.....	291
SPECIAL PROFINET 679 UL.....	292
PROFINET 678 / SPECIAL PROFINET 678 UL.....	293/294
SPECIAL PROFINET 668 / SPECIAL PROFINET 669.....	295
SPECIAL PROFINET 681 / SPECIAL PROFINET 682.....	296

Cable reels:

FLEXIDRUM® NSHTÖU.....	298/300
FLEXIDRUM® NSHTÖU -V	301/302
FLEXIDRUM® R 501	303
FLEXIDRUM® R 502	304/305
FLEXIDRUM® R 503	306/307
FLEXIDRUM® R 700	308
FLEXIDRUM® R 701 UL.....	309/310
FLEXIDRUM® R 702	311/312
FLEXIDRUM® SPECIAL R 702.....	313/314
FLEXIDRUM® R 703	315/316
FLEXIDRUM® MEDIUM R 902.....	317/318
FLEXIDRUM® MEDIUM R 902 OPTICAL FIBER.....	319/320
FLEXIDRUM® MEDIUM R 901	321
FLEXIDRUM® MEDIUM (N)TSCGEWÖU.....	322/324
FLEXIDRUM® MEDIUM (N)TSCGEWÖU OPTICAL FIBER.....	325/327
FLEXIDRUM® MEDIUM PLUS (N)TSCGEWÖU.....	328/330
FLEXIDRUM® MEDIUM PLUS (N)TSCGEWÖU OPTICAL FIBER.....	331/334
FLEXIDRUM® MEDIUM (N)TSCGEWÖU TUNNEL	335/337
FLEXIDRUM® MEDIUM R 903 TUNNEL.....	338/339
FLEXIDRUM® MEDIUM (N)TSCGEWÖU WATER	340/342
FLEXIDRUM® MEDIUM (N)TSCGEWÖU WATER.../3E	343/345
FLEXIDRUM® MEDIUM RS (N)TSCGEWÖU.....	346/348
FLEXIDRUM® MEDIUM RS (N)TSCGEWÖU with anti-twisting	349/351
FLEXIDRUM® MEDIUM RS-T (N)TSCGEWÖU	352/354
FLEXIDRUM® MEDIUM SHD-GC 8/15 kV	355/356
FLEXIDRUM® MEDIUM FLAT (N)TSFLCGCWOEUS	357/358
FLEXIDRUM® FIBER 770	359
FLEXIDRUM® FIBER 780	360

Festoon cables:

FLEXFESTOON® HF-FLAT.....	362
FLEXFESTOON® HF-FLAT CY	363
FLEXFESTOON® NE-FLAT (NGFLGÖU-J).....	364/365
FLEXFESTOON® NE-FLAT CY (N)GFLCGÖU.....	366
FLEXFESTOON® NE-FLAT (NGFLGÖU) UL.....	367/368
FLEXFESTOON® NE-FLAT M(S&D)HÖU-J/O UL.....	369/370
FLEXFESTOON® SPECIAL NE-FLAT.....	371/373
FLEXFESTOON® SPECIAL NE-FLAT CY	374/375
FLEXFESTOON® PV-FLAT (H07VVH6-F).....	376/377
FLEXFESTOON® PV-FLAT CY (VCVH6-F).....	378
FLEXFESTOON® PV-FLAT UL.....	379
H07RN-F.....	380/382
FLEXIFESTOON® SOOW	383/384
FLEXIFESTOON® SEOOW YELLOW	385
H07BN4-F.....	386/387
FLEXFESTOON® DLO	388
FLEXFESTOON® (N)GRDGÖU-J.....	389/390
FLEXFESTOON® (N)GRDGCGÖU-J.....	391/392
FLEXFESTOON® PUR.....	393/394
FLEXFESTOON® C PUR	395/396

Index

Pendant cables:

IIFT-2S	397
LIFT-1S UL	398
LIFT-2S UL	399

Basket cables:

BASKET SPREADER 730	400
BASKET SPREADER 740 (YSLTOE)	401/402

Lift cables:

COMBI/BASKET LIFT 731	404
PV-FLAT H05VVH6F/LIFT	405
ROUND LIFT 732	406/408
ROUND LIFT 733	409
PENDANT ROUND LIFT 733 UL	410
ROUND LIFT 734	411

Mining cables:

FLEXIMINING® R 400 WATER PROOF	414/415
FLEXIMINING® R 401 WATER PROOF	416
FLEXIMINING® R 500 VFD	417
FLEXIMINING® R 500 SWBA	418/419
FLEXIMINING® NSSHÖU	420/422
FLEXIMINING® (N)SHÖU	423/425
FLEXIMINING® (N)SSHÖU 3E/3E+ST/KON	426/427
FLEXIMINING® (N)SSHCÖU	428/429
FLEXIMINING® (N)SSHCGEÖU (V)	430/431
FLEXIMINING® (N)TSKCGEWÖU 1,8/3 kV and 3,6/6 kV	432/433
FLEXIMINING® (N)SSHCGEÖU (Z) REINFORCED VERSION	434
FLEXIMINING® MEDIUM (N)TMCWCWÖU 3,6/6 up to 12/24 kV	435/436
FLEXIMINING® MEDIUM (N)TMCWÖU 6/10 up to 20/35 kV	437/438
FLEXIMINING® MEDIUM NTMCWÖU WATER PROOF	439/440
FLEXIMINING® MEDIUM NTMCWÖU COLD 6/10 up to 20/35 kV	441/442
FLEXIMINING® MEDIUM NTMCWÖU 26/45 kV	443/444
FLEXIMINING® MEDIUM NTMCWÖU 76/132-138 kV	445
FLEXIMINING® MEDIUM F-(N)TSCGEWÖU	446/448
FLEXIMINING® MEDIUM F-(N)TSCGEWÖU OPTICAL FIBER	449/451
FLEXIMINING® MEDIUM R2XH1OZR	452
FLEXIMINING® MEDIUM R2XH1O(GS)E	453
FLEXIMINING® MEDIUM (N)3GHSSYCY	454/455
FLEXIMINING® SIGNAL 2YSLGCÖU	456
TECHNICAL DATA	459/518

APPLICATIONS SPEED TABLE AND MINIMUM BENDING RADIUS

(Values are valid only after check and confirmation of the application by Elettrotek Kabel Group Technical dept.)

















































APPLICATIONS SPEED TABLE

(Values are valid only after check and confirmation of the application by Elettrotek Kabel Group Technical dept.)

ELETTROTEKKABEL types	Main application	Secondary application	Reeling speed max.	Festoon speed max.	Chain speed max.	Basket speed max.
GAALFLEX® CHAIN TD 87					180 m/min	
GAALFLEX® CHAIN T 87					180 m/min	
GAALFLEX® CHAIN TD 87 C					180 m/min	
GAALFLEX® CHAIN T 87 C Lean					180 m/min	
GAALFLEX® CHAIN T 87 C					180 m/min	
GAALFLEX® CHAIN TD 87 C TP					180 m/min	
FLEXIDRUM® T 100-101 (UL)				240 m/min	250 m/min	
FLEXIDRUM® T 100-101 C (UL)				240 m/min	250 m/min	
FLEXIDRUM® T 200 -T 210 FLEXIDRUM® TD 200 -TD 210				240 m/min	250 m/min	
FLEXIDRUM® T 200 C - T 210 C FLEXIDRUM® TD 200 C - TD 210 C				240 m/min	250 m/min	
FLEXIDRUM® TD 200 C TP - TD 210 C TP				240 m/min	250 m/min	
SPECIAL GAALFLEX® SERVO T 830 - T 830 C					Unsupported: 8 m/sec Gliding: 4 m/sec	
GAALFLEX® SERVO T 839 C					250 m/min	
GAALFLEX® SERVO T 840 C					250 m/min	
FLEXIDRUM® T 300					250 m/min	
FLEXIDRUM® T 300 C					250 m/min	
FLEXIDRUM® T 310					250 m/min	
GAALFLEX® SERVO T 833 C					250 m/min	
GAALFLEX® SERVO T 834 C					300 m/min	
GAALFLEX® SERVO T 841 C					250 m/min	
GAALFLEX® SERVO T 844 C					300 m/min	
SPECIAL PROFIBUS 634				240 m/min	250 m/min	
SPECIAL PROFIBUS 634 UL				240 m/min	250 m/min	
SPECIAL PROFIBUS 644				240 m/min	250 m/min	















APPLICATIONS SPEED TABLE

(Values are valid only after check and confirmation of the application by Elettrotek Kabel Group Technical dept.)

ELETTROTEKKABEL types	Main application	Secondary application	Reeling speed max.	Festoon speed max.	Chain speed max.	Basket speed max.
SPECIAL PROFINET-BUS UL/CSA				240 m/min	250 m/min	
S CAN-BUS 626 - S CAN-BUS 625				240 m/min	250 m/min	
S CAN-BUS 628				240 m/min	250 m/min	
SPECIAL PROFINET 681 SPECIAL PROFINET 682				240 m/min	250 m/min	
FLEXIDRUM® NSHTÖU			180 m/min	240 m/min		
FLEXIDRUM® NSHTÖU-V			240 m/min	240 m/min		
FLEXIDRUM® R 501			60 m/min			
FLEXIDRUM® R 502			180 m/min (with A/T) 30 m/min (without A/T)			
FLEXIDRUM® R 503			180 m/min	240 m/min		
FLEXIDRUM® R 700			250 m/min			
FLEXIDRUM® R 701 UL			250 m/min			
FLEXIDRUM® R 702			120 m/min			
FLEXIDRUM® SPECIAL R 702			120 m/min			
FLEXIDRUM® R 703			120 m/min			
FLEXIDRUM® MEDIUM R 902			120 m/min			
FLEXIDRUM® MEDIUM R 902 Optical fiber			120 m/min			
FLEXIDRUM® MEDIUM R 901			60 m/min			
FLEXIDRUM® MEDIUM (N)TSCGEWÖU			180 m/min	120 m/min		
FLEXIDRUM® MEDIUM (N)TSCGEWÖU Optical fiber			180 m/min	120 m/min		
FLEXIDRUM® MEDIUM PLUS (N)TSCGEWÖU			300 m/min			
FLEXIDRUM® MEDIUM PLUS (N)TSCGEWÖU Optical fiber			300 m/min			
FLEXIDRUM® MEDIUM (N)TSCGEWÖU TUNNEL			60 m/min			
FLEXIDRUM® MEDIUM R 903			60 m/min			
FLEXIDRUM® MEDIUM RS (N)TSCGEWÖU			60 m/min			
FLEXIDRUM® MEDIUM RS (N)TSCGEWÖU with anti-twisting protection			180 m/min			



APPLICATIONS SPEED TABLE

(Values are valid only after check and confirmation of the application by Elettrotek Kabel Group Technical dept.)

ELETTROTEKKABEL types	Main application	Secondary application	Reeling speed max.	Festoon speed max.	Chain speed max.	Basket speed max.
FLEXIDRUM® MEDIUM RS-T (N)TSCGEWÖU			240 m/min			
FLEXIDRUM® FIBER 770			120 m/min	240 m/min	240 m/min	
FLEXIDRUM® FIBER 780			120 m/min	240 m/min	240 m/min	
FLEXIFESTOON® HF-FLAT				120 m/min		
FLEXIFESTOON® HF-FLAT CY				120 m/min		
FLEXIFESTOON® NE-FLAT (NGFLGÖU-J)				180 m/min		
FLEXIFESTOON® NE-FLAT CY (N)GFLCGÖU				180 m/min		
FLEXIFESTOON® NE-FLAT (NGFLGÖU) UL				180 m/min		
FLEXIFESTOON® NE-FLAT M (StD) HÖU-J/O UL				180 m/min		
FLEXIFESTOON® SPECIAL NE-FLAT				180 m/min		
FLEXIFESTOON® SPECIAL NE-FLAT CY				180 m/min		
FLEXIFESTOON® PV-FLAT (H07VVH6-F)				120 m/min		
FLEXIFESTOON® PV-FLAT CY (VCVH6-F)				120 m/min		
FLEXIFESTOON® PV-FLAT UL				120 m/min		
FLEXIFESTOON® (N)GRDGÖU-J				240 m/min		
FLEXIFESTOON® (N)GRDGCÖU-J				240 m/min		
FLEXIFESTOON® PUR				240 m/min		
FLEXIFESTOON® C PUR				240 m/min	180 m/min	
BASKET SPREADER 730 (3GRDGOU)						160 m/min
BASKET SPREADER 740 (YSLTOE)						160 m/min
COMBI/BASKET LIFT 731						250 m/min
PV-FLAT H05VVH6F/LIFT				120 m/min		
FLEXIMINING® MEDIUM F-(N)TSCGEWÖU	flexible/fixed use		100 m/min			
FLEXIMINING® MEDIUM F-(N)TSCGEWÖU Optical fiber	flexible/fixed use		100 m/min			

MINIMUM BENDING RADIUS

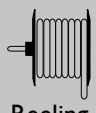
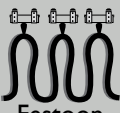
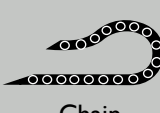
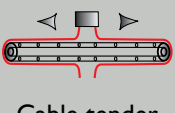

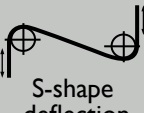

(Values are valid only after check and confirmation of the application by Elettrotek Kabel Group Technical dept.)

ELETTROTEKKABEL cables	Fixed	Reeling 	Festoon 	Chain 	Cable tender 	Deflection pulleys 	S-shape deflection 
GAALFLEX® CHAIN TD 87	5 x d			7,5 x d			
GAALFLEX® CHAIN T 87	4 x d			7,5 x d			
GAALFLEX® CHAIN TD 87 C	5 x d			7,5 x d			
GAALFLEX® CHAIN T 87 C lean	4 x d			8 x d			
GAALFLEX® CHAIN T 87 C	5 x d			7,5 x d			
GAALFLEX® CHAIN TD 87 C TP	5 x d			7,5 x d			
FLEXIDRUM® T 100-101 (UL)	3 x d		7,5 x d	7,5 x d			
FLEXIDRUM® T 100-101 C (UL)	4 x d		7,5 x d	7,5 x d			
FLEXIDRUM® TD 200	3 x d		5 x d	5 x d			
FLEXIDRUM® T 200	3 x d		5 x d	5 x d			
FLEXIDRUM® T 200 C	4 x d		7,5 x d	7,5 x d			
FLEXIDRUM® TD 200 C TP	4 x d		7,5 x d	7,5 x d			
GAALTHERM® 180 & 180 UL	5 x d		10 x d	10 x d			
GAALTHERM® 180 C & 180 C UL	5 x d		15 x d	15 x d			
FLEXIDRUM® TD 210	3 x d		5 x d	5 x d			
FLEXIDRUM® T 210	3 x d		5 x d	5 x d			
FLEXIDRUM® T 210 C	4 x d		7,5 x d	7,5 x d			
FLEXIDRUM® TD 210 C TP	5 x d		7,5 x d	7,5 x d			
SPECIAL GAALFLEX® SERVO T 830 - T 830 C	4 x d			7,5 x d			
GAALFLEX® SERVO T 839 C	5 x d		10 x d	12 x d			
GAALFLEX® SERVO T 840 C	5 x d		7 x d	7 x d			
FLEXIDRUM® T 300	4 x d		6 x d	10 x d			
FLEXIDRUM® T 300 C	4 x d		6 x d	10 x d			
FLEXIDRUM® T 310	4 x d		6 x d	10 x d			
GAALFLEX® SERVO T 833 C	5 x d		10 x d	12 x d			
GAALFLEX® SERVO T 834 C	5 x d		7 x d	7 x d			
GAALFLEX® SERVO T 841 C	5 x d		10 x d	12 x d			
GAALFLEX® SERVO T 844 C	5 x d		7 x d	7 x d			
SPECIAL PROFIBUS 634	10 x d		12 x d	12 x d			
SPECIAL PROFIBUS 634 UL	10 x d		15 x d	15 x d			
SPECIAL PROFIBUS 644	10 x d		15 x d	15 x d			
SPECIAL PROFINET-BUS UL/CSA	10 x d		15 x d	15 x d			
FLEXIDRUM® NSHTÖU	3 x d* 4 x d	5 x d	4 x d* 5 x d	4 x d* 5 x d	7,5 x d	7,5 x d	20 x d
FLEXIDRUM® NSHTÖU-V	3 x d* 4 x d	5 x d	4 x d* 5 x d	4 x d* 5 x d	7,5 x d	7,5 x d	20 x d

Note: (*) refer to DIN VDE 0298 part 3, pag 503.

MINIMUM BENDING RADIUS

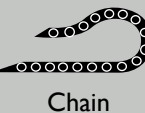
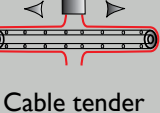

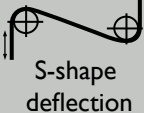

(Values are valid only after check and confirmation of the application by Elettrotek Kabel Group Technical dept.)

ELETTROTEKKABEL cables	     						
	Fixed	Reeling	Festoon	Chain	Cable tender	Deflection pulleys	S-shape deflection
FLEXIDRUM® R 501	6 x d	10 x d	10 x d	10 x d		10 x d	
FLEXIDRUM® R 502	3 x d* 4 x d	5 x d	4 x d* 5 x d	4 x d* 5 x d	7,5 x d	7,5 x d	
FLEXIDRUM® R 503	5 x d	7,5 x d	7,5 x d	7,5 x d			
FLEXIDRUM® R 700	3 x d* 4 x d	5 x d	4 x d* 5 x d	4 x d* 5 x d	7,5 x d	7,5 x d	
FLEXIDRUM® R 701 UL	3 x d* 4 x d	5 x d	4 x d* 5 x d	4 x d* 5 x d	7,5 x d	7,5 x d	
FLEXIDRUM® SPECIAL R 702	3 x d* 4 x d	6 x d	6 x d	6 x d	7,5 x d	7,5 x d	
FLEXIDRUM® R 703	4 x d	6 x d	6 x d	6 x d	7,5 x d	7,5 x d	
FLEXIDRUM® MEDIUM R 902	3 x d* 4 x d	5 x d	4 x d* 5 x d	4 x d* 5 x d	7,5 x d	7,5 x d	
FLEXIDRUM® MEDIUM R 902 Optical fiber	3 x d* 4 x d	5 x d	4 x d* 5 x d	4 x d* 5 x d	7,5 x d	7,5 x d	
FLEXIDRUM® MEDIUM R 901		10 x d	10 x d	10 x d	15 x d	15 x d	20 x d
FLEXIDRUM® MEDIUM (N)TSCGEWÖU	6 x d	12 x d	12 x d	12 x d	15 x d	15 x d	20 x d
FLEXIDRUM® MEDIUM (N)TSCGEWÖU Optical fiber	6 x d	12 x d	12 x d	12 x d	15 x d	15 x d	20 x d
FLEXIDRUM® MEDIUM PLUS (N)TSCGEWÖU	6 x d	12 x d	12 x d	12 x d	15 x d	15 x d	20 x d
FLEXIDRUM® MEDIUM PLUS (N)TSCGEWÖU Optical fiber	6 x d	12 x d	12 x d	12 x d	15 x d	15 x d	20 x d
FLEXIDRUM® MEDIUM (N)TSCGEWÖU TUNNEL	6 x d	12 x d	12 x d	12 x d	15 x d	15 x d	20 x d
FLEXIDRUM® MEDIUM R 903 TUNNEL	8 x d	10 / 12 x d	10 / 12 x d	10 / 12 x d	10 / 12 x d	10 / 12 x d	
FLEXIDRUM® MEDIUM (N)TSCGEWÖU WATER	3 x d* 4 x d	5 x d	4 x d* 5 x d	4 x d* 5 x d	7,5 x d	7,5 x d	
FLEXIDRUM® MEDIUM (N)TSCGEWÖU WATER...3E	3 x d* 4 x d	5 x d	4 x d* 5 x d	4 x d* 5 x d	7,5 x d	7,5 x d	
FLEXIDRUM® MEDIUM RS (N)TSCGEWÖU	6 x d	12 x d	12 x d	12 x d	15 x d	15 x d	20 x d
FLEXIDRUM® MEDIUM RS (N)TSCGEWÖU with anti-twisting protection	6 x d	12 x d	12 x d	12 x d	15 x d	15 x d	20 x d
FLEXIDRUM® MEDIUM RS-T (N)TSCGEWÖU	3 x d* 4 x d	5 x d	4 x d* 5 x d	4 x d* 5 x d	7,5 x d	7,5 x d	
FLEXIDRUM® MEDIUM SHD-GC 8/15 kV	8 x d						
FLEXIDRUM® MEDIUM FLAT (N)TSFLGCWÖEUS	3 x d* 4 x d	5 x d	4 x d* 5 x d	4 x d* 5 x d	7,5 x d	7,5 x d	20 x d
FLEXIDRUM® FIBER 770	100 mm	125 mm	125 mm	125 mm	200 mm	200 mm	500 mm
FLEXIDRUM® FIBER 780	6 x d	10 x d	10 x d	10 x d	15 x d	15 x d	20 x d
FLEXIFESTOON® HF-FLAT	10 x d		10 x d				
FLEXIFESTOON® HF-FLAT CY	10 x d		10 x d				
FLEXIFESTOON® (NGFLGÖU) NE-FLAT	3 x d* 4 x d	5 x d	4 x d* 5 x d	4 x d* 5 x d	7,5 x d	7,5 x d	
FLEXIFESTOON® NE-FLAT CY (N)GFLCGÖU	3 x d* 4 x d	5 x d	4 x d* 5 x d	4 x d* 5 x d	7,5 x d	7,5 x d	
FLEXIFESTOON® NE-FLAT (NGFLGÖU) UL	3 x d* 4 x d	5 x d	4 x d* 5 x d	4 x d* 5 x d	7,5 x d	7,5 x d	
FLEXIFESTOON® NE-FLAT M(SID)HÖU-J/O UL	3 x d* 4 x d	5 x d	4 x d* 5 x d	4 x d* 5 x d	7,5 x d	7,5 x d	
FLEXIFESTOON® SPECIAL NE-FLAT	10 x d		10 x d				
FLEXIFESTOON® SPECIAL NE-FLAT CY	10 x d		10 x d				
FLEXIFESTOON® PV-FLAT (H07VVH6-F)	3 x d* 4 x d	5 x d	4 x d* 5 x d	4 x d* 5 x d	7,5 x d	7,5 x d	

Note: (*) refer to DIN VDE 0298 part 3, pag 503.

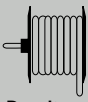
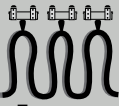
MINIMUM BENDING RADIUS

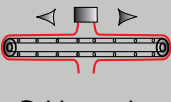

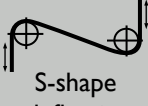
(Values are valid only after check and confirmation of the application by Elettrotek Kabel Group Technical dept.)

ELETTROTEKKABEL cables	Fixed	Reeling 	Festoon 	Chain 	Cable tender 	Deflection pulleys 	S-shape deflection 
FLEXIFESTOON® PV-FLAT CY (VCVH6-F)			10 x d				
FLEXIFESTOON® PV-FLAT UL			10 x d				
H07RN-F	3 x d* 4 x d	5 x d	4 x d* 5 x d	4 x d* 5 x d	7,5 x d	7,5 x d	
FLEXIFESTOON® SOOW	4 x d		4 x d				
FLEXIFESTOON® SEOOW YELLOW	4 x d		4 x d				
H07BN4-F	3 x d		6 x d				
FLEXIFESTOON® DLO	4 x d						
FLEXIFESTOON® (N)GRDGEOU-J	3 x d* 4 x d	5 x d	4 x d* 5 x d	4 x d* 5 x d	7,5 x d	7,5 x d	20 x d
FLEXIFESTOON® (N)GRDGC GEOU-J	3 x d* 4 x d	5 x d	4 x d* 5 x d	4 x d* 5 x d	7,5 x d	7,5 x d	20 x d
FLEXIFESTOON® PUR	4 x d		6 x d				
FLEXIFESTOON® C PUR	4 x d		6 x d				
FLEXIMINING® R 400 WATER PROOF	4 x d	6 x d					
FLEXIMINING® R 401 WATER PROOF	6 x d	8 x d					
FLEXIMINING® R 500 VFD	6 x d	8 x d					
FLEXIMINING® R 500 SWBA	6 x d	8 x d					
FLEXIMINING® NSSHÖU	4 x d	5 x d					
FLEXIMINING® (N)SHÖU	4 x d	5 x d					
FLEXIMINING® NSSHÖU 3E/3E+ST/KON	4 x d	5 x d					
FLEXIMINING® NSSHCÖU	3 x d* 4 x d	5 x d	4 x d* 5 x d	4 x d* 5 x d	7,5 x d	7,5 x d	
FLEXIMINING® NSSHCGEÖU(V) 0,6/1 kV	3 x d* 4 x d	5 x d	4 x d* 5 x d	4 x d* 5 x d	7,5 x d	7,5 x d	
FLEXIMINING® NTSKCGEWÖU 1,8/3 kV and 3,6/6 kV	3 x d* 4 x d	5 x d	4 x d* 5 x d	4 x d* 5 x d	7,5 x d	7,5 x d	
FLEXIMINING® NSSHCGEÖU(Z) REINFORCED VERSION	4 x d						
FLEXIMINING® MEDIUM NTMCGWÖU	3 x d* 4 x d	5 x d	4 x d* 5 x d	4 x d* 5 x d	7,5 x d	7,5 x d	
FLEXIMINING® MEDIUM NTMCWÖU 6/10 up to 20/35 kV	5 x d	10 x d					
FLEXIMINING® MEDIUM NTMCWÖU WATER PROOF 6/10 up to 12/20 kV	5 x d	10 x d					
FLEXIMINING® MEDIUM NTMCWÖU COLD 6/10 up to 20/35 kV	5 x d	10 x d					
FLEXIMINING® MEDIUM NTMCWÖU 26/45 kV	5 x d	10 x d					
FLEXIMINING® MEDIUM NTMCWÖU 72/132-138 kV	5 x d	10 x d					

Note: (*) refer to DIN VDE 0298 part 3, pag 503.

MINIMUM BENDING RADIUS

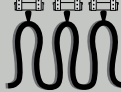
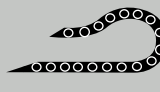
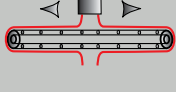
(Values are valid only after check and confirmation of the application by Elettrotek Kabel Group Technical dept.)

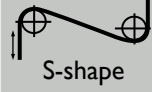
ELETTROTEKKABEL cables	Fixed	 Reeling	 Festoon	 Chain	 Cable tender	 Deflection pulleys	 S-shape deflection
FLEXIMINING® MEDIUM	3 x d*						
F-(N)TSCGEWÖU	4 x d	5 x d	4 x d*	4 x d*	7,5 x d	7,5 x d	
FLEXIMINING® MEDIUM	3 x d*	5 x d	4 x d*	4 x d*	7,5 x d	7,5 x d	
F-(N)TSCGEWÖU Optical fiber	4 x d		5 x d	5 x d			
FLEXIMINING® SIGNAL	3 x d*	5 x d	4 x d*	4 x d*	7,5 x d	7,5 x d	
2YSLGCÖU	4 x d		5 x d	5 x d			

Note: (*) refer to DIN VDE 0298 part 3, pag 503.

CONTROL AND CONNECTION CABLES



CONTROL AND CONNECTION CABLES

GAALFLEX® CONTROL H05V-K GAALFLEX® CONTROL H07V-K PVC insulated single conductor 300/500 V and 450/750 V

HAR

ELETTROTEK KABEL® H05V-K

Construction:

Conductor: flexible red copper conductor Cl.5, acc.to IEC 60228, CEI-EN 60228, DIN VDE 0295, HD 383

Outer sheath: black (RAL 9005),PVC,type T11, for the other coloration,see technical data (PAG.462)

Resistance:



Flame retardant and Self-extinguishing acc. to:
IEC 60332-1-2
EN 60332-1-2
CEI 20-25
BS 6004

Technical data:

Nominal voltage

H05V-K: U₀/U 300/500 V

H07V-K: U₀/U 450/750 V

Test voltage

H05V-K: 2 kV

H07V-K: 2,5 kV

Temperature range: - 10 °C / + 70 °C

Min. bending radius

Fixed laying: D<8<=3D D<12<=3D D>12<=4D

Near terminal: D<8<=2D D<12<=3D D>12<=4D

Features:

flexible conductor

harmonized acc. to European standards

insulation material acc. to
CEI 20-107/2-31 EN 50525-2-31(HD 21.4 S3, HD 21.4 S3/A1)

tests on materials acc. to CEI 20-107/2-1
(EN 50525-1, HD 21.1. S4), CEI 20-84 (EN 50396 HD 21.2 S3),
CEI 20-34 (IEC 60811 HD 505)

<HAR> H05V-K, H07V-K

RoHS and CE approval



H05V-K

Part no.	No.of cores x cross section n x mm ²	Outer-Ø ca.mm ± 10%	Copper weight kg/km	Cable weight approx. kg/km	AWG no.)*
31320D01010M05	0,5	2,3	4,8	10	20
31320D01010M07	0,75	2,4	7,2	12	19
31320D01010M10	1	2,6	9,6	15	18

H07V-K

Part no.	No.of cores x cross section n x mm ²	Outer-Ø ca.mm ± 10%	Copper weight kg/km	Cable weight approx. kg/km	AWG no.)*
31320E01010M15	1x1,5	3,1	14,4	21	16
31320E01010M25	1x2,5	3,8	24	32	14
31320E01010M40	1x4	4,4	38,4	47	12
31320E01010M60	1x6	4,9	57,6	65	10
31320E01010M61	1x10	6,4	96	110	8
31320E01010M62	1x16	7,4	153,6	170	6
31320E01010M63	1x25	9,1	240	255	4
31320E01010M64	1x35	10,4	336	345	2
31320E01010M65	1x50	12,4	480	495	1
31320E01010M66	1x70	13,6	672	690	2/0
31320E01010M67	1x95	15,8	912	935	3/0
31320E01010M68	1x120	17,4	1152	1185	4/0
31320E01010M69	1x150	19,8	1440	1480	250 MCM
31320E01010M70	1x185	21,6	1776	1920	350 MCM
31320E01010M71	1x240	24,6	2304	2350	450 MCM

Other dimensions and colours available on request.

CONTROL AND CONNECTION CABLES

GAALFLEX® CONTROL H05Z-K GAALFLEX® CONTROL H07Z-K

Halogen free, insulated single conductor 300/500 V and 450/750 V



ELETTROTEK KABEL® H05Z-K

Construction:

- Conductor:** flexible red copper conductor Cl.5, acc.to IEC 60228, DIN VDE 0295
- Outer sheath:** black (RAL 9005), XLPO type EI5 for the other coloration, see technical data (PAG.462)

Technical data:

Nominal voltage

- H05Z-K:** U₀/U 300/500 V
- H07Z-K:** U₀/U 450/750 V

Test voltage

- H05Z-K:** 2 kV acc.to DIN VDE 0281 part 2 + HD 21.2
- H07Z-K:** 2,5 kV acc.to DIN VDE 0281 part 2 + HD 21.2

Temperature range: - 40 °C / + 90 °C

Min. bending radius: 8 x d

Resistance:



Flame retardant and Self-extinguishing acc. to:
DIN VDE 0482 part 332-1-2
IEC 60332-1-2



Halogen free acc. to:
DIN VDE 0482 part.267-2
EN 50267-2-1
IEC 60754-1



Smoke density acc. to:
IEC 61034-1-2

Features:

- Halogen-free
- flexible conductor
- harmonized acc. to European standards
- <HAR> H05V-K, H07V-K
- according to DIN VDE 0282-9
- RoHS and CE approval



H05Z-K

Part no.	No.of cores x cross section n x mm ²	Outer-Ø ca.mm ± 10%	Copper weight kg/km	Cable weight approx. kg/km	AWG no.*)
31490D01010M05	0,5	2,3	4,8	9	20
31490D01010M07	0,75	2,4	7,2	12,4	19
31490D01010M10	1	2,6	9,6	15	18

H07Z-K

Part no.	No.of cores x cross section n x mm ²	Outer-Ø ca.mm ± 10%	Copper weight kg/km	Cable weight approx. kg/km	AWG no.*)
31490E01010M15	1,5	3,5	14,4	24	16
31490E01010M25	2,5	4	24	35	14
31490E01010M40	4	4,8	38	51	12
31490E01010M60	6	6	58	71	10
31490E01010M61	10	6,7	96	118	8
31490E01010M62	16	8,2	154	180	6
31490E01010M63	25	10,2	240	278	4
31490E01010M64	35	11,5	336	375	2
31490E01010M65	50	13,6	480	560	1

Other dimensions and colors available on request.

CONTROL AND CONNECTION CABLES

GAALFLEX® CONTROL H05V2-K GAALFLEX® CONTROL H07V2-K

PVC insulated single conductor 300/500V, 450/750V and 600V for UL/CSA



ELETTROTEK KABEL® H05V2-K

Construction:

Conductor: flexible tinned copper conductor Cl. 5, acc to IEC 60228, DIN VDE 0295

Outer sheath: black (RAL 9005), PVC type T13 for the other coloration, see technical data (PAG.462)

Technical data:

Nominal voltage:

DIN VDE:

H052V-K: U₀/U 300/500 V

H07V2-K: U₀/U 450/750 V

UL/CSA: 600 V

Test voltage: 2,5 kV

Temperature range

Fixed laying: **DIN VDE:** -20°C up to +90°C

UL/CSA: up to +105°C

Flexible application: **DIN VDE:** -5° Cup to +90°C

UL/CSA: up to +105°C

Min. bending radius: 4 x d

Resistance:



Flame retardant acc. to:

DIN VDE 0482 part 265-2-1
EN 50265-2-1
IEC 60332-1-2
UL1581 UL VW-1, CSA FT 1

Features:

flexible conductor

harmonized acc. to European standards

<HAR> H052V-K, H07V2-K

AWM style 1015 105°C 600 V
CSA type TEW 105°C 600 V FT1 CE

on request AWM style 1569 105°C 300 V
CSA type TEW 105°C 300 V FT1 CE

on request AWM style 1007 80°C 300 V
CSA type TEW 80°C 300 V FT1 CE

RoHS and CE approval



H05V2-K UL/CSA/CE

Part no.	No. of cores x cross section n x mm ²	Outer-Ø ca. mm ± 10%	Copper weight kg/km	Cable weight approx. kg/km	AWG no. *)
31330F01010A20	0,5	2,5	5,1	11	20
31330F01010A19	0,75	2,7	7,2	14	19
31330F01010A18	1	2,8	9,6	16	18

H07V2-K UL/CSA/CE

Part no.	No. of cores x cross section n x mm ²	Outer-Ø ca. mm ± 10%	Copper weight kg/km	Cable weight approx. kg/km	AWG no. *)
31330F01010A16	1,5	3,1	14,4	20	16
31330F01010A14	2,5	3,7	24	32	14
31330F01010A12	4	4,3	38,4	50	12
31330F01010A10	6	4,8	57,6	66	10
31330F01010A08	10	6,8	96	121	8
31330F01010A06	16	9,1	153,6	211	6
31330F01010A04	25	10,6	240	303	4
31330F01010A02	35	11,8	336	407	2

07V2-K UL/CSA/CE

Part no.	No. of cores x cross section n x mm ²	Outer-Ø ca. mm ± 10%	Copper weight kg/km	Cable weight approx. kg/km	AWG no. *)
31330F01010A01	50	14,2	480	600	1
31330F01010A2C	70	16,2	672	790	2/0
31330F01010A3C	95	17,3	912	1067	3/0
31330F01010A4C	120	19,2	1152	1277	4/0

Other dimensions and colors available on request.

CONTROL AND CONNECTION CABLES

GAALFLEX® CONTROL H05V2-K/MTW/TEW GAALFLEX® CONTROL H07V2-K/MTW/TEW

PVC insulated single conductor 300/500 V, 450/750 V and 600 V for UL/CSA



ELETTROTEK KABEL® H05V2-K/MTW/TEW

Construction:

Conductor: flexible tinned copper conductor Cl. 5, acc to IEC 60228, DIN VDE 0295

Outer sheath: black (RAL 9005), special PVC compound for the other coloration, see technical data (PAG.462)

Resistance:



Flame retardant and Self-extinguishing acc. to:
DIN VDE 0482 part 265-2-1
EN 50265-2-1
IEC 60332-1-2
UL1581 UL VW-1, CSA FT 1

Technical data:

Nominal voltage:

DIN VDE

H052V-K: U₀/U 300/500 V

H07V2-K: U₀/U 450/750 V

UL/CSA: 600 V

Test voltage: 2,5 kV

Temperature range

Fixed laying: **DIN VDE:** -40°C up to +90°C
UL/CSA: up to +105°C

Flexible application: **DIN VDE:** -5°C up to +90°C
UL/CSA: up to +105°C

Min. bending radius:

Fixed laying: 5 x d

Flexible application: 10 x d

Features:

flexible conductor

harmonized acc. to European standards

<HAR> H052V-K, H07V2-K

MTW 1063 (machine tool wire) acc. to NFPA 70

CSA TEW (thermoplastic Equipment Wire) 105°C

AWM style 1015 105°C 600 V
CSA type TEW 105°C 600 V FT1 CE

(^U) type MTW or AWM style 1015 105°C 600 V
VW1 CSA type TEW 105°C 600 V FT1 CE

RoHS and CE approval



H05V2-K UL/CSA/CE

Part no.	AWG no.*)	Outer-Ø ca.mm ± 10%	Copper weight kg/km	Cable weight approx. kg/km	No. of cores x cross section n x mm ²
31350F01010A24	22/7	2,3	3,5	7	0,35
31350F01010A22	22	2,5	4,8	9	0,55
31350F01010A20	20	2,7	7,2	11	0,83
31350F01010A18	18	2,9	9,6	14	1

H07V2-K UL/CSA/CE

Part no.	AWG no.*)	Outer-Ø ca.mm ± 10%	Copper weight kg/km	Cable weight approx. kg/km	No. of cores x cross section n x mm ²
31350F01010A16	16	3,1	14,4	19	1,5
31350F01010A14	14	3,6	24	31	2,5
31350F01010A12	12	4,2	38,4	46	4
31350F01010A10	10	4,8	58	66	6
31350F01010A08	8	6,5	96	112	10
31350F01010A04	4	9,8	240	267	25
31350F01010A02	2	11,3	336	346	35
31350F01010A4C	4/0	19,2	1152	1277	120

07V2-K UL/CSA/CE

Part no.	AWG no.*)	Outer-Ø ca.mm ± 10%	Copper weight kg/km	Cable weight approx. kg/km	No. of cores x cross section n x mm ²
31350F01010A06	6	8,6	154	187	16
31350F01010A01	1	13,5	480	516	50
31350F01010A2C	2/0	15,6	672	707	70
3 1350F01010A3C	3/0	17,8	912	935	95

Other dimensions and colors available on request.

CONTROL AND CONNECTION CABLES

GAALFLEX® CONTROL 500

PVC control cable (former = YSLY-JZ) 300/500 V

ELETTROTEK KABEL® GAALFLEX® CONTROL 500



Construction:

Conductor:	flexible red copper conductor Cl.5, acc.to IEC 60228, DIN VDE 0295
Insulation:	special PVC compound
Colour cores:	black cores with consecutive numbers acc. to EN 50334, green-yellow from 3 cores
Stranding:	in layers
Outer sheath:	grey (RAL 7001) special PVC compound

Resistance:



Flame retardant and Self-extinguishing acc. to:
DIN VDE 0482 part 265-2-1
EN 50265-2-1
IEC 60332-1-2



Oil resistance acc. to:
DIN VDE 0473 part 811-2-1
IEC EN 60811-2-1
UL 758 80°C

Technical data:

Nominal voltage:	U ₀ /U 300/500 V
Test voltage:	4 kV
Temperature range	
<i>Fixed laying:</i>	-40°C up to +80°C
<i>Flexible application:</i>	-15°C up to +80°C
Min. bending radius:	4 x d

Features:

flexible
numbered cores
small bending radius
on request black outer sheath
RoHS and CE approval



Part no.	No. of cores x cross section n x mm ²	Outer-Ø ca.mm ± 10%	Copper weight kg/km	Cable weight approx. kg/km	AWG no.®)
31010D51020M05	2 x 0,5	4,7	9,6	37	20
31010D50031M05	3 G 0,5	4,9	14,4	43	20
31010D50041M05	4 G 0,5	5,3	19,2	52	20
31010D50051M05	5 G 0,5	5,7	24	64	20
31010D50071M05	7 G 0,5	6,7	33,6	80	20
31010D50081M05	8 G 0,5	7,0	38,4	99	20
31010D50091M05	9 G 0,5	7,6	43,2	110	20
31010D50101M05	10 G 0,5	8,1	48	117	20
31010D50121M05	12 G 0,5	8,6	57,6	132	20
31010D50141M05	14 G 0,5	9	67,2	148	20
31010D50161M05	16 G 0,5	9,5	76,8	171	20
31010D50181M05	18 G 0,5	10,4	86,4	189	20
31010D50211M05	21 G 0,5	10,9	100,8	225	20
31010D50251M05	25 G 0,5	12,1	120	260	20
31010D50301M05	30 G 0,5	12,6	144	298	20
31010D50341M05	34 G 0,5	13,8	163,2	341	20
31010D50401M05	40 G 0,5	14,8	192	399	20
31010D50421M05	42 G 0,5	15,2	201,6	414	20
31010D50501M05	50 G 0,5	17,5	240	485	20
31010D50611M05	61 G 0,5	18	292,8	529	20
31010D50651M05	65 G 0,5	18,5	312	619	20
31010D50801M05	80 G 0,5	20,1	384	752	20

CONTROL AND CONNECTION CABLES

GAALFLEX® CONTROL 500

PVC control cable (former = YSLY-JZ) 300/500 V

ELETTROTEK KABEL® GAALFLEX® CONTROL 500



Part no.	No. of cores x cross section n x mm ²	Outer-Ø ca. mm ± 10%	Copper weight kg/km	Cable weight approx. kg/km	AWG no. *)
31010D51020M07	2 x 0,75	5	14,4	47	19
31010D50031M07	3 G 0,75	5,3	21,6	59	19
31010D50041M07	4 G 0,75	6	28,8	71	19
31010D50051M07	5 G 0,75	6,6	36	84	19
31010D50071M07	7 G 0,75	7,1	50,4	110	19
31010D50081M07	8 G 0,75	7,9	57,6	136	19
31010D50091M07	9 G 0,75	8,5	64,8	152	19
31010D50101M07	10 G 0,75	8,9	72	159	19
31010D50121M07	12 G 0,75	9,5	86,4	181	19
31010D50141M07	14 G 0,75	10,3	100,8	203	19
31010D50161M07	16 G 0,75	10,7	115,2	234	19
31010D50181M07	18 G 0,75	11,1	129,6	258	19
31010D50211M07	21 G 0,75	12,6	151,2	305	19
31010D50251M07	25 G 0,75	13,3	180	354	19
31010D50301M07	30 G 0,75	14,4	216	417	19
31010D50341M07	34 G 0,75	15,2	244,8	473	19
31010D50401M07	40 G 0,75	16,2	288	546	19
31010D50421M07	42 G 0,75	16,6	302,4	565	19
31010D50501M07	50 G 0,75	18,2	360	672	19
31010D50611M07	61 G 0,75	20	439,2	803	19
31010D50651M07	65 G 0,75	20,9	468	869	19
31010D50801M07	80 G 0,75	22,2	576	1040	19
31010D51020M10	2 x 1	5,3	19,2	53	18
31010D50031M10	3 G 1	5,6	28,8	67	18
31010D50041M10	4 G 1	6,3	38,4	82	18
31010D50051M10	5 G 1	6,9	48	101	18
31010D50071M10	7 G 1	7,6	67,2	128	18
31010D50081M10	8 G 1	8,3	76,8	157	18
31010D50091M10	9 G 1	9,2	86,4	181	18
31010D50101M10	10 G 1	9,5	96	189	18
31010D50121M10	12 G 1	10	115,2	211	18
31010D50141M10	14 G 1	10,8	134,4	244	18
31010D50161M10	16 G 1	11,4	153,6	273	18
31010D50181M10	18 G 1	12,2	172,8	309	18
31010D50211M10	21 G 1	13	201,6	363	18
31010D50251M10	25 G 1	14,1	240	422	18
31010D50301M10	30 G 1	15,3	288	488	18
31010D50341M10	34 G 1	16,3	326,4	556	18
31010D50401M10	40 G 1	17,6	384	651	18
31010D50421M10	42 G 1	18,1	403,2	677	18
31010D50501M10	50 G 1	19,5	480	792	18
31010D50611M10	61 G 1	21,1	585,6	959	18
31010D50651M10	65 G 1	22,4	624	1024	18
31010D50801M10	80 G 1	24,2	768	1243	18

CONTROL AND CONNECTION CABLES

GAALFLEX® CONTROL 500

PVC control cable (former = YSLY-JZ) 300/500 V

ELETTROTEK KABEL® GAALFLEX® CONTROL 500



Part no.	No. of cores x cross section n x mm ²	Outer-Ø ca. mm ± 10%	Copper weight kg/km	Cable weight approx. kg/km	AWG no. *)
31010D51020M15	2 x 1,5	6,1	28,8	71	16
31010D50031M15	3 G 1,5	6,5	43,2	87	16
31010D50041M15	4 G 1,5	7	57,6	109	16
31010D50051M15	5 G 1,5	8	72	130	16
31010D50071M15	7 G 1,5	8,6	100,8	172	16
31010D50081M15	8 G 1,5	9,4	115,2	210	16
31010D50091M15	9 G 1,5	10,4	129,6	234	16
31010D50101M15	10 G 1,5	10,5	144	246	16
31010D50121M15	12 G 1,5	11,1	172,8	282	16
31010D50141M15	14 G 1,5	12,2	201,6	325	16
31010D50161M15	16 G 1,5	12,7	230,4	365	16
31010D50181M15	18 G 1,5	13,7	259,2	413	16
31010D50211M15	21 G 1,5	14,7	302,4	486	16
31010D50251M15	25 G 1,5	16,1	360	570	16
31010D50301M15	30 G 1,5	17,1	432	669	16
31010D50341M15	34 G 1,5	19	489,6	760	16
31010D50401M15	40 G 1,5	20,1	576	891	16
31010D50421M15	42 G 1,5	20,5	604,8	926	16
31010D50501M15	50 G 1,5	22,8	720	1089	16
31010D50611M15	61 G 1,5	24,2	878,4	1315	16
31010D50651M15	65 G 1,5	24,7	936	1419	16
31010D50801M15	80 G 1,5	27,8	1152	1709	16
31010D51020M25	2 x 2,5	7,2	48	107	14
31010D50031M25	3 G 2,5	7,9	72	133	14
31010D50041M25	4 G 2,5	8,6	96	166	14
31010D50051M25	5 G 2,5	9,5	120	205	14
31010D50071M25	7 G 2,5	10,6	168	264	14
31010D50081M25	8 G 2,5	11,7	192	327	14
31010D50091M25	9 G 2,5	12,8	216	368	14
31010D50101M25	10 G 2,5	13,6	240	384	14
31010D50121M25	12 G 2,5	14,1	288	441	14
31010D50141M25	14 G 2,5	14,9	336	508	14
31010D50161M25	16 G 2,5	15,7	384	572	14
31010D50181M25	18 G 2,5	16,9	432	641	14
31010D50211M25	21 G 2,5	18,1	504	766	14
31010D50251M25	25 G 2,5	19,8	600	888	14
31010D50031M40	3 G 4	9,3	115,2	196	12
31010D50041M40	4 G 4	10,5	153,6	247	12
31010D50051M40	5 G 4	11,4	192	305	12
31010D50071M40	7 G 4	12,8	268,8	400	12
31010D50121M40	12 G 4	16,9	461	660	12
31010D50031M60	3 G 6	10,9	172,8	286	10
31010D50041M60	4 G 6	12,1	230,4	353	10
31010D50051M60	5 G 6	13,5	288	443	10
31010D50071M60	7 G 6	14,9	403,3	580	10
31010D50041M61	4 G 10	15,5	384	600	8
31010D50051M61	5 G 10	17,3	480	750	8
31010D50071M61	7 G 10	19,0	672	981	8
31010D50041M62	4 G 16	18,8	614,4	918	6
31010D50051M62	5 G 16	20,5	768	1138	6
31010D50071M62	7 G 16	23	1075,2	1494	6
31010D50041M63	4 G 25	22,6	960	1438	4
31010D50051M63	5 G 25	25,6	1200	1803	4
31010D50071M63	7 G 25	28,2	1680	2362	4
31010D50041M64	4 G 35	26	1344	1985	2
31010D50051M64	5 G 35	29,4	1680	2483	2
31010D50071M64	7 G 35	33,3	2352	3259	2
31010D50041M65	4 G 50	32,3	1920	2714	1

Other dimensions and colours available on request.

CONTROL AND CONNECTION CABLES

GAALFLEX® CONTROL 500 CY Lean

PVC control cable with overall copper screen, 300/500 V

ELETTROTEK KABEL® GAALFLEX® CONTROL 500 CY Lean

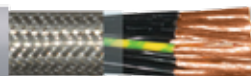

Construction:

Conductor:	flexible red copper conductor Cl.5, acc.to IEC 60228, DIN VDE 0295
Insulation:	PVC type T11
Colour cores:	black cores with consecutive numbers acc. to EN 50334, green-yellow from 3 cores
Stranding:	in layers
Wrapping:	PETP foil
Screen:	tinned copper braid
Outer sheath:	grey (RAL 7001) PVC typeTM2

Resistance:



Flame retardant and Self-extinguishing acc. to:
DIN VDE 0482 part 265-2-1
EN 50265-2-1
IEC 60332-1-2



Oil resistance acc. to:
DIN EN 50290-2-22
VDE 0819-102, TM54

Technical data:

Nominal voltage:	U ₀ /U 300/500 V
Test voltage:	3 kV acc. to DIN VDE 0281 part 2 + HD 21.1
Temperature range	
<i>Fixed laying:</i>	-40°C up to +80°C
<i>Flexible application:</i>	-5°C up to +70°C
Min. bending radius:	
<i>Fixed laying:</i>	6 x d
<i>Flexible application:</i>	20 x d

Features:

good EMC characteristics
flexible
numbered cores
on request black outer sheath
RoHS and CE approval



Part no.	No. of cores x cross section n x mm ²	Outer-Ø ca. mm ± 10%	Copper weight kg/km	Cable weight approx. kg/km	AWG no. *)
31080D50031M05	3 G 0,5	5,8	27,3	52,3	20
31080D50041M05	4 G 0,5	6,3	36,6	67,4	20
31080D50051M05	5 G 0,5	6,9	41,7	79,1	20
31080D50061M05	6 G 0,5	7,5	51,3	96,2	20
31080D50071M05	7 G 0,5	7,5	56,1	99,6	20
31080D50081M05	8 G 0,5	8,8	66,3	129,2	20
31080D50101M05	10 G 0,5	9,4	75,9	139,2	20
31080D50121M05	12 G 0,5	9,7	90,1	160,3	20
31080D50181M05	18 G 0,5	11,5	123,6	224,3	20
31080D50191M05	19 G 0,5	11,5	128,4	227,7	20
31080D50251M05	25 G 0,5	13,4	177,8	308,1	20
31080D50341M05	34 G 0,5	15,7	229,3	407,3	20
31080D50411M05	41 G 0,5	16,9	271,2	485	20
31080D50421M05	42 G 0,5	16,9	276	492	20
31080D50501M05	50 G 0,5	18,4	322,6	565,5	20
31080D50611M05	61 G 0,5	19,7	383,7	667	18

CONTROL AND CONNECTION CABLES

GAALFLEX® CONTROL 500 CY Lean

PVC control cable with overall copper screen, 300/500 V

ELETTROTEK KABEL® GAALFLEX® CONTROL 500 CY Lean

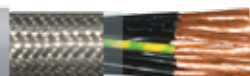

Part no.	No. of cores x cross section n x mm ²	Outer-Ø ca. mm ± 10%	Copper weight kg/km	Cable weight approx. kg/km	AWG no. *)
31080D50031M07	3 G 0,75	6,3	39	67,5	19
31080D50041M07	4 G 0,75	6,9	46,4	81,2	19
31080D50051M07	5 G 0,75	7,5	58,5	100,7	19
31080D50061M07	6 G 0,75	8,2	66,1	117,6	19
31080D50071M07	7 G 0,75	8,2	73,3	122,8	19
31080D50081M07	8 G 0,75	9,6	85,5	157,9	19
31080D50101M07	10 G 0,75	10,3	104,5	176,5	19
31080D50121M07	12 G 0,75	10,7	118,9	198,2	19
31080D50181M07	18 G 0,75	12,6	171,4	286	19
31080D50191M07	19 G 0,75	12,6	178,6	291,1	19
31080D50251M07	25 G 0,75	14,8	246,1	394,3	19
31080D50341M07	34 G 0,75	17,3	319,2	522,7	19
31080D50411M07	41 G 0,75	18,7	377,8	623,1	19
31080D50421M07	42 G 0,75	18,7	385	632,7	19
31080D50501M07	50 G 0,75	20,3	450,9	728,2	19
31080D50611M07	61 G 0,75	21,7	538,4	861,6	19
31080D51020M10	2 x 1	6,3	36,6	64,5	18
31080D50031M10	3 G 1	6,7	46,3	76,7	18
31080D50041M10	4 G 1	7,3	60,7	98,1	18
31080D50051M10	5 G 1	8	70,8	116,9	18
31080D50061M10	6 G 1	8,7	85,5	141,4	18
31080D50071M10	7 G 1	8,7	95,1	148,3	18
31080D50081M10	8 G 1	10,2	109,3	188,5	18
31080D50101M10	10 G 1	11	133,2	210,4	18
31080D50121M10	12 G 1	11,4	152,4	237,7	18
31080D50181M10	18 G 1	13,7	230,6	357,1	18
31080D50191M10	19 G 1	13,7	240,2	363,9	18
31080D50251M10	25 G 1	15,8	306,1	465,9	18
31080D50341M10	34 G 1	18,5	409	628,6	18
31080D50411M10	41 G 1	20	484,5	750,2	18
31080D50421M10	42 G 1	20	494,1	762,3	18
31080D50501M10	50 G 1	21,8	579,2	878,6	18
31080D50611M10	61 G 1	23,3	693	1041,7	18
31080D50031M15	3 G 1,5	7,4	65,6	101,1	16
31080D50041M15	4 G 1,5	8,1	80,4	123,9	16
31080D50051M15	5 G 1,5	8,9	99,9	153,8	16
31080D50061M15	6 G 1,5	9,8	118,9	185,2	16
31080D50071M15	7 G 1,5	9,8	133,3	195,4	16
31080D50081M15	8 G 1,5	11,5	152,4	247,3	16
31080D50101M15	10 G 1,5	12,4	185,8	277,3	16
31080D50121M15	12 G 1,5	12,8	214,6	315,2	16
31080D50181M15	18 G 1,5	15,4	325,3	475	16
31080D50191M15	19 G 1,5	15,4	339,7	485,2	16
31080D50251M15	25 G 1,5	17,8	442,6	631,3	16
31080D50341M15	34 G 1,5	20,9	580,5	841,8	16
31080D50411M15	41 G 1,5	22,6	689,6	1006	16
31080D50421M15	42 G 1,5	22,6	704	1023,1	16
31080D50501M15	50 G 1,5	24,9	862	1220,4	16
31080D50611M15	61 G 1,5	26,6	1033,3	1450,3	16
31080D50031M25	3 G 2,5	8,9	99,9	148,1	14
31080D50041M25	4 G 2,5	9,8	128,5	188,6	14
31080D50051M25	5 G 2,5	10,8	152,5	227,6	14
31080D50071M25	7 G 2,5	11,8	205,2	291,2	14
31080D50081M25	8 G 2,5	14,2	249,8	387,6	14
31080D50101M25	10 G 2,5	15,3	306,1	437,1	14
31080D50121M25	12 G 2,5	15,9	354,1	498,7	14
31080D50181M25	18 G 2,5	18,8	514,6	727,1	14
31080D50191M25	19 G 2,5	18,8	538,6	744,2	14
31080D50251M25	25 G 2,5	21,8	699,2	968,8	14
31080D50031M40	3 G 4	10,5	147,7	210,8	12
31080D50041M40	4 G 4	11,5	190,8	274,1	12
31080D50051M40	5 G 4	12,8	233,8	333,9	12
31080D50071M40	7 G 4	14,3	326,6	442,9	12

Other dimensions and colours available on request.

CONTROL AND CONNECTION CABLES

GAALFLEX® CONTROL 500 H

Halogen-free control cable 300/500 V



ELETTROTEK KABEL® GAALFLEX® CONTROL 500 H

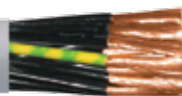

Construction:

- Conductor:** flexible red copper conductor Cl.5, acc. to IEC 60228, DIN VDE 0295
- Insulation:** halogen-free compound type TI6
- Colour cores:** black cores with consecutive numbers acc. to EN 50334, green-yellow from 3 cores
- Stranding:** in layers
- Outer sheath:** grey (RAL 7001) halogen-free compound type TM7

Resistance:



Flame retardant and Self-extinguishing acc. to:

DIN VDE 0482 part 265-2-1
EN 50265-2-1
IEC 60332-2-1 (flame spread on a single cable)
IEC 60332-3-24 respectively IEC 60332-3-25 (flame spread on vertical cable or wire bundle)



Halogen-free acc. to:

DIN VDE 0482, part 267
EN 50267-2-1
IEC 60754-1



Corrosiveness of conflagration gases acc. to:

DIN VDE 0482 part 267
EN 50267-2-2
IEC 60754-2



Low smoke density acc. to:

DIN VDE 0482 part. 268-1-2,
IEC 61034-1-2,
EN 50268-1-2

Technical data:

- Nominal voltage:** U₀/U 300/500 V
- Test voltage:** 3 kV
- Temperature range**
- Fixed laying:* -40°C up to +70°C
- Flexible application:* -15°C up to +70°C
- Min. bending radius:**
- Fixed laying:* 4 x d
- Flexible application:* 15 x d

Features:

- flexible
- RoHS and CE approval



Part no.	No. of cores x cross section n x mm ²	Outer-Ø ca. mm ± 10%	Copper weight kg/km	Cable weight approx. kg/km	AWG no. (*)
31030D51020M05	2 x 0,5	4,8	9,6	34	20
31030D50031M05	3 G 0,5	5,1	14,4	41	20
31030D50041M05	4 G 0,5	5,5	19,2	50	20
31030D50051M05	5 G 0,5	6,3	24,0	63	20
31030D50071M05	7 G 0,5	6,8	33,6	78	20
31030D50121M05	12 G 0,5	9,1	57,6	139	20
31030D50141M05	14 G 0,5	9,6	67,2	160	20
31030D50181M05	18 G 0,5	10,8	86,4	199	20
31030D50251M05	25 G 0,5	12,5	120	269	20
31030D50341M05	34 G 0,5	14,9	163,2	377	20
31030D51020M07	2 x 0,75	5,2	14,4	42	19
31030D50031M07	3 G 0,75	5,5	21,6	51	19
31030D50041M07	4 G 0,75	6,2	28,8	66	19
31030D50051M07	5 G 0,75	6,8	36,0	80	19
31030D50071M07	7 G 0,75	7,6	43,2	94	19
31030D50121M07	12 G 0,75	9,9	86,4	177	19
31030D50181M07	18 G 0,75	12	129,6	261	19
31030D50341M07	34 G 0,75	16,5	245	493	19
31030D50371M07	37 G 0,75	16,5	266,4	509	19

CONTROL AND CONNECTION CABLES

GAALFLEX® CONTROL 500 H

Halogen-free control cable 300/500 V



ELETTROTEK KABEL® GAALFLEX® CONTROL 500 H

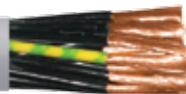

Part no.	No. of cores x cross section n x mm ²	Outer-Ø ca. mm ± 10%	Copper weight kg/km	Cable weight approx. kg/km	AWG no. *)
31030D51020M10	2 x 1	5,5	19,2	50	18
31030D50031M10	3 G 1	6,1	28,8	64	18
31030D50041M10	4 G 1	6,6	38,4	78	18
31030D50051M10	5 G 1	7,2	48	95	18
31030D50071M10	7 G 1	8	57,6	117	18
31030D50101M10	10 G 1	8	67,2	124	18
31030D50121M10	12 G 1	10,4	96	194	18
31030D50161M10	16 G 1	10,7	115,2	209	18
31030D50181M10	18 G 1	12	153,6	277	18
31030D50251M10	25 G 1	12,7	172,8	313	18
31030D50341M10	34 G 1	14,9	240	433	18
31030D50371M10	37 G 1	17,7	326,4	601	18
31030D50411M10	41 G 1	17,7	355,2	622	18
31030D51020M15	2 x 1,5	6,3	28,8	67	16
31030D50031M15	3 G 1,5	6,7	43,2	83	16
31030D50041M15	4 G 1,5	7,5	57,6	107	16
31030D50051M15	5 G 1,5	8,2	72	131	16
31030D50071M15	7G 1,5	9,1	100,8	170	16
31030D50121M15	12 G 1,5	12,1	172,8	297	16
31030D50181M15	18 G 1,5	14,4	259,2	428	16
31030D50251M15	25 G 1,5	16,8	360	590	16
31030D50341M15	34 G 1,5	20	489,6	817	16
31030D50371M15	37 G 1,5	20	532,8	848	16
31030D51020M25	2 x 2,5	7,7	48	104	14
31030D50031M25	3 G 2,5	8,2	72	130	14
31030D50041M25	4 G 2,5	9,1	96	166	14
31030D50051M25	5 G 2,5	10	120	204	14
31030D50071M25	7G 2,5	11,1	168	265	14
31030D50121M25	12 G 2,5	15	288	470	14
31030D50181M25	18 G 2,5	17,9	432	687	14
31030D50251M25	25 G 2,5	20,9	600	943	14
31030D50341M25	34 G 2,5	24,9	816	1.312	14
31030D51020M40	2 x 4	9,2	76,8	153	12
31030D50031M40	3 G 4	9,7	115,2	194	12
31030D50041M40	4 G 4	10,9	153,6	248	12
31030D50051M40	5 G 4	12,1	192	310	12
31030D50071M40	7G 4	13,4	268,8	404	12
31030D51020M60	2 x 6	10,8	115,2	220	10
31030D50031M60	3 G 6	11,5	172,8	280	10
31030D50041M60	4 G 6	12,8	230,4	358	10
31030D50051M60	5 G 6	14,3	288	448	10
31030D50071M60	7G 6	15,9	403,2	584	10
31030D50031M61	3 G 10	14,5	288	452	8
31030D50041M61	4 G 10	16,3	384	585	8
31030D50051M61	5 G 10	18,2	480	730	8
31030D50071M61	7G 10	20	672	952	8
31030D50031M62	3 G 16	17	460,8	669	6
31030D50041M62	4 G 16	19	614,4	866	6
31030D50051M62	5 G 16	21,2	768	1.079	6
31030D50071M62	7 G 16	23,6	1075,2	1.424	6
31030D50041M63	4 G 25	23,7	960	1.345	4
31030D50051M63	5 G 25	26,6	1200	1.687	4
31030D50041M64	4 G 35	26,9	1344	1.812	2
31030D50051M64	5 G 35	30,2	1680	2.270	2
31030D50041M65	4 G 50	34,2	1920	2.746	1

Other dimension and colours available on request.

CONTROL AND CONNECTION CABLES

GAALFLEX® CONTROL 500 CH Lean

Halogen-free compound control cable with overall copper screen, 300/500 V



ELETTROTEK KABEL® GAALFLEX® CONTROL 500 CH lean

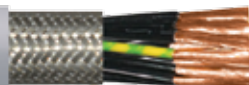

Construction:

Conductor:	flexible red copper conductor Cl.5, acc. to IEC 60228, DIN VDE 0295
Insulation:	halogen-free compound type TI6
Colour cores:	black cores with consecutive numbers acc. to EN 50334, green-yellow from 3 cores
Stranding:	in layers
Screen:	tinned copper braid
Outer sheath:	grey (RAL 7001) halogen-free compound type TM7 acc. to IEC 60092-353

Resistance:



Flame retardant and Self-extinguishing acc. to:

DIN VDE 0482 part 265-2-1
EN 50265-2-1
IEC 60332-2-1 (flame spread on a single cable)
IEC 60332-3-24 respectively IEC 60332-3-25
(flame spread on vertical cable or wire bundle)



Halogen-free acc. to

DIN VDE 0482, part 267
EN 50267-2-1
IEC 60754-1



Corrosiveness of conflagration gases acc. to:

DIN VDE 0482 part 267
EN 50267-2-2
IEC 60754-2



Low smoke density acc. to:

DIN VDE 0482 part. 268-1-2,
IEC 61034-1-2,
EN 50268-1-2

Technical data:

Nominal voltage:	U ₀ /U 300/500 V
Test voltage:	2 kV
Temperature range	
<i>Fixed laying:</i>	-40°C up to +70°C
<i>Flexible application:</i>	-15°C up to +70°C
Min. bending radius	
<i>Fixed laying:</i>	6 x d
<i>Flexible application:</i>	15 x d

Features:

good EMC critical environments.

RoHS and CE approval



CONTROL AND CONNECTION CABLES

GAALFLEX® CONTROL 500 CH Lean

Halogen-free compound control cable with overall copper screen, 300/500 V



ELETTROTEK KABEL® GAALFLEX® CONTROL 500 CH lean

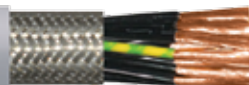

Part no.	No. of cores x cross section n x mm ²	Outer-Ø ca. mm ± 10%	Copper weight kg/km	Cable weight approx. kg/km	AWG no. *)
31090D51020M05	2 x 0,5	5,5	22,4	43,7	20
31090D50031M05	3 G 0,5	5,8	27,3	52,3	20
31090D50041M05	4 G 0,5	6,3	36,6	67,4	20
31090D50051M05	5 G 0,5	6,9	41,7	79,1	20
31090D50071M05	7 G 0,5	7,5	56,1	99,6	20
31090D50121M05	12 G 0,5	9,7	90,1	160,3	20
31090D50181M05	18 G 0,5	11,5	123,6	224,3	20
31090D50251M05	25 G 0,5	13,4	177,8	308,1	20
31090D51020M07	2 x 0,75	5,9	31,6	55,7	19
31090D50031M07	3 G 0,75	6,3	39	67,5	19
31090D50041M07	4 G 0,75	6,9	46,4	81,2	19
31090D50051M07	5 G 0,75	7,5	58,5	100,7	19
31090D50071M07	7 G 0,75	8,2	73,3	122,8	19
31090D50121M07	12 G 0,75	10,7	118,9	198,2	19
31090D50181M07	18 G 0,75	12,6	171,4	286	19
31090D50251M07	25 G 0,75	14,8	246,1	394,3	19
31090D51020M10	2 x 1	6,3	36,6	62,6	18
31090D50031M10	3 G 1	6,7	46,3	76,7	18
31090D50041M10	4 G 1	7,3	60,7	98,1	18
31090D50051M10	5 G 1	8	70,8	116,9	18
31090D50071M10	7 G 1	8,7	95,1	148,3	18
31090D50121M10	12 G 1	11,4	152,4	237,7	18
31090D50181M10	18 G 1	13,7	230,6	357,1	18
31090D50251M10	25 G 1	15,8	306,1	465,9	18
31090D51020M15	2 x 1,5	6,9	46,5	76,4	16
31090D50031M15	3 G1,5	7,4	65,6	101	16
31090D50041M15	4 G1,5	8,1	80,4	123,8	16
31090D50051M15	5 G1,5	8,9	99,9	153,6	16
31090D50121M15	12 G1,5	12,8	214,6	315	16
31090D50181M15	18 G 1,5	15,4	325,3	474,6	16
31090D50251M15	25 G 1,5	17,8	442,6	630,8	16
31090D51020M25	2x2,5	8,3	71	111,8	14
31090D50031M25	3G2,5	8,9	99,9	148,1	14
31090D50041M25	4G2,5	9,8	128,5	188,7	14
31090D50051M25	5G2,5	10,8	152,5	227,7	14
31090D50071M25	7G2,5	11,8	205,2	291,3	14
31090D50121M25	12G2,5	15,9	354,1	498,9	14
31090D50031M40	3G4	10,5	147,7	210,6	12
31090D50041M40	4G4	11,5	190,8	269,6	12
31090D50051M40	5G4	12,8	233,8	333,6	12
31090D50071M40	7G4	14,3	326,6	442,5	12
31090D50031M60	3G6	12,3	214,6	297,6	10
31090D50041M60	4G6	13,8	288,2	396	10
31090D50051M60	5G6	15,3	354,1	490,8	10
31090D50041M61	4G10	17,1	458,4	616,8	8
31090D50051M61	5G10	19,1	562,6	766,2	8
31090D50041M62	4G16	19,9	705,3	893,4	6
31090D50051M62	5G16	22,2	867,2	1111	6
31090D50041M63	4G25	24,6	1075,7	1358,5	4
31090D50041M64	4G35	27,9	1468	1803,1	2
31090D50041M65	4G50	35	2085,3	2663,6	1
31090D50041M66	4G70	40	2886,3	3579,1	2/0

Other dimension and colours available on request.

CONTROL AND CONNECTION CABLES

GAALFLEX® CONTROL 500 B

PVC control cable with coloured cores 300/500 V

ELETTROTEK KABEL® GAALFLEX® CONTROL 500 B



Construction:

Conductor:	flexible red copper conductor Cl.5, acc.to IEC 60228, DIN VDE 0295
Insulation:	special PVC compound
Colour cores:	acc. to DIN VDE 0293-308, HD 308 S2, JB/OB color code green-yellow earth-wire from 3 cores
Stranding:	in layers
Outer sheath:	grey (RAL 7001) special PVC compound

Resistance:



Flame retardant and Self-extinguishing acc. to:
DIN VDE 0482 part 265-2-1
EN 50265-2-1
IEC 60332-1-2



Oil resistance acc. to:
DIN VDE 0473 part 811-2-1
IEC EN 60811-2-1

Technical data:

Nominal voltage:	U ₀ /U 300/500 V
Test voltage:	4 kV
Temperature range	
<i>Fixed laying:</i>	-40°C up to +80°C
<i>Flexible application:</i>	-15°C up to + 80°C
Min. bending radius	
<i>Fixed laying:</i>	4 x d
<i>Flexible application:</i>	15 x d

Features:

flexible
small bending radius
on request black outer sheath
RoHS and CE approval



CONTROL AND CONNECTION CABLES

GAALFLEX® CONTROL 500 B

PVC control cable with coloured cores 300/500 V

ELETTROTEK KABEL® GAALFLEX® CONTROL 500 B



Part no.	No. of cores x cross section n x mm ²	Outer-Ø ca. mm ± 10%	Copper weight kg/km	Cable weight approx. kg/km	AWG no. *)
31020D53020M05	2 x 0,5	4,6	9,6	33	20
31020D52031M05	3 G 0,5	4,8	14,4	40	20
31020D52041M05	4 G 0,5	5,2	19,2	47	20
31020D52051M05	5 G 0,5	5,9	24	61	20
31020D52071M05	7 G 0,5	6,4	33,6	74	20
31020D53020M07	2 x 0,75	5,3	14,4	46	19
31020D52031M07	3 G 0,75	5,4	21,6	52	19
31020D52041M07	4 G 0,75	5,9	28,8	64	19
31020D52051M07	5 G 0,75	6,4	36	78	19
31020D52071M07	7 G 0,75	7,1	50,4	100	19
31020D53020M10	2 x 1	5,2	19,2	48	18
31020D52031M10	3 G 1	5,8	28,8	63	18
31020D52041M10	4 G 1	6,2	38,4	75	18
31020D52051M10	5 G 1	6,7	48	92	18
31020D52071M10	7 G 1	7,6	67,2	120	18
31020D53020M15	2 G 1,5	5,9	28,8	64	16
31020D52031M15	3 G 1,5	6,2	43,2	79	16
31020D52041M15	4 G 1,5	7,2	57,6	103	16
31020D52051M15	5 G 1,5	7,6	72	121	16
31020D52071M15	7 G 1,5	8,5	100,8	160	16
31020D53020M25	2 x 2,5	8,4	48	121	14
31020D52031M25	3 G 2,5	9	72	151	14
31020D52041M25	4 G 2,5	10,1	96	190	14
31020D52051M25	5 G 2,5	11	120	232	14
31020D52071M25	7 G 2,5	12,2	168	297	14
31020D52031M40	3 G 4	10,3	115,2	213	12
31020D52041M40	4 G 4	11,4	153,6	267	12
31020D52051M40	5 G 4	12,4	192	327	12
31020D52031M60	3 G 6	12,1	172,8	303	10
31020D52041M60	4 G 6	13,4	230,4	381	10
31020D52051M60	5 G 6	14,9	288	466	10
31020D52071M60	7 G 6	16,4	403,2	613	10
31020D52031M61	3 G 10	15	288	492	8
31020D52041M61	4 G 10	16,9	384,2	627	8
31020D52051M61	5 G 10	18,7	480	783	8
31020D52041M62	4 G 16	20	614,4	935	6
31020D52041M63	4 G 25	24,2	960	1456	4
31020D52041M64	4 G 35	27,4	1344	1978	2
31020D52041M65	4 G 50	32,9	1920	3769	1

Other dimension and colours available on request.

CONTROL AND CONNECTION CABLES

GAALFLEX® CONTROL 500 BH

Halogen-free control cable with coloured cores 300/500 V



ELETTROTEK KABEL® GAALFLEX® CONTROL 500 BH



Construction:

Conductor:	flexible red copper conductor Cl.5, acc.to IEC 60228, DIN VDE 0295
Insulation:	halogen-free compound
Colour cores:	acc. to DIN VDE 0293-308, HD 308 S2, JB/OB color code green-yellow earth-wire from 3 cores
Stranding:	in layers
Outer sheath:	grey (RAL 7001) halogen-free compound

Resistance:

	Fire performance acc.to: DIN VDE 0482 part 266-2 EN 50266-2 IEC 60332-3-24
	Flame retardant and Self-extinguishing acc. to: DIN VDE 0482 part 265-2-1 EN 50265-2-1 IEC 60332-1-2
	Halogen-free acc. to DIN VDE 0482,part 267 EN 50267-2-1 IEC 60754-1
	Corrosiveness of conflagration gases acc. to: DIN VDE 0482 part 267 EN 50267-2-2 IEC 60754-2
	Low smoke density acc. to: DIN VDE 0482 part. 268-1-2, IEC 61034-1-2, EN 50268-1-2

Technical data:

Nominal voltage:	U ₀ /U 300/500 V
Test voltage:	2 kV
Temperature range	
Fixed laying:	-40°C up to +70°C
Flexible application:	-5°C up to +70°C
Min. bending radius	
Fixed laying:	4 x d
Flexible application:	12,5 x d
Radiation resistance:	8 x 10 ⁷ cJ/kg

Features:

flexible
available with coloured cores
RoHS and CE approval



CONTROL AND CONNECTION CABLES

GAALFLEX® CONTROL 500 BH

Halogen-free control cable with coloured cores 300/500V



ELETTROTEK KABEL® GAALFLEX® CONTROL 500 BH



Part no.	No. of cores x cross section n x mm ²	Outer-Ø ca. mm ± 10%	Copper weight kg/km	Cable weight approx. kg/km	AWG no. *)
31430D53020M05	2 x 0,5	4,8	9,6	43	20
31430D52031M05	3 G 0,5	5,1	14,4	50	20
31430D52041M05	4 G 0,5	5,7	19	60	20
31430D52051M05	5 G 0,5	6,2	24	71	20
31430D53020M07	2 x 0,75	5,2	14,4	47	19
31430D52031M07	3 G 0,75	5,5	21,5	56	19
31430D52041M07	4 G 0,75	6,2	29	69	19
31430D52051M07	5 G 0,75	6,8	36	83	19
31430D53020M10	2 x 1	5,5	19,2	63	18
31430D52031M10	3 G 1	6	29	74	18
31430D52041M10	4 G 1	6,6	38,4	90	18
31430D52051M10	5 G 1	7,2	48	109	18
31430D53020M15	2 x 1,5	6,3	29	70	16
31430D52031M15	3 G 1,5	6,7	43	94	16
31430D52041M15	4 G 1,5	7,3	58	112	16
31430D52051M15	5 G 1,5	8,2	72	141	16
31430D53020M25	2 x 2,5	7,6	48	118	14
31430D52031M25	3 G 2,5	8,3	72	151	14
31430D52041M25	4 G 2,5	9,1	96	181	14
31430D52051M25	5 G 2,5	10,2	120,6	224	14
31430D53020M40	2 x 4	9,2	77	199	12
31430D52031M40	3 G 4	9,9	115	247	12
31430D52041M40	4 G 4	11	154	299	12
31430D52051M40	5 G 4	12,1	192	369	12
31430D53020M60	2 x 6	10,8	115	266	10
31430D52031M60	3 G 6	11,7	173	360	10
31430D52041M60	4 G 6	13	230	429	10
31430D52051M60	5 G 6	14,5	288	529	10
31430D53020M61	2 x 10	14	192	440	8
31430D52031M61	3 G 10	15	288	550	8
31430D52041M61	4 G 10	16,8	384	708	8
31430D52051M61	5 G 10	18,7	480	862	8
31430D53020M62	2 x 16	16,5	307	642	6
31430D52031M62	3 G 16	17,6	461	830	6
31430D52041M62	4 G 16	19,7	614	1060	6
31430D52051M62	5 G 16	21,9	768	1270	6
31430D52031M63	3 G 25	22,5	720	1190	4
31430D52041M63	4 G 25	25,2	960	1594	4
31430D52051M63	5 G 25	27,9	1200	2014	4
31430D52031M64	3 G 35	25,2	1008	1590	2
31430D52041M64	4 G 35	28	1344	2200	2
31430D52051M64	5 G 35	31	1680	2693	2
31430D52031M65	3 G 50	29,5	1440	2571	1
31430D52041M65	4 G 50	33,4	1920	3087	1
31430D52051M65	5 G 50	37,2	2400	3980	1
31430D52031M66	3 G 70	37	2016	3207	2/0
31430D52041M66	4 G 70	41,2	2688	4077	2/0
31430D52051M66	5 G 70	46	3360	5501	2/0
31430D52031M67	3 G 95	41	2736	4708	3/0
31430D52041M67	4 G 95	46	3648	5590	3/0
31430D52051M67	5 G 95	50,5	4560	6972	3/0
31430D52031M68	3 G 120	45,7	3456	5515	4/0
31430D52041M68	4 G 120	50,3	4608	7100	4/0

Other dimension and colours available on request.

GAALFLEX® CONTROL 50I (H05VV5-F)

PVC control cable with numbered cores, 300/500 V

HAR

ELETTROTEK KABEL® GAALFLEX® CONTROL 50I

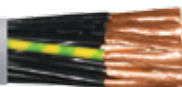

Construction:

Conductor:	flexible red copper conductor Cl.5, acc. to IEC 60228, DIN VDE 0295
Insulation:	PVC type Tl2
Colour cores:	black cores with consecutive numbers acc. to EN 50334, green-yellow from 3 cores
Stranding:	in layers
Outer sheath:	grey (RAL 7001), PVC type TM5

Resistance:



Flame retardant and Self-extinguishing acc. to:
DIN VDE 0482 part 265-2-1
EN 50265-2-1
IEC 60332-1-2



Oil resistance acc. to:
DIN VDE 0473 part 811-2-1
IEC EN 60811-2-1 TM5
DIN VDE 0281 part 1 + HD 21.1

Technical data:

Nominal voltage:	U ₀ /U 300/500 V
Test voltage:	2 kV
Temperature range	
<i>Fixed laying:</i>	-40°C up to +60°C
<i>Flexible installation:</i>	+5°C up to +60°C
<i>Temp. on conductor:</i>	+60°C
<i>Temp. on short circuit:</i>	+150°C
Min. bending radius	
<i>Fixed laying:</i>	4 x d
<i>Flexible application:</i>	6 x d

Features:

flexible
indoor use
according to DIN VDE 0281-13
RoHS and CE approval



CONTROL AND CONNECTION CABLES

GAALFLEX® CONTROL 50I (H05VV5-F)

PVC control cable with numbered cores, 300/500 V

HAR

ELETTROTEK KABEL® GAALFLEX® CONTROL 50I



Part no.	No. of cores x cross section n x mm ²	Outer-Ø ca. mm ± 10%	Copper weight kg/km	Cable weight approx. kg/km	AWG no. *)
31720D51020M05	2 X 0,5	5,9	9,6	46	20
31720D50031M05	3 G 0,5	6,3	14,4	53	20
31720D50041M05	4 G 0,5	7,1	19,2	65	20
31720D50051M05	5 G 0,5	9,4	24	80	20
31720D50071M05	7 G 0,5	8,7	33,6	116	20
31720D50121M05	12 G 0,5	11,7	57,6	170	20
31720D50181M05	18 G 0,5	13,8	86,4	248	20
31720D50251M05	25 G 0,5	16,6	120	353	20
31720D50271M05	27 G 0,5	16,9	130	399	20
31720D50341M05	34 G 0,5	19,2	163	482	20
31720D50411M05	41 G 0,5	21	197	588	20
31720D50041M07	4 G 0,75	7,5	28,8	78	19
31720D50051M07	5 G 0,75	8,4	36	98	19
31720D50071M07	7 G 0,75	10,2	50,4	146	19
31720D50121M07	12 G 0,75	12,4	86,4	212	19
31720D50181M07	18 G 0,75	14,8	130	311	19
31720D50251M07	25 G 0,75	17,7	180	427	19
31720D50271M07	27 G 0,75	18,1	194	462	19
31720D50341M07	34 G 0,75	20,5	245	588	19
31720D50411M07	41 G 0,75	22,4	295	711	19
31720D50501M07	50 G 0,75	24,6	360	859	19
31720D50611M07	61 G 0,75	26,3	439	1030	19
31720D51020M10	2 X 1	6,8	19,2	63	18
31720D50031M10	3 G 1	7,2	28,8	77	18
31720D50041M10	4 G 1	7,8	38,4	94	18
31720D50051M10	5 G 1	8,8	48	120	18
31720D50071M10	7 G 1	10,7	67,2	173	18
31720D50121M10	12 G 1	13,2	115	258	18
31720D50181M10	18 G 1	15,6	173	370	18
31720D50251M10	25 G 1	18,8	240	518	18
31720D50271M10	27 G 1	19	259	558	18
31720D50341M10	34 G 1	21,8	326	708	18
31720D50411M10	41 G 1	23,6	392	846	18
31720D50611M10	61 G 1	27,9	586	1265	18
31720D51020M15	2 X 1,5	7,7	28,8	84	16
31720D50031M15	3 G 1,5	8,4	43,2	106	16
31720D50041M15	4 G 1,5	9,2	57,6	131	16
31720D50051M15	5 G 1,5	10,3	72	165	16
31720D50071M15	7 G 1,5	12,7	101	247	16
31720D50121M15	12 G 1,5	15,4	173	362	16
31720D50181M15	18 G 1,5	18,4	259	530	16
31720D50251M15	25 G 1,5	22,1	360	724	16
31720D50271M15	27 G 1,5	22,6	389	792	16
31720D50341M15	34 G 1,5	25,7	490	1018	16
31720D50411M15	41 G 1,5	28,1	590	1272	16
31720D50611M15	61 G 1,5	32,7	878	1889	16
31720D51020M25	2 X 2,5	9,5	48	123	14
31720D50031M25	3 G 2,5	10,3	72	155	14
31720D50041M25	4 G 2,5	11,3	96	197	14
31720D50051M25	5 G 2,5	12,5	120	242	14
31720D50071M25	7 G 2,5	15,2	168	365	14
31720D50121M25	12 G 2,5	18,7	288	541	14
31720D50181M25	18 G 2,5	22,5	432	798	14
31720D50251M25	25 G 2,5	26,9	600	1103	14
31720D50271M25	27 G 2,5	27,5	648	1203	14
31720D50341M25	34 G 2,5	31,2	816	1571	14
31720D50501M25	50 G 2,5	37,5	1200	2252	14

Other dimension and colours available on request.

GAALFLEX® CONTROL 501 CY (H05VVC4V5-K)

PVC control cable with numbered cores, inner sheath and overall copper screen, 300/500 V

HAR

ELETTROTEK KABEL® GAALFLEX® CONTROL 501 CY

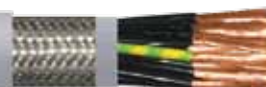

Construction:

Conductor:	flexible red copper conductor Cl.5, acc.to IEC 60228, DIN VDE 0295
Insulation:	PVC type Tl2
Colour cores:	black cores with consecutive numbers acc. to EN 50334, green-yellow from 3 cores
Stranding:	in layers
Inner sheath:	grey (RAL 7001), PVC type TM5
Screen:	tinned copper braid
Outer sheath:	grey (RAL 7001) PVC type TM5

Resistance:



Flame retardant and Self-extinguishing acc. to:
DIN VDE 0482 part 265-2-1
EN 50265-2-1
IEC 60332-1-2



Oil resistance acc. to:
DIN VDE 0473 part 811-2-1
IEC EN 60811-2-1 TM5
DIN VDE 0281 part 1 + HD 21.1

Technical data:

Nominal voltage:	U ₀ /U 300/500 V
Test voltage:	2 kV
Temperature range	
<i>Fixed laying:</i>	-40°C up to +60°C
<i>Flexible installation:</i>	+5°C up to +60°C
<i>Temp. on conductor:</i>	+60°C
<i>Temp. on short circuit:</i>	+150°C
Min. bending radius	8 x d

Features:

flexible
good EMC characteristics
indoor use
RoHS and CE approval



CONTROL AND CONNECTION CABLES

GAALFLEX® CONTROL 501 CY (H05VVC4V5-K)

PVC control cable with numbered cores, inner sheath and overall copper screen, 300/500 V

HAR

ELETTROTEK KABEL® GAALFLEX® CONTROL 501 CY

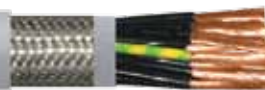

Part no.	No. of cores x cross section n x mm ²	Outer-Ø ca. mm ± 10%	Copper weight kg/km	Cable weight approx. kg/km	AWG no. *)
31570D51020M05	2 X 0,5	8,7	30	92	20
31570D50031M05	3 G 0,5	9	36	109	20
31570D50041M05	4 G 0,5	9,6	58	126	20
31570D50051M05	5 G 0,5	10,5	63	156	20
31570D50061M05	6 G 0,5	10,7	67	176	20
31570D50171M05	7 G 0,5	12,2	70	192	20
31570D50121M05	12 G 0,5	14,9	105	280	20
31570D50181M05	18 G 0,5	16,9	137	405	20
31570D50251M05	25 G 0,5	19,7	210	532	20
31570D50341M05	34 G 0,5	22,5	298	634	20
31570D50501M05	50 G 0,5	25,8	470	970	20
31570D50601M05	60 G 0,5	28,3	530	1173	20
31570D51020M07	2 X 0,75	9	46	102	19
31570D50031M07	3 G 0,75	9,3	48	130	19
31570D50041M07	4 G 0,75	10,1	55	164	19
31570D50051M07	5 G 0,75	10,9	66	189	19
31570D50071M07	7 G 0,75	12,9	85	247	19
31570D50121M07	12 G 0,75	15,6	135	327	19
31570D50181M07	18 G 0,75	18,1	190	470	19
31570D50251M07	25 G 0,75	20,9	275	643	19
31570D50341M07	34 G 0,75	23,8	340	821	19
31570D50501M07	50 G 0,75	28,2	582	1160	19
31570D50611M07	61 G 0,75	30	679	1402	19
31570D51020M10	2 X 1	9,2	48	114	18
31570D50031M10	3 G 1	9,9	59	143	18
31570D50041M10	4 G 1	10,6	70	175	18
31570D50051M10	5 G 1	11,6	84	205	18
31570D50071M10	7 G 1	13,8	106	264	18
31570D50121M10	12 G 1	16,4	174	420	18
31570D50181M10	18 G 1	18,9	240	561	18
31570D50251M10	25 G 1	22	332	792	18
31570D50341M10	34 G 1	25,1	420	996	18
31570D50411M10	41 G 1	26	578	1155	18
31570D50501M10	50 G 1	29,9	728	1300	18
31570D50611M10	61 G 1	31,8	883	1500	18
31570D51020M15	2 X 1,5	10,5	69	146	16
31570D50031M15	3 G 1,5	10,9	75	176	16
31570D50041M15	4 G 1,5	12	90	207	16
31570D50051M15	5 G 1,5	13,3	108	268	16
31570D50121M15	7 G 1,5	15,6	157	418	16
31570D50181M15	12 G 1,5	18,6	240	500	16
31570D50251M15	18 G 1,5	21,9	355	707	16
31570D50271M15	25 G 1,5	25,5	448	950	16
31570D50341M15	34 G 1,5	29,5	754	1204	16
31570D50411M15	41 G 1,5	30,2	805	1453	16
31570D50501M15	50 G 1,5	34,8	1033	1663	16
31570D50611M15	61 G 1,5	37	1238	1852	16
31570D51020M25	2 X 2,5	12	81	190	14
31570D50031M25	3 G 2,5	12,7	104	240	14
31570D50041M25	4 G 2,5	14,6	163	323	14
31570D50051M25	5 G 2,5	15,6	175	364	14
31570D50071M25	7 G 2,5	18,4	235	439	14
31570D50121M25	12 G 2,5	22,2	375	744	14
31570D50181M25	18 G 2,5	26	522	1052	14
31570D50251M15	25 G 2,5	29,4	897	1375	14
31570D50341M15	34 G 2,5	33,3	1179	1892	14

Other dimension and colours available on request.

CONTROL AND CONNECTION CABLES

GAALFLEX® CONTROL 500 FL OR

PVC control cable, acc. to CEI 20-22/2 comparable to (as far applicable) IEC 60332-3A , 450/750V

ELETTROTEK KABEL® GAALFLEX® CONTROL 500 FL OR



Construction:

- Conductor:** flexible red copper conductor Cl.5, acc.to CEI 20-29, DIN VDE 0295
- Insulation:** PVC type T11, acc. to CEI 20-11, VDE 0207
- Colour cores:** black cores with consecutive numbers acc. to EN 50334, green-yellow from 3 cores
- Stranding:** in layers
- Outer sheath:** grey (RAL 7001) PVC type TM2, acc. to CEI 20-11, VDE 0207

Resistance:



Flame retardant and Self-extinguishing acc. to:
CEI 20-22/1
CEI 20-22/2 comparable to (as far applicable)
IEC 60332-3A
CEI 20-22/4 IV° Ed. 1996



Corrosiveness of conflagration gases acc. to:
CEI 20-37/2 II° Ed. 1997
comparable to (as far applicable)
EN 50267-2
IEC 60754-2



Oil resistance acc. to:
CEI 20-34/2-1
CEI EN 60811-2-1

Technical data:

- Nominal voltage:** U₀/U 450/750 V
- Test voltage:** 4 kV
- Temperature range**
- Fixed laying:* -40°C up to +80°C
- Flexible application:* -5°C up to +70°C
- Min. bending radius:**
- Fixed laying:* 4 x d
- Flexible installation:* 15 x d

Features:

- acc. to CEI 20-11, CEI 20-20/1, CEI 20-20 IV° Ed. 1996
- flexible
- numbered cores
- small bending radius
- on request black outer sheath
- RoHS and CE approval



Part no.	No. of cores x cross section n x mm ²	Outer-Ø ca.mm ± 10%	Copper weight kg/km	Cable weight approx. kg/km	AWG no.®)
31450E51020M05	2 x 0,5	4,8	9,6	34	20
31450E50031M05	3 G 0,5	5,1	14,4	41	20
31450E50041M05	4 G 0,5	5,5	19,2	49	20
31450E50051M05	5 G 0,5	6,3	24	64	20
31450E50061M05	6 G 0,5	6,8	28,8	75	20
31450E50071M05	7 G 0,5	6,8	33,6	78	20
31450E50081M05	8 G 0,5	8,1	38,4	105	20
31450E50091M05	9 G 0,5	8,5	43,2	116	20
31450E50101M05	10 G 0,5	8,6	48	121	20
31450E50121M05	12 G 0,5	9,1	57,6	139	20
31450E50141M05	14 G 0,5	9,5	67,2	154	20
31450E50161M05	16 G 0,5	10	76,8	172	20
31450E50181M05	18 G 0,5	10,8	86,4	199	20
31450E50191M05	19 G 0,5	10,8	91,2	202	20
31450E50241M05	24 G 0,5	12,5	115,2	266	20
31450E50251M05	25 G 0,5	12,5	120	270	20
31450E50341M05	34 G 0,5	14,9	163,2	378	20
31450E50371M05	37 G 0,5	14,9	177,6	388	20
31450E50421M05	42 G 0,5	15,9	201,6	441	20
31450E50501M05	50 G 0,5	17,6	240	536	20
31450E50561M05	56 G 0,5	18,4	268,8	590	20
31450E50611M05	61 G 0,5	18,7	292,8	620	20

CONTROL AND CONNECTION CABLES

GAALFLEX® CONTROL 500 FL OR

PVC control cable, acc. to CEI 20-22/2 comparable to (as far applicable) IEC 60332-3A , 450/750 V

ELETTROTEK KABEL® GAALFLEX® CONTROL 500 FL OR

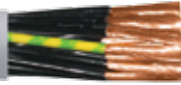

Part no.	No. of cores x cross section n x mm ²	Outer-Ø ca. mm ± 10%	Copper weight kg/km	Cable weight approx. kg/km	AWG no. *)
31450E51020M07	2 x 0,75	5,2	14,4	42	19
31450E50031M07	3 G 0,75	5,5	21,6	51	19
31450E50041M07	4 G 0,75	6,2	28,8	66	19
31450E50051M07	5 G 0,75	6,8	36	80	19
31450E50061M07	6 G 0,75	7,6	43,2	99	19
31450E50071M07	7 G 0,75	7,6	50,4	104	19
31450E50081M07	8 G 0,75	9	57,6	136	19
31450E50091M07	9 G 0,75	9,4	64,8	150	19
31450E50101M07	10 G 0,75	9,6	72	160	19
31450E50121M07	12 G 0,75	9,9	86,4	177	19
31450E50141M07	14 G 0,75	10,6	100,8	204	19
31450E50161M07	16 G 0,75	11,1	115,2	227	19
31450E50181M07	18 G 0,75	12	129,6	262	19
31450E50191M07	19 G 0,75	12	136,8	267	19
31450E50241M07	24 G 0,75	13,8	172,8	347	19
31450E50251M07	25 G 0,75	13,9	180	356	19
31450E50341M07	34 G 0,75	16,5	244,8	495	19
31450E50371M07	37 G 0,75	16,5	266,4	510	19
31450E50421M07	42 G 0,75	17,8	302,4	589	19
31450E50501M07	50 G 0,75	19,4	360	700	19
31450E50561M07	56 G 0,75	20,6	403,2	787	19
31450E50611M07	61 G 0,75	20,9	439,2	827	19
31450E51020M10	2 x 1	5,5	19,2	49	18
31450E50031M10	3 G 1	6,1	28,8	64	18
31450E50041M10	4 G 1	6,6	38,4	79	18
31450E50051M10	5 G 1	7,2	48,0	95	18
31450E50061M10	6 G 1	8	57,6	116	18
31450E50071M10	7 G 1	8	67,2	123	18
31450E50081M10	8 G 1	9,5	76,8	161	18
31450E50091M10	9 G 1	10	86,4	179	18
31450E50101M10	10 G 1	10,4	96	196	18
31450E50121M10	12 G 1	10,7	115,2	217	18
31450E50141M10	14 G 1	11,2	134,4	244	18
31450E50161M10	16 G 1	12	153,6	279	18
31450E50181M10	18 G 1	12,7	172,8	313	18
31450E50191M10	19 G 1	12,7	182,4	320	18
31450E50241M10	24 G 1	14,9	230,4	426	18
31450E50251M10	25 G 1	14,9	240	432	18
31450E50341M10	34 G 1	17,7	326,4	602	18
31450E50371M10	37 G 1	17,7	355,2	622	18
31450E50421M10	42 G 1	19,2	403,2	721	18
31450E50501M10	50 G 1	20,9	480	856	18
31450E50561M10	56 G 1	22,1	537,6	958	18
31450E50611M10	61 G 1	22,4	585,6	1008	18
31450E51020M15	2 x 1,5	6,3	28,8	68	16
31450E50031M15	3 G 1,5	6,7	43,2	84	16
31450E50041M15	4 G 1,5	7,5	57,6	108	16
31450E50051M15	5 G 1,5	8,2	72	131	16
31450E50061M15	6 G 1,5	9,1	86,4	160	16
31450E50071M15	7 G 1,5	9,1	100,8	171	16
31450E50081M15	8 G 1,5	10,8	115,2	221	16
31450E50091M15	9 G 1,5	11,3	129,6	245	16
31450E50101M15	10 G 1,5	11,8	144	269	16
31450E50121M15	12 G 1,5	12,1	172,8	298	16
31450E50141M15	14 G 1,5	12,7	201,6	336	16
31450E50161M15	16 G 1,5	13,6	230,4	385	16
31450E50181M15	18 G 1,5	14,4	259,2	433	16
31450E50191M15	19 G 1,5	14,4	273,6	443	16
31450E50241M15	24 G 1,5	16,8	345,6	583	16
31450E50251M15	25 G 1,5	16,8	360	594	16
31450E50341M15	34 G 1,5	20	489,6	827	16
31450E50371M15	37 G 1,5	20	532,8	858	16
31450E50421M15	42 G 1,5	21,6	604,8	989	16
31450E50501M15	50 G 1,5	23,8	720	1190	16
31450E50561M15	56 G 1,5	25,1	806,4	1328	16
31450E50611M15	61 G 1,5	25,4	878,4	1398	16

CONTROL AND CONNECTION CABLES

GAALFLEX® CONTROL 500 FL OR

PVC control cable, acc. to CEI 20-22/2 comparable to (as far applicable) IEC 60332-3A , 450/750V

ELETTROTEK KABEL® GAALFLEX® CONTROL 500 FL OR



Part no.	No. of cores x cross section n x mm ²	Outer-Ø ca. mm ± 10%	Copper weight kg/km	Cable weight approx. kg/km	AWG no. *)
31450E51020M25	2 x 2,5	7,7	48	105	14
31450E50031M25	3 G 2,5	8,2	72	132	14
31450E50041M25	4 G 2,5	9,1	96	167	14
31450E50051M25	5 G 2,5	10	120	205	14
31450E50071M25	7 G 2,5	11,1	168	268	14
31450E50081M25	8 G 2,5	13,3	192	348	14
31450E50101M25	10 G 2,5	14,3	240	416	14
31450E50121M25	12 G 2,5	15	288	475	14
31450E50141M25	14 G 2,5	15,7	336	535	14
31450E50161M25	16 G 2,5	16,7	384	608	14
31450E50181M25	18 G 2,5	17,9	432	692	14
31450E50251M25	25 G 2,5	20,9	600	952	14
31450E50341M25	34 G 2,5	24,9	816	1325	14
31450E51020M40	2 x 4	9,2	76,8	155	12
31450E50031M40	3 G 4	9,7	115,2	194	12
31450E50041M40	4 G 4	10,9	153,6	251	12
31450E50051M40	5 G 4	12,1	192	312	12
31450E50071M40	7 G 4	13,4	268,8	407	12
31450E51020M60	2 x 6	10,8	115,2	221	10
31450E50031M60	3 G 6	11,5	172,8	281	10
31450E50041M60	4 G 6	12,8	230,4	360	10
31450E50051M60	5 G 6	14,3	288	450	10
31450E50071M60	7 G 6	15,9	403,2	591	10
31450E50031M61	3 G 10	14,7	288	463	8
31450E50041M61	4 G 10	16,3	384	591	8
31450E50051M61	5 G 10	18,2	480	738	8
31450E50071M61	7 G 10	20	672	958	8
31450E50031M62	3 G 16	17	460,8	363	6
31450E50041M62	4 G 16	18,8	614,4	864	6
31450E50051M62	5 G 16	21,2	768	1089	6
31450E50071M62	7 G 16	23,6	1075,2	1439	6
31450E50041M63	4 G 25	23,7	960,0	1359	4
31450E50051M63	5 G 25	26,6	1200	1705	4
31450E50071M63	7 G 25	29,5	1680	2246	4
31450E50041M64	4 G 35	26,9	1344	1826	2
31450E50051M64	5 G 35	30,2	1680	2291	2
31450E50031M65	3 G 50	31,1	1440	2181	1
31450E50041M65	4 G 50	34,2	1920	2767	1
31450E50041M66	4 G 70	39,2	2688	3733	2/0

Other dimensions and colours available on request.

CONTROL AND CONNECTION CABLES

GAALFLEX® CONTROL 500 CY FL OR

PVC control cable with overall copper screen, acc. to CEI 20-22/2 comparable to (as far applicable) IEC 60332-3A, 450/750 V

ELETTROTEK KABEL® GAALFLEX® CONTROL 500 CY FL OR

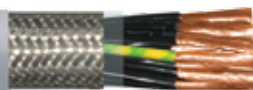

Construction:

Conductor:	flexible red copper conductor Cl.5, acc.to CEI 20-29, DIN VDE 0295
Insulation:	PVC type T11, acc. to CEI 20-11, VDE 0207
Colour cores:	black cores with consecutive numbers acc. to EN 50334, green-yellow from 3 cores
Stranding:	in layers
Wrapping:	PETP foil
Screen:	tinned copper braid
Outer sheath:	grey (RAL 7001) PVC type TM2, acc. to CEI 20-11, VDE 0207

Resistance:



Flame retardant and Self-extinguishing acc. to:
CEI 20-22/1
CEI 20-22/2 comparable to (as far applicable)
IEC 60332-3A
CEI 20-22/4 IV° Ed. 1996



Corrosiveness of conflagration gases acc. to:
CEI 20-37/2 II° Ed. 1997
comparable to (as far applicable)
EN 50267-2
IEC 60754-2



Oil resistance acc. to:
CEI 20-34/2-1
CEI EN 60811-2-1

Technical data:

Nominal voltage:	Uo/U 450/750 V
Test voltage:	4 kV
Temperature range	
<i>Fixed laying:</i>	-40°C up to +80°C
<i>Flexible application:</i>	-5°C up to +70°C
Min. bending radius:	
<i>Fixed laying:</i>	6 x d
<i>Flexible installation:</i>	20 x d

Features:

acc. to CEI 20-11, CEI 20-20/1, CEI 20-20 IV° Ed. 1996
flexible
numbered cores
small bending radius
on request black outer sheath
RoHS and CE approval



Part no.	No. of cores x cross section n x mm ²	Outer-Ø ca. mm ± 10%	Copper weight kg/km	Cable weight approx. kg/km	AWG no.*)
31460E51020M05	2 x 0,5	5,4	22,4	43	20
31460E50031M05	3 G 0,5	5,7	27,3	51	20
31460E50041M05	4 G 0,5	6,3	36,6	68	20
31460E50051M05	5 G 0,5	6,9	41,7	79	20
31460E50071M05	7 G 0,5	7,6	56	101	20
31460E50121M05	12 G 0,5	9,7	90,1	159	20
31460E50141M05	14 G 0,5	10,1	99,8	176	20
31460E50161M05	16 G 0,5	10,8	109,2	198	20
31460E50181M05	18 G 0,5	11,4	123,6	222	20
31460E50251M05	25 G 0,5	13,5	178,1	310	20
31460E50341M05	34 G 0,5	15,7	229,3	405	20
31460E51020M07	2 x 0,75	6	27,3	52	19
31460E50031M07	3 G 0,75	6,3	39	68	19
31460E50041M07	4 G 0,75	6,8	46,3	80	19
31460E50051M07	5 G 0,75	7,6	58,4	102	19
31460E50071M07	7 G 0,75	8,2	73,3	122	19
31460E50121M07	12 G 0,75	10,7	119	199	19
31460E50141M07	14 G 0,75	11,2	137,8	226	19
31460E50161M07	16 G 0,75	11,9	152,3	255	19
31460E50181M07	18 G 0,75	12,6	171,3	285	19
31460E50251M07	25 G 0,75	14,9	246	397	19
31460E50341M07	34 G 0,75	17,3	319	519	19
31460E50371M07	37 G 0,75	17,3	340,6	544	19
31460E50421M07	42 G 0,75	18,6	385,1	630	19
31460E50501M07	50 G 0,75	20,2	450,8	723	19
31460E50611M07	61 G 0,75	21,7	538,3	857	19

CONTROL AND CONNECTION CABLES

GAALFLEX® CONTROL 500 CY FL OR

PVC control cable with overall copper screen, acc. to CEI 20-22/2 comparable to (as far applicable) IEC 60332-3A, 450/750 V

ELETTROTEK KABEL® GAALFLEX® CONTROL 500 CY FL OR

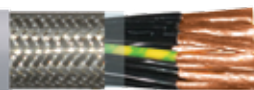

Part no.	No. of cores x cross section n x mm ²	Outer-Ø ca. mm ± 10%	Copper weight kg/km	Cable weight approx. kg/km	AWG no. *)
31460E51020M10	2 x 1	6,3	36,6	63	18
31460E50031M10	3 G 1	6,7	46,3	77	18
31460E50041M10	4 G 1	7,2	60,8	97	18
31460E50051M10	5 G 1	8,0	70,9	117	18
31460E50071M10	7 G 1	8,6	95	146	18
31460E50121M10	12 G 1	11,3	152,6	236	18
31460E50141M10	14 G 1	12,0	171,5	269	18
31460E50161M10	16 G 1	12,6	195,3	303	18
31460E50181M10	18 G 1	13,7	230,4	357	18
31460E50251M10	25 G 1	15,7	306,1	464	18
31460E50341M10	34 G 1	18,5	409,1	627	18
31460E50371M10	37 G 1	18,5	437,9	658	18
31460E50421M10	42 G 1	20,0	494,2	761	18
31460E50501M10	50 G 1	21,7	579,1	873	18
31460E50611M10	61 G 1	23,4	692,8	1046	18
31460E51020M15	2 x 1,5	6,9	46,5	76	16
31460E50031M15	3 G 1,5	7,5	65,6	103	16
31460E50041M15	4 G 1,5	8,1	80,5	125	16
31460E50051M15	5 G 1,5	9,0	99,9	156	16
31460E50071M15	7 G 1,5	9,7	133,3	195	16
31460E50121M15	12 G 1,5	12,7	214,5	315	16
31460E50141M15	14 G 1,5	13,7	259,2	378	16
31460E50161M15	16 G 1,5	14,4	296,6	428	16
31460E50181M15	18 G 1,5	15,4	325,3	478	16
31460E50251M15	25 G 1,5	17,8	434,1	630	16
31460E50341M15	34 G 1,5	21,0	580,5	850	16
31460E50371M15	37 G 1,5	21,0	623,7	895	16
31460E50421M15	42 G 1,5	22,6	704,3	1032	16
31460E50501M15	50 G 1,5	25,0	861,8	1235	16
31460E50611M15	61 G 1,5	26,6	1033,5	1464	16
31460E51020M25	2 x 2,5	8,3	71,2	112	14
31460E50031M25	3 G 2,5	9,0	99,9	151	14
31460E50041M25	4 G 2,5	9,7	128,5	189	14
31460E50051M25	5 G 2,5	10,8	152,4	230	14
31460E50071M25	7 G 2,5	11,9	205,1	296	14
31460E50121M25	12 G 2,5	15,8	354,1	500	14
31460E50141M25	14 G 2,5	16,7	410,7	579	14
31460E50161M25	16 G 2,5	17,7	458,3	653	14
31460E50181M25	18 G 2,5	18,7	514,5	730	14
31460E50251M25	25 G 2,5	21,7	699,1	973	14
31460E50341M25	34 G 2,5	25,9	958	1346	14
31460E51020M40	2 x 4	9,8	109,5	163	12
31460E50031M40	3 G 4	10,5	147,6	213	12
31460E50041M40	4 G 4	11,5	190,6	269	12
31460E50051M40	5 G 4	12,7	233,7	334	12
31460E51020M60	2 x 6	11,4	152,4	221	10
31460E50031M60	3 G 6	12,3	214,5	300	10
31460E50041M60	4 G 6	13,8	288,4	399	10
31460E50051M60	5 G 6	15,3	354,1	494	10
31460E51020M61	3 G 10	15,5	353,9	480	8
31460E50031M61	4 G 10	17,1	458,4	619	8
31460E50041M61	5 G 10	19,2	562,7	776	8
31460E51020M62	3 G 16	18,0	543,4	698	6
31460E50031M62	4 G 16	19,8	705,2	900	6
31460E50041M62	5 G 16	22,2	867,1	1125	6

Other dimensions and colours available on request.

CONTROL AND CONNECTION CABLES

GAALFLEX® CONTROL 500 SY (TR)

transparent PVC control cables, inner sheath and steel wire braid armouring, 300/500 V



Construction:

Conductor:	flexible red copper conductor Cl.5, acc.to IEC 60228, DIN VDE 0295
Insulation:	PVC type T11
Colour cores:	black cores with consecutive numbers acc. to EN 50334, green-yellow from 3 cores
Stranding:	in layers
Inner sheath:	PVC type TM2
Armouring::	braid of galvanized steel wires
Outer sheath:	transparent, PVC type TM2

Resistance:



Flame retardant and Self-extinguishing acc. to:
DIN VDE 0482 part 265-2-1
EN 50265-2-1
IEC 60332-1-2



Oil resistance:
DIN VDE 0473 part 811-2-1
IEC EN 60811-2-1

Technical data:

Nominal voltage:	U ₀ /U 300/500 V
Test voltage:	3 kV
Temperature range	
<i>Fixed laying:</i>	-40°C up to +80°C
<i>Flexible installation:</i>	-5°C up to +70°C
Min. bending radius	
<i>Fixed laying:</i>	6 x d
<i>Flexible installation:</i>	20 x d

Features:

high mechanical loading capacity

flexible

RoHS and CE approval



Part no.	No.of cores x cross section n x mm ²	Outer-Ø ca.mm ± 10%	Copper weight kg/km	Cable weight approx. kg/km	AWG no.*)
31110DT1020M05	2 x 0,5	7,2	9,6	74	20
31110DT0031M05	3 G 0,5	7,5	14,4	82	20
31110DT0041M05	4 G 0,5	7,9	19,2	92	20
31110DT0051M05	5 G 0,5	8,7	24	110	20
31110DT0071M05	7 G 0,5	9,2	33,6	136	20
31110DT0121M05	12 G 0,5	11,5	57,6	205	20
31110DT0181M05	18 G 0,5	13,6	86,4	294	20
31110DT0251M05	25 G 0,5	15,3	120	387	20
31110DT0341M05	34 G 0,5	17,7	163,2	505	20
31110DT0371M05	37 G 0,5	17,7	177,6	515	20
31110DT0421M05	42 G 0,5	18,9	201,6	596	20
31110DT0501M05	50 G 0,5	20,6	240	699	20
31110DT0611M05	61 G 0,5	21,4	292,8	774	20

CONTROL AND CONNECTION CABLES

GAALFLEX® CONTROL 500 SY (TR)

transparent PVC control cables, inner sheath and steel wire braid armouring, 300/500 V



Part no.	No. of cores x cross section n x mm ²	Outer-Ø ca. mm ± 10%	Copper weight kg/km	Cable weight approx. kg/km	AWG no. *)
31110DT1020M07	2 x 0,75	7,6	14,4	84	19
31110DT0031M07	3 G 0,75	7,9	21,6	94	19
31110DT0041M07	4 G 0,75	8,6	28,8	112	19
31110DT0051M07	5 G 0,75	9,2	36	138	19
31110DT0071M07	7 G 0,75	10	50,4	165	19
31110DT0121M07	12 G 0,75	12,5	86,4	261	19
31110DT0181M07	18 G 0,75	14,8	129,6	377	19
31110DT0251M07	25 G 0,75	16,7	180	479	19
31110DT0341M07	34 G 0,75	19,5	244,8	653	19
31110DT0371M07	37 G 0,75	19,5	266,4	668	19
31110DT0421M07	42 G 0,75	20,8	302,4	753	19
31110DT0501M07	50 G 0,75	22,4	360	871	19
31110DT0611M07	61 G 0,75	23,6	439,2	1060	19
31110DT1020M10	2 x 1	7,9	19,2	92	18
31110DT0031M10	3 G 1	8,5	28,8	110	18
31110DT0041M10	4 G 1	9	38,4	136	18
31110DT0051M10	5 G 1	9,6	48	154	18
31110DT0071M10	7 G 1	10,4	67,2	185	18
31110DT0121M10	12 G 1	13,5	115,2	312	18
31110DT0181M10	18 G 1	15,5	172,8	431	18
31110DT0251M10	25 G 1	17,7	240	560	18
31110DT0341M10	34 G 1	20,7	326,4	765	18
31110DT0371M10	37 G 1	20,7	355,2	785	18
31110DT0421M10	42 G 1	22,2	403,2	892	18
31110DT0501M10	50 G 1	23,9	480	1050	18
31110DT0611M10	61 G 1	25,3	585,6	1262	18
31110DT1020M15	2 x 1,5	8,7	28,8	114	16
31110DT0031M15	3 G 1,5	9,1	43,2	141	16
31110DT0041M15	4 G 1,5	9,9	57,6	168	16
31110DT0051M15	5 G 1,5	10,6	72	194	16
31110DT0071M15	7 G 1,5	11,5	100,8	237	16
31110DT0121M15	12 G 1,5	14,9	172,8	414	16
31110DT0181M15	18 G 1,5	17,2	259,2	558	16
31110DT0251M15	25 G 1,5	19,8	360	753	16
31110DT0341M15	34 G 1,5	23	489,6	1000	16
31110DT0371M15	37 G 1,5	23	532,8	1032	16
31110DT0421M15	42 G 1,5	24,8	604,8	1196	16
31110DT0501M15	50 G 1,5	27	720	1424	16
31110DT0611M15	61 G 1,5	28,3	878,4	1622	16
31110DT1020M25	2 x 2,5	10,1	48	166	14
31110DT0031M25	3 G 2,5	10,6	72	194	14
31110DT0041M25	4 G 2,5	11,5	96	234	14
31110DT0051M25	5 G 2,5	12,6	120	289	14
31110DT0071M25	7 G 2,5	13,9	168	364	14
31110DT0121M25	12 G 2,5	17,8	288	603	14
31110DT0181M25	18 G 2,5	20,9	432	856	14
31110DT0251M25	25 G 2,5	23,9	600	1145	14
31110DT0341M25	34 G 2,5	28,1	816	1564	14
31110DT0031M40	3 G 4	12,3	115,2	277	12
31110DT0041M40	4 G 4	13,7	153,6	347	12
31110DT0051M40	5 G 4	14,9	192	428	12
31110DT0071M40	7 G 4	16,2	268,8	528	12

Other dimension and colours available on request.

GAALFLEX® CONTROL 500 P

PUR control cable, 300/500 V

ELETTROTEK KABEL® GAALFLEX® CONTROL 500 P

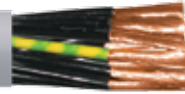

Construction:

Conductor:	flexible red copper conductor Cl.5, acc.to IEC 60228, DIN VDE 0295
Insulation:	PVC type Tl2
Colour cores:	black cores with consecutive numbers acc. to EN 50334, green-yellow from 3 cores
Stranding:	in layers
Outer sheath:	grey (RAL 7001), PUR special compound

Resistance:



Oil resistance:
DIN VDE 0473 part 811-2-1
IEC EN 60811-2-1

Technical data:

Nominal voltage:	U ₀ /U 300/500 V
Test voltage:	3 kV acc.to DIN VDE 0281 part 2 + HD 21.2
Temperature range	
<i>Fixed laying:</i>	-40°C up to +80°C
<i>Flexible installation:</i>	-5°C up to +70°C
Min. bending radius	
<i>Fixed laying:</i>	4 x d
<i>Flexible installation:</i>	12,5 x d

Features:

abrasion resistant
notch resistant
on request black outer sheath
good against acids, alkalines, solvents,hydraulic liquids etc.
RoHS and CE approval



CONTROL AND CONNECTION CABLES

GAALFLEX® CONTROL 500 P

PUR control cable, 300/500 V

ELETTROTEK KABEL® GAALFLEX® CONTROL 500 P

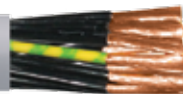

Part no.	No. of cores x cross section n x mm ²	Outer-Ø ca. mm ± 10%	Copper weight kg/km	Cable weight approx. kg/km	AWG no. *)
31060D51020M07	2 x 0,75	5,7	14,4	39	19
31060D50031M07	3 G 0,75	5,9	21,6	51	19
31060D50041M07	4 G 0,75	6,4	28,8	62	19
31060D50051M07	5 G 0,75	7	36	75	19
31060D50071M07	7 G 0,75	7,6	50,4	95	19
31060D50121M07	12 G 0,75	9,4	86,4	158	19
31060D50181M07	18 G 0,75	12,1	129,6	225	19
31060D50201M07	20 G 0,75	12,7	144	248	19
31060D50251M07	25 G 0,75	14,8	180	312	19
31060D51020M10	2 x 1	5,9	19,2	44	18
31060D50031M10	3 G 1	6,1	28,8	59	18
31060D50041M10	4 G 1	6,6	38,4	72	18
31060D50051M10	5 G 1	7,3	48	87	18
31060D50071M10	7 G 1	7,9	67,2	112	18
31060D50121M10	12 G 1	10,8	115,2	185	18
31060D50181M10	18 G 1	12,6	172,8	267	18
31060D50201M10	20 G 1	13,2	192	294	18
31060D50251M10	25 G 1	15,4	240	369	18
31060D51020M15	2 x 1,5	6,5	28,8	56	16
31060D50031M15	3 G 1,5	6,8	43,2	76	16
31060D50041M15	4 G 1,5	7,4	57,6	94	16
31060D50051M15	5 G 1,5	8,1	72	115	16
31060D50071M15	7 G 1,5	8,8	100,8	148	16
31060D50121M15	12 G 1,5	12,1	172,8	245	16
31060D50181M15	18 G 1,5	14,5	259,2	367	16
31060D50201M15	20 G 1,5	15,2	288	404	16
31060D50251M15	25 G 1,5	17,3	360	497	16
31060D51020M25	2 G 2,5	7,7	48	83	14
31060D50031M25	3 G 2,5	8,1	72	115	14
31060D50041M25	4 G 2,5	8,8	96	144	14
31060D50051M25	5 G 2,5	10,1	120	184	14
31060D50071M25	7 G 2,5	11	168	238	14
31060D50121M25	12 G 2,5	14,9	288	391	14
31060D50181M25	18 G 2,5	17,9	432	582	14
31060D50201M25	20 G 2,5	18,8	480	636	14
31060D50251M25	25 G 2,5	21,8	600	800	14
31060D50031M40	3 G 4	11,7	115,2	227	12
31060D50041M40	4 x 4	12,6	153,6	275	12
31060D50051M40	5 x 4	13,7	192	330	12
31060D50031M60	3 x 6	14	172,8	333	10
31060D50041M60	4 x 6	15,1	230,4	404	10
31060D50051M60	5 x 6	16,4	288	482	10
31060D50041M61	4 x 10	18,9	384	656	8

Other dimension and colours available on request.

CONTROL AND CONNECTION CABLES

GAALFLEX® CONTROL 500 P orange

PUR control cable with coloured cores, 300/500 V

ELETTROTEK KABEL® GAALFLEX® CONTROL 500 P orange



Construction:

Conductor:	flexible red copper conductor Cl.5, acc.to IEC 60228, DIN VDE 0295
Insulation:	PVC type Tl2
Colour cores:	acc. to DIN VDE 0293-308, HD 308 S2, green-yellow earth-wire from 3 cores
Stranding:	in layers
Outer sheath:	orange (RAL 2003) PUR type TMPU

Resistance:



Oil resistance:
DIN VDE 0473 part 811-2-1
IEC EN 60811-2-1

Technical data:

Nominal voltage:	U ₀ /U 300/500 V
Test voltage:	3 kV acc.to DIN VDE 0281 part 2 + HD 21.2
Temperature range	
<i>Fixed laying:</i>	-40°C up to +70°C
<i>Flexible installation:</i>	-5°C up to +70°C
Min. bending radius	
<i>Fixed laying:</i>	4 x d
<i>Flexible installation:</i>	6 x d

Features:

abrasion resistant
notch resistant
acc.to DIN VDE 0250
good against acids, alkalines, solvents,hydraulic liquids etc.
RoHS and CE approval



Part no.	No.of cores x cross section n x mm ²	Outer-Ø ca.mm ± 10%	Copper weight kg/km	Cable weight approx. kg/km	AWG no.*)
31070DG3020M07	2 x 0,75	5,7	14,4	39	19
31070DG2031M07	3 G 0,75	5,9	21,6	51	19
31070DG2041M07	4 G 0,75	6,4	28,8	62	19
31070DG2051M07	5 G 0,75	7	36	75	19
31070DG3020M10	2 x 1	5,9	19,2	44	18
31070DG2031M10	3 G 1	6,1	28,8	59	18
31070DG2041M10	4 G 1	6,6	38,4	72	18
31070DG2051M10	5 G 1	7,3	48	87	18
31070DG3020M15	2 x 1,5	6,5	28,8	56	16
31070DG2031M15	3 G 1,5	6,8	43,2	76	16
31070DG2041M15	4 G 1,5	7,4	57,6	94	16
31070DG2051M15	5 G 1,5	8,1	72	115	16
31070DG3020M25	2 x 2,5	7,7	48	83	14
31070DG2031M25	3 G 2,5	8,1	72	115	14
31070DG2041M25	4 G 2,5	8,8	96	144	14
31070DG2051M25	5 G 2,5	10,1	120	184	14

Other dimension and colours available on request.

GAALFLEX® CONTROL 500 CP Lean

PUR control cable with overall copper screen, 300/500 V

ELETTROTEK KABEL® GAALFLEX® CONTROL 500 CP Lean

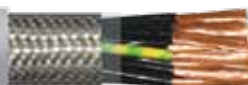

Construction:

Conductor:	flexible red copper conductor Cl.5, acc.to IEC 60228, DIN VDE 0295
Insulation:	PVC type Tl1
Colour cores:	black cores with consecutive numbers acc. to EN 50334, green-yellow from 3 cores
Stranding:	in layers
Wrapping:	PETP foil
Screen:	tinned copper braid
Outer sheath:	grey (RAL 7001) PUR special compound

Resistance:



Oil resistance:

DIN VDE 0282 part 10 + HD 22.10
DIN VDE 0473 part 811-2-1
IEC EN 60811-2-1
very good-TMPU

Technical data:

Nominal voltage:	Uo/U 300/500 V
Test voltage:	3 kV
Temperature range	
<i>Fixed laying:</i>	-40°C up to +80°C
<i>Flexible application:</i>	-5°C up to + 70°C
Min. bending radius	
<i>Fixed laying:</i>	6 x d
<i>Flexible application:</i>	20 x d

Features:

abrasion resistant
notch resistant
good EMC characteristics
chemical resistant
RoHS and CE approval



CONTROL AND CONNECTION CABLES

GAALFLEX® CONTROL 500 CP Lean

PUR control cable with overall copper screen, 300/500 V

ELETTROTEK KABEL® GAALFLEX® CONTROL 500 CP Lean

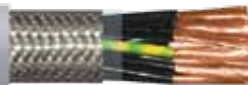

Part no.	No. of cores x cross section n x mm ²	Outer-Ø ca. mm ± 10%	Copper weight kg/km	Cable weight approx. kg/km	AWG no. *)
31100D51020M05	2 x 0,5	5,3	23,6	35	20
31100D50031M05	3 G 0,5	5,6	30,3	43	20
31100D50041M05	4 G 0,5	6	36,7	53	20
31100D50051M05	5 G 0,5	6,5	43,5	64	20
31100D50071M05	7 G 0,5	7	53,3	77	20
31100D50121M05	12 G 0,5	9	86,5	122	20
31100D50181M05	18 G 0,5	11,1	140,2	196	20
31100D50251M05	25 G 0,5	13	179,8	250	20
31100D51020M07	2 x 0,75	5,9	30,4	44	19
31100D50031M07	3 G 0,75	6,2	39,2	55	19
31100D50041M07	4 G 0,75	6,7	48,3	67	19
31100D50051M07	5 G 0,75	7,3	57,6	83	19
31100D50071M07	7 G 0,75	7,9	74,1	102	19
31100D50121M07	12 G 0,75	10,8	134,1	181	19
31100D50181M07	18 G 0,75	12,5	189,1	257	19
31100D50251M07	25 G 0,75	15,4	277,5	366	19
31100D51020M10	2 x 1	6,1	36,8	50	18
31100D50031M10	3 G 1	6,4	46,5	62	18
31100D50041M10	4 G 1	6,9	58	77	18
31100D50051M10	5 G 1	7,6	71,6	96	18
31100D50071M10	7 G 1	8,2	93,3	120	18
31100D50121M10	12 G 1	11,2	169,1	213	18
31100D50181M10	18 G 1	13,2	232,2	298	18
31100D50251M10	25 G 1	16,2	378,1	424	18
31100D51020M15	2 x 1,5	6,7	48,3	62	16
31100D50031M15	3 G 1,5	7,1	64,7	80	16
31100D50041M15	4 G 1,5	7,7	81,2	100	16
31100D50051M15	5 G 1,5	8,4	98,1	121	16
31100D50071M15	7 G 1,5	9,1	129,8	157	16
31100D50121M15	12 G 1,5	12,5	232,3	276	16
31100D50181M15	18 G 1,5	15,1	356,4	427	16
31100D50251M15	25 G 1,5	18,3	471,5	575	16
31100D51020M25	2 x 2,5	7,9	71,7	91	14
31100D50031M25	3 G 2,5	8,4	98,1	118	14
31100D50041M25	4 G 2,5	9,1	125	148	14
31100D50051M25	5 G 2,5	10,5	167,5	202	14
31100D50071M25	7 G 2,5	11,5	222,1	259	14
31100D50121M25	12 G 2,5	15,6	385,7	446	14
31100D50181M25	18 G 2,5	18,5	554,9	657	14
31100D50251M25	25 G 2,5	22,4	740,3	877	14
31100D50031M40	3 G 4	10	144,4	177	12
31100D50041M40	4 G 4	11,1	207,4	235	12
31100D50051M40	5 G 4	12,2	251,3	292	12
31100D50041M60	4 G 6	12,8	290,1	331	10
31100D50051M60	5 G 6	14,5	354,5	417	10
31100D50041M61	4 G 10	16,8	494	577	8

Other dimension and colours available on request.

GAALFLEX® CONTROL 540 P

PUR control cable with coloured cores, 300/500 and 450/750 V



ELETTROTEK KABEL® GAALFLEX® CONTROL 540 P



Construction:

Conductor:	flexible red copper conductor Cl.5, acc.to IEC 60228, DIN VDE 0295
Insulation:	halogen-free compound
Colour cores:	acc. to DIN VDE 0293-308, HD 308 S2, green-yellow earth-wire from 3 cores
Stranding:	in layers
Outer sheath:	yellow (RAL 1021) PUR type Tmpu

Resistance:



Flame retardant and Self-extinguishing acc. to:
DIN VDE 0482 part 265-2-1
EN 50265-2-1
IEC 60332-1-2



Halogen-free acc. to
DIN VDE 0472, part 815
EN 50267-2-1
IEC 60754-1



Corrosiveness of conflagration gases acc. to:
DIN VDE 0472 part 267-2-2
EN 50267-2-2
IEC 60754-2



Oil resistance:
DIN VDE 0282 part 10 + HD 22.10
DIN VDE 0473 part 811-2-1
IEC EN 60811-2-1
very good-Tmpu

Technical data:

Nominal voltage:	U ₀ /U 300/500 V from 0.75 mm ² to 1mm ² U ₀ /U 450/750 V from 1 mm ² to 16mm ²
Test voltage:	3 kV acc.to DIN VDE 0281 part 2 + HD 21.2
Temperature range	
<i>Fixed laying:</i>	-40°C up to +90°C
<i>Flexible installation:</i>	-15°C up to +90°C
Min. bending radius	
<i>Fixed laying:</i>	4 x d
<i>Flexible installation:</i>	6 x d

Features:

- abrasion resistant
- notch resistant
- chemical resistant
- RoHS and CE approval



CONTROL AND CONNECTION CABLES

GAALFLEX® CONTROL 540 P

PUR control cable with coloured cores, 300/500 and 450/750 V



ELETTROTEK KABEL® GAALFLEX® CONTROL 540 P



300/500 V

Part no.	No. of cores x cross section n x mm ²	Outer-Ø ca. mm ± 10%	Copper weight kg/km	Cable weight approx. kg/km	AWG no. *)
31120DY3020M07	2 x 0,75	6,2	14,4	48	19
31120DY2031M07	3 G 0,75	6,7	21,6	61	19
31120DY2041M07	4 G 0,75	7,3	28,8	75	19
31120DY2051M07	5 G 0,75	8,2	36	95	19
31120DY3020M10	2 x 1	6,7	19,2	58	18
31120DY2031M10	3 G 1	7,1	28,8	71	18
31120DY2041M10	4 G 1	7,7	38,4	87	18
31120DY2051M10	5 G 1	8,6	48	110	18

Other dimension and colours available on request.

450/750 V

Part no.	No. of cores x cross section n x mm ²	Outer-Ø ca. mm ± 10%	Copper weight kg/km	Cable weight approx. kg/km	AWG no. *)
31120EY3020M10	2 x 1	7,5	19,2	69	18
31120EY2031M10	3 G 1	7,9	28,8	84	18
31120EY2041M10	4 G 1	8,8	38,4	106	18
31120EY2051M10	5 G 1	9,9	48	135	18
31120EY3020M15	2 x 1,5	8,3	28,8	87	16
31120EY2031M15	3 G 1,5	8,8	43,2	106	16
31120EY2041M15	4 G 1,5	9,8	57,6	134	16
31120EY2051M15	5 G 1,5	10,7	72	167	16
31120EY3020M25	2 x 2,5	9,8	48	127	14
31120EY2031M25	3 G 2,5	10,4	72	158	14
31120EY2041M25	4 G 2,5	11,5	96	198	14
31120EY2051M25	5 G 2,5	12,9	120	252	14
31120EY3020M40	2 x 4	11,4	76,8	182	12
31120EY2031M40	3 G 4	12,1	115,2	229	12
31120EY2041M40	4 G 4	13,4	153,6	289	12
31120EY2051M40	5 G 4	15	192	365	12
31120EY3020M60	2 x 6	12,8	115,2	242	10
31120EY2031M60	3 G 6	13,8	172,8	312	10
31120EY2041M60	4 G 6	15,2	230,4	393	10
31120EY2051M60	5 G 6	17	288	496	10
31120EY3020M61	2 x 10	17,1	192	428	8
31120EY2031M61	3 G 10	18,3	288	546	8
31120EY2041M61	4 G 10	20,1	384	684	8
31120EY2051M61	5 G 10	22,3	480	856	8
31120EY3020M62	2 x 16	19,8	307	608	6
31120EY2031M62	3 G 16	21,4	460,8	792	6
31120EY2041M62	4 G 16	23,3	614,4	988	6
31120EY2051M62	5 G 16	26,1	768	1248	6

Other dimension and colours available on request.

CONTROL AND CONNECTION CABLES

GAALFLEX® CONTROL 540 CP

PUR control cable with coloured cores, inner sheath and overall copper screen, 300/500 and 450/750 V



ELETTROTEK KABEL® GAALFLEX® CONTROL 540 CP

Construction:

Conductor:	flexible red copper conductor Cl.5, acc.to IEC 60228, DIN VDE 0295
Insulation:	halogen-free compound
Colour cores:	acc. to DIN VDE 0293-308, HD 308 S2, green-yellow earth-wire from 3 cores
Stranding:	in layers
Inner sheath:	yellow (RAL 1021) Halogen free compound
Screen:	tinned copper braid
Wrapping:	non woven tapee
Outer sheath:	yellow (RAL 1021) PUR type TMPU

Resistance:



Flame retardant and Self-extinguishing acc. to:
DIN VDE 0482 part 265-2-1
EN 50265-2-1
IEC 60332-1-2



Halogen-free acc. to
DIN VDE 0482, part 267
EN 50267-2-1
IEC 60754-1



Corrosiveness of conflagration gases acc. to:
DIN VDE 0482 part 267
EN 50267-2-2
IEC 60754-2



Oil resistance:
DIN VDE 0282 part 10 + HD 22.10
DIN VDE 0473 part 811-2-1
IEC EN 60811-2-1
very good-TMPU

Technical data:

Nominal voltage:	U ₀ /U 300/500 V from 0.75 mm ² to 1mm ² U ₀ /U 450/750 V from 1 mm ² to 16mm ²
Test voltage:	3 kV acc.to DIN VDE 0281 part 2 + HD 21.2
Temperature range	
<i>Fixed laying:</i>	-40°C up to +90°C
<i>Flexible installation:</i>	-30°C up to +90°C
Min. bending radius	
<i>Fixed laying:</i>	5 x d
<i>Flexible installation:</i>	10 x d

Features:

abrasion resistant
notch resistant
chemical resistant
RoHS and CE approval



CONTROL AND CONNECTION CABLES

GAALFLEX® CONTROL 540 CP

PUR control cable with coloured cores, inner sheath and overall copper screen, 300/500 and 450/750 V



ELETTROTEK KABEL® GAALFLEX® CONTROL 540 CP

300/500 V

Part no.	No. of cores x cross section n x mm ²	Outer-Ø ca. mm ± 10%	Copper weight kg/km	Cable weight approx. kg/km	AWG no. *)
31130DY3020M07	2 x 0,75	8,5	31	103	19
31130DY2031M07	3 G 0,75	9	38,4	115	19
31130DY2041M07	4 G 0,75	9,6	45,9	130	19
31130DY2051M07	5 G 0,75	10,5	56,8	157	19
31130DY3020M10	2 x 1	9	36,8	116	18
31130DY2031M10	3 G 1	9,4	45,8	128	18
31130DY2041M10	4 G 1	10	59,1	148	18
31130DY2051M10	5 G 1	10,9	69	175	18

Other dimension and colours available on request.

450/750 V

Part no.	No. of cores x cross section n x mm ²	Outer-Ø ca. mm ± 10%	Copper weight kg/km	Cable weight approx. kg/km	AWG no. *)
31130EY3020M10	2 x 1	9,8	36,4	135	18
31130EY2031M10	3 G 1	10,4	49,6	154	18
31130EY2041M10	4 G 1	11,1	59,5	174	18
31130EY2051M10	5 G 1	12,4	73	216	18
31130EY3020M15	2 x 1,5	10,6	49,7	164	16
31130EY2031M15	3 G 1,5	11,1	64,3	179	16
31130EY2041M15	4 G 1,5	12,3	82,6	218	16
31130EY2051M12	5 G 1,5	13,6	109,7	273	16
31130EY3020M25	2 G 2,5	12,3	73	229	14
31130EY2031M25	3 G 2,5	12,9	97,3	254	14
31130EY2041M25	4 G 2,5	14,2	134,2	310	14
31130EY2051M25	5 G 2,5	15,6	159,2	369	14
31130EY3020M40	2 x 4	14,1	114,9	317	12
31130EY2031M40	3 G 4	15	153,9	360	12
31130EY2041M40	4 G 4	16,3	198,3	428	12
31130EY2051M40	5 G 4	17,9	237,7	512	12
31130EY3020M60	2 x 6	15,5	154,3	396	10
31130EY2031M60	3 G 6	16,5	217,7	460	10
31130EY2041M60	4 G 6	17,9	276,1	543	10
31130EY2051M60	5 G 6	19,9	340,5	668	10
31130EY3020M61	2 x 10	19,2	244	628	8
31130EY2031M61	3 G 10	20,2	340,7	719	8
31130EY2041M61	4 G 10	22,2	444,2	870	8
31130EY2051M61	5 G 10	24,6	548,8	1066	8
31130EY3020M62	2 x 16	22,1	367,3	871	6
31130EY2031M62	3 G 16	23,5	521,8	1018	6
31130EY2041M62	4 G 16	25,8	684	1237	6
31130EY2051M62	5 G 16	28,6	846,6	1514	6

Other dimension and colours available on request.

CONTROL AND CONNECTION CABLES

GAALFLEX® CONTROL 750 BCY Lean

PVC control cables with coloured cores and overall copper screen, 450/750 V

ELETTROTEK KABEL® GAALFLEX® CONTROL 750 BCY Lean

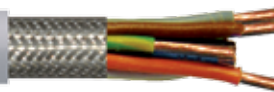

Construction:

Conductor:	flexible red copper conductor Cl.5, acc.to IEC 60228, DIN VDE 0295
Insulation:	PVC type T11
Colour cores:	acc. to DIN VDE 0293-308, HD 308 S2, JB/OB color code green-yellow earth-wire from 3 cores
Stranding:	in layers
Screen:	tinned copper braid
Outer sheath:	grey (RAL 7001), PVC type TM2

Resistance:



Flame retardant and Self-extinguishing acc. to:
DIN VDE 0482 part 265-2-1
EN 50265-2-1
IEC 60332-1-2

Technical data:

Nominal voltage:	U ₀ /U 450/750 V
Test voltage:	4 kV
Temperature range	
<i>Fixed laying:</i>	-40°C up to +80°C
<i>Flexible installation:</i>	-5°C up to +80°C
Min. bending radius	7,5 x d

Features:

flexible
oil resistant
RoHS and CE approval



Part no.	No. of cores x cross section n x mm ²	Outer-Ø ca.mm ± 10%	Copper weight kg/km	Cable weight approx. kg/km	AWG no.*)
31210E53020M05	2 x 0,5	5,4	22,4	44	20
31210E52031M05	3 G 0,5	5,7	27,3	51	20
31210E52041M05	4 G 0,5	6,1	32,2	61	20
31210E52051M05	5 G 0,5	6,9	41,7	79	20
31210E52071M05	7 G 0,5	7,6	56	101	20
31210E52121M05	12 G 0,5	9,7	90,1	159	20
31210E52141M05	14 G 0,5	10,1	99,8	176	20
31210E52161M05	16 G 0,5	10,8	109,2	198	20
31210E52181M05	18 G 0,5	11,4	123,6	222	20
31210E52251M05	25 G 0,5	13,5	178,1	310	20
31210E52341M05	34 G 0,5	15,7	229,3	405	20
31210E53020M07	2 x 0,75	5,8	27,3	51	19
31210E52031M07	3 G 0,75	6,1	34,6	61	19
31210E52041M07	4 G 0,75	6,8	46,3	80	19
31210E52051M07	5 G 0,75	7,4	53,9	94	19
31210E52071M07	7 G 0,75	8,2	73,3	122	19
31210E52121M07	12 G 0,75	10,7	119	199	19
31210E52141M07	14 G 0,75	11,2	137,8	226	19
31210E52161M07	16 G 0,75	11,9	152,3	255	19
31210E52181M07	18 G 0,75	12,6	171,3	285	19
31210E52251M07	25 G 0,75	14,9	246	397	19
31210E52341M07	34 G 0,75	17,3	319	519	19
31210E52371M07	37 G 0,75	17,3	340,6	544	19
31210E52421M07	42 G 0,75	18,6	385,1	630	19
31210E52501M07	50 G 0,75	20,2	450,8	723	19
31210E52611M07	61 G 0,75	21,7	538,3	857	19

CONTROL AND CONNECTION CABLES

GAALFLEX® CONTROL 750 BCY Lean

PVC control cables with coloured cores and overall copper screen, 300/500 and 450/750 V

ELETTROTEK KABEL® GAALFLEX® CONTROL 750 BCY Lean

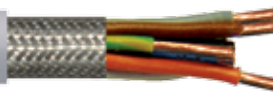

Part no.	No. of cores x cross section n x mm ²	Outer-Ø ca. mm ± 10%	Copper weight kg/km	Cable weight approx. kg/km	AWG no. *)
31210E53020M10	2 x 1	6,1	32,2	58	18
31210E52031M10	3G1	6,7	46,3	77	18
31210E52041M10	4 G 1	7,2	56,3	92	18
31210E52051M10	5 G 1	7,8	66	108	18
31210E52071M10	7 G 1	8,6	95	146	18
31210E52121M10	12 G 1	11,3	152,6	236	18
31210E52141M10	14 G 1	12	171,5	269	18
31210E52161M10	16 G 1	12,6	195,3	303	18
31210E52181M10	18 G 1	13,7	230,4	357	18
31210E52251M10	25 G 1	15,7	306,1	464	18
31210E52341M10	34 G 1	18,5	409,1	627	18
31210E52371M10	37 G 1	18,5	437,9	658	18
31210E52421M10	42 G 1	20	494,2	761	18
31210E52501M10	50 G 1	21,7	579,1	873	18
31210E52611M10	61 G 1	23,4	692,8	1046	18
31210E53020M15	2 x 1,5	6,9	46,5	79	16
31210E52031M15	3G1,5	7,3	61,1	95	16
31210E52041M15	4 G 1,5	8,1	80	124	16
31210E52051M15	5 G 1,5	8,8	94,4	147	16
31210E52071M15	7 G 1,5	9,7	133,3	195	16
31210E52121M15	12 G 1,5	12,7	214,5	315	16
31210E52141M15	14 G 1,5	13,7	259,2	378	16
31210E52161M15	16 G 1,5	14,4	296,6	428	16
31210E52181M15	18 G 1,5	15,4	325,3	478	16
31210E52251M15	25 G 1,5	17,8	434,1	630	16
31210E52341M15	34 G 1,5	21	580,5	850	16
31210E52371M15	37 G 1,5	21	623,7	895	16
31210E52421M15	42 G 1,5	22,6	704,3	1032	16
31210E52501M15	50 G 1,5	25	861,8	1235	16
31210E52611M15	61 G 1,5	26,6	1033,5	1464	16
31210E53020M25	2 x 2,5	9,7	74,9	140	14
31210E52031M25	3 G 2,5	10,2	99	170	14
31210E52041M25	4 G 2,5	11,3	127,4	224	14
31210E52051M25	5 G 2,5	12,6	155,9	273	14
31210E52071M25	7 G 2,5	11,9	205,1	296	14
31210E52121M25	12 G 2,5	15,8	354,1	500	14
31210E52141M25	14 G 2,5	16,7	410,7	579	14
31210E52161M25	16 G 2,5	17,7	458,3	653	14
31210E52181M25	18 G 2,5	18,7	514,5	730	14
31210E52251M25	25 G 2,5	21,7	699,1	973	14
31210E52341M25	34 G 2,5	25,9	958	1346	14
31210E53020M40	2 x 4	11,1	108,2	190	12
31210E52031M40	3 G 4	11,8	146,5	236	12
31210E52041M40	4 G 4	13,1	189,6	311	12
31210E52051M40	5 G 4	14,7	247,6	396	12
31210E53020M60	2 x 6	12,4	146,7	244	10
31210E52031M60	3 G 6	13,2	208,7	312	10
31210E52041M60	4 G 6	14,8	286,3	429	10
31210E52051M60	5 G 6	16,4	351,7	523	10
31210E52031M61	3 G 10	16,9	351,7	519	8
31210E52041M61	4 G 10	18,7	455,7	682	8
31210E52051M61	5 G 10	20,8	559,8	832	8
31210E52031M62	3 G 16	19,8	705,2	900	6
31210E52041M62	4 G 16	21,5	640	969	6
31210E52051M62	5 G 16	24	855,6	1193	6
31210E52041M63	4 G 25	26,6	1063,7	1480	4
31210E52051M63	5 G 25	29,9	1311,5	1834	4
31210E52041M64	4 G 35	30	1455,8	1956	2
31210E52051M64	5 G 35	33,7	1841,9	2450	2
31210E52051M65	4 G 50	36	2094,3	2795	1
31210E52051M66	4 G 70	41,8	2887,3	3808	2/0
31210E52051M67	4 G 95	46,9	3872,1	4962	3/0

Other dimension and colours available on request.

CONTROL AND CONNECTION CABLES

GAALFLEX® CONTROL 1000

PVC control cable, 0,6/1 kV

ELETTROTEK KABEL® GAALFLEX® CONTROL 1000



Construction:

Conductor:	flexible red copper conductor Cl.5, acc.to IEC 60228, DIN VDE 0295
Insulation:	PVC type T11
Colour cores:	black cores with consecutive numbers acc. to EN 50334, green-yellow from 3 cores
Stranding:	in layers
Outer sheath:	black (RAL 9005), PVC type TM2

Resistance:



Flame retardant and Self-extinguishing acc. to:
DIN VDE 0482 part 265-2-1
EN 50265-2-1
IEC 60332-1-2

Technical data:

Nominal voltage:	U ₀ /U 0,6/1 kV
Test voltage:	4 kV
Temperature range	
<i>Fixed laying:</i>	-40°C up to +80°C
<i>Flexible installation:</i>	-5°C up to +70°C
Min. bending radius	
<i>Fixed laying:</i>	4 x d
<i>Flexible installation:</i>	15 x d

Features:

UV resistant
Oil and chemical resistant
RoHS and CE approval



CONTROL AND CONNECTION CABLES

GAALFLEX® CONTROL 1000

PVC control cable, 0,6/1 kV

ELETTROTEK KABEL® GAALFLEX® CONTROL 1000



Part no.	No. of cores x cross section n x mm ²	Outer-Ø ca. mm ± 10%	Copper weight kg/km	Cable weight approx. kg/km	AWG no. *)
31220G71020M05	2 x 0,5	7,8	9,6	79	20
31220G70041M05	4 G 0,5	8,7	19,2	103	20
31220G70061M05	6 G 0,5	10	28,8	138	20
31220G70081M05	8 G 0,5	11,3	38,4	178	20
31220G70101M05	10 G 0,5	12	48	204	20
31220G70121M05	12 G 0,5	12,3	57,6	220	20
31220G70141M05	14 G 0,5	12,8	67,2	242	20
31220G70161M05	16 G 0,5	13,4	76,8	267	20
31220G70181M05	18 G 0,5	14,2	86,4	298	20
31220G71020M07	2 x 0,75	8,2	14,4	90	19
31220G70041M07	4 G 0,75	9,2	28,8	120	19
31220G70061M07	6 G 0,75	10,6	43,2	163	19
31220G70081M07	8 G 0,75	12,0	57,6	211	19
31220G70101M07	10 G 0,75	12,8	72	244	19
31220G70121M07	12 G 0,75	13,1	86,4	265	19
31220G70141M07	14 G 0,75	13,7	100,8	293	19
31220G70181M07	18 G 0,75	15,1	129,6	362	19
31220G71020M10	2 x 1	8,5	19,2	99	18
31220G70041M10	4 G 1	9,5	38,4	134	18
31220G70061M10	6 G 1	11,0	57,6	184	18
31220G70081M10	8 G 1	12,6	76,8	240	18
31220G70101M10	10 G 1	13,4	96	279	18
31220G70121M10	12 G 1	13,8	115,2	305	18
31220G70141M10	14 G 1	14,4	134,4	338	18
31220G70161M10	16 G 1	15,0	153,6	375	18
31220G70181M10	18 G 1	15,9	172,8	420	18
31220G71020M15	2 x 1,5	9,5	28,8	126	16
31220G70031M15	3 G 1,5	10	43,2	148	16
31220G70041M15	4 G 1,5	10,7	57,6	176	16
31220G70061M15	6 G 1,5	12,5	86,4	246	16
31220G70081M15	8 G 1,5	14,3	115,2	324	16
31220G70101M15	10 G 1,5	15,3	144	379	16
31220G70121M15	12 G 1,5	15,8	172,8	416	16
31220G70141M15	14 G 1,5	16,5	201,6	464	16
31220G70161M15	16 G 1,5	17,3	230,4	517	16
31220G70181M15	18 G 1,5	18,3	259,2	580	16
31220G70191M15	19 G 1,5	18,3	273,6	590	16
31220G71020M25	2 x 2,5	9,5	48	168	14
31220G70031M25	3 G 2,5	10	72	200	14
31220G70041M25	4 G 2,5	10,7	96	242	14
31220G70081M25	8 G 2,5	14,3	192	457	14
31220G70101M25	10 G 2,5	15,3	240	539	14
31220G70121M25	12 G 2,5	15,8	288	596	14
31220G70141M25	14 G 2,5	16,5	336	668	14
31220G70161M25	16 G 2,5	17,3	384	747	14
31220G70181M25	18 G 2,5	18,3	432	841	14
31220G71020M40	2 x 4	11,9	76,8	222	12
31220G70041M40	4 G 4	13,7	153,6	330	12
31220G70121M40	12 G 4	20,9	460,8	840	12
31220G71020M60	2 x 6	13,0	115,2	281	10
31220G70041M60	4 x 6	15,0	230,4	428	10
31220G70041M61	4 x 10	18,3	384	668	8
31220G70041M62	4 x 16	20,7	614,4	941	6
31220G70041M63	4 x 25	25,2	960	1.431	4
31220G70041M64	4 x 35	28,2	1.344	1.889	2
31220G70041M65	4 x 50	33,4	1.920	2.687	1

Other dimension and colours available on request.

CONTROL AND CONNECTION CABLES

GAALFLEX® CONTROL 1000 H

Halogen free control cable, 0,6/1 kV



ELETTROTEK KABEL® GAALFLEX® CONTROL 1000 H

Construction:

Conductor:	flexible red copper conductor Cl.5, acc.to IEC 60228, DIN VDE 0295
Insulation:	halogen-free compound type TI6
Colour cores:	black cores with consecutive numbers acc. to EN 50334, green-yellow from 3 cores
Stranding:	in layers
Outer sheath:	black (RAL 9005) ,halogen-free compound type TM7

Resistance:



Flame test acc.to
DIN VDE 0482 part 332-3
IEC 60332-3

Flame retardant and Self-extinguishing acc. to:
DIN VDE 0482 part 265-2-1
IEC 60332-1-2



Halogen-free acc. to
DIN VDE 0482, part 267
EN 50267-2-1
IEC 60754-1



Corrosiveness of conflagration gases acc. to:
DIN VDE 0482 part 267
EN 50267-2-2
IEC 60754-2



Low smoke density acc. to:
DIN VDE 0482 part. 268-1-2
IEC 61034-1-2

Technical data:

Nominal voltage:	U ₀ /U 0,6/1 kV
Test voltage:	4 kV
Temperature range	
<i>Fixed laying:</i>	-40°C up to +70°C
<i>Flexible installation:</i>	-5°C up to +70°C
Min. bending radius	15 x d

Features:

UV resistant
RoHS and CE approval



CONTROL AND CONNECTION CABLES

GAALFLEX® CONTROL 1000 H

Halogen free control cable, 0,6/1 kV



ELETTROTEK KABEL® GAALFLEX® CONTROL 1000 H

Part no.	No. of cores x cross section n x mm ²	Outer-Ø ca. mm ± 10%	Copper weight kg/km	Cable weight approx. kg/km	AWG no. *)
31240G71020M05	2 x 0,5	6,6	9,6	58	20
31240G70031M05	3 G 0,5	7	14,4	68	20
31240G70041M05	4 G 0,5	7,5	19,2	80	20
31240G70051M05	5 G 0,5	8,1	24	94	20
31240G70071M05	7 G 0,5	8,8	33,6	115	20
31240G70121M05	12 G 0,5	11,3	57,6	191	20
31240G70181M05	18 G 0,5	13,4	86,4	273	20
31240G70251M05	25 G 0,5	15,2	120	358	20
31240G70341M05	34 G 0,5	17,8	163,2	489	20
31240G71020M07	2 x 0,75	7	14,4	68	19
31240G70031M07	3 G 0,75	7,4	21,6	80	19
31240G70041M07	4 G 0,75	8	28,8	96	19
31240G70051M07	5 G 0,75	8,7	36	115	19
31240G70071M07	7 G 0,75	9,4	50,4	140	19
31240G70121M07	12 G 0,75	12,1	86,4	234	19
31240G70181M07	18 G 0,75	14,3	129,6	333	19
31240G70251M07	25 G 0,75	16,6	180	453	19
31240G70341M07	34 G 0,75	19,4	244,8	618	19
31240G70371M07	37 G 0,75	19,4	266,4	633	19
31240G71020M10	2 x 1	7,3	19,2	76	18
31240G70031M10	3 G 1	7,7	28,8	90	18
31240G70041M10	4 G 1	8,3	38,4	108	18
31240G70051M10	5 G 1	9,1	48	132	18
31240G70071M10	7 G 1	10	67,2	166	18
31240G70101M10	10 G 1	12,4	96	194	18
31240G70121M10	12 G 1	13	115,2	273	18
31240G70161M10	16 G 1	14,2	153,6	277	18
31240G70181M10	18 G 1	15,1	172,8	392	18
31240G70251M10	25 G 1	17,4	240	528	18
31240G70341M10	34 G 1	20,5	326,4	727	18
31240G70371M10	37 G 1	20,5	355,2	748	18
31240G71020M15	2 x 1,5	8,3	28,8	102	16
31240G70031M15	3 G 1,5	8,8	43,2	122	16
31240G70041M15	4 G 1,5	9,5	57,6	147	16
31240G70051M15	5 G 1,5	10,6	72	184	16
31240G70071M15	7 G 1,5	11,5	100,8	227	16
31240G70121M15	12 G 1,5	15	172,8	388	16
31240G70181M15	18 G 1,5	17,7	259,2	553	16
31240G70251M15	25 G 1,5	20,5	360	751	16
31240G70341M15	34 G 1,5	24,1	489,6	1032	16
31240G70371M15	37 G 1,5	24,1	532,8	1063	16
31240G71020M25	2 x 2,5	9,5	48	141	14
31240G70031M25	3 G 2,5	10,2	72	174	14
31240G70041M25	4 G 2,5	11,1	96	214	14
31240G70051M25	5 G 2,5	12,2	120	261	14
31240G70071M25	7 G 2,5	13,5	168	334	14
31240G70121M25	12 G 2,5	17,6	288	570	14
31240G70181M25	18 G 2,5	20,9	432	823	14
31240G70251M25	25 G 2,5	24,2	600	1118	14
31240G70341M25	34 G 2,5	28,6	816	1545	14
31240G71020M40	2 x 4	10,9	76,8	195	12
31240G70031M40	3 G 4	11,6	115,2	241	12
31240G70041M40	4 G 4	12,9	153,6	305	12
31240G70051M40	5 G 4	14,1	192	371	12
31240G70071M40	7 G 4	15,4	268,8	471	12
31240G71020M60	2 x 6	12	115,2	252	10
31240G70031M60	3 G 6	13	172,8	322	10
31240G70041M60	4 G 6	14,2	230,4	402	10
31240G70051M60	5 G 6	15,6	288	492	10
31240G70071M60	7 G 6	17,3	403,2	640	10

Other dimension and colours available on request.

CONTROL AND CONNECTION CABLES

GAALFLEX® CONTROL 1000 H SC

Rigid or flexible halogen free Polyolefine Single-Core Ground Cable, 0,6/1 kV



Construction:

- Conductor:** stranded red copper conductor Cl. 2, acc to IEC 60228, DIN VDE 0295
- Insulation:** halogen-free type HM4, acc. to IEC 60092-353
- Colour cores:** green-yellow

Resistance:



Flame test acc.to
DIN VDE 0482 part 332-3
IEC 60332-3-A



Halogen-free acc. to
DIN VDE 0482, part 267
EN 50267-2-1
IEC 60754-1



Corrosiveness of conflagration gases acc. to:
DIN VDE 0482 part 267
EN 50267-2-2
IEC 60754-2



Low smoke density acc. to:
DIN VDE 0482 part. 268-1-2
IEC 61034-1-2

Technical data:

- Nominal voltage:** Uo/U 0,6/1 kV
- Test voltage:** 4 kV
- Temperature range**
Fixed laying: -35°C up to +85°C
Flexible installation: -5°C up to +85°C
- Min. bending radius**
Fixed laying: 8 x d
flexible installation: 16 x d

Features:

- on request class 5
- ozone resistance
- silicon free
- adapted to VDE 0295
- RoHS and CE approval



CLASS 2

Part no.	No. of cores x cross section n x mm ²	Outer-Ø ca. mm ± 10%	Copper weight kg/km	Cable weight approx. kg/km	AWG no. *)
31230G15011M15	1,5	3	14,4	22	16
31230G15011M25	2,5	3,5	24	30	14
31230G15011M40	4	4	38	45	12
31230G15011M60	6	4,5	58	70	10
31230G15011M62	16	6	154	170	6
31230G15011M63	25	8	240	265	4
31230G15011M64	35	9	336	365	2
31230G15011M65	50	10	480	510	1
31230G15011M66	70	12	672	725	2/0
31230G15011M67	95	14,3	912	970	3/0
31230G15011M68	120	16	1152	1230	4/0

CLASS 5

Part no.	No. of cores x cross section n x mm ²	Outer-Ø ca. mm ± 10%	Copper weight kg/km	Cable weight approx. kg/km	AWG no. *)
31231G15011M60	6	4,5	68	70	10
31231G15011M61	10	5,5	109	110	8
31231G15011M62	16	6,5	170	170	6
31231G15011M63	25	8,5	266	265	4
31231G15011M66	70	12,5	672	730	2/0
31231G15011M68	120	16	1152	1230	4/0

Other dimension and colours available on request.

CONTROL AND CONNECTION CABLES

GAALFLEX® CONTROL 1000 BH SC

Halogen-free control cable single conductors, 0,6/1 kV



ELETTROTEK KABEL® SPECIAL GAALFLEX® CONTROL 1000 BH SC



Construction:

- Conductor:** flexible red copper conductor Cl. 5, acc to IEC 60228, DIN VDE 0295
- Insulation:** halogen-free compound
- Colour cores:** L: (black), or N: (blue), or PE: (green/yellow)
- Outer sheath:** grey (RAL 7001) thermoplastic, halogen-free compound

Resistance:



Self-extinguishing and flame retardant acc. to:
DIN VDE 0482 part 332-1-2
EN 60332-1-2
IEC 60332-1-2



Halogen-free acc. to
DIN VDE 0482, part 267
EN 50267-2-1
IEC 60754-1



Corrosiveness of conflagration gases acc. to:
DIN VDE 0482 part 267
EN 50267-2-2
IEC 60754-2



Low smoke density acc. to:
DIN VDE 0482 part. 268-1-2
IEC 61034-1-2

Technical data:

- Nominal voltage:** U₀/U 0,6/1 kV
- Test voltage:** 4 kV
- Temperature range**
- Fixed laying:* -15°C up to +90°C
- Flexible installation:* 0°C up to +90°C
- Min. bending radius** 6 x d

Features:

- CEI 20-13 / 20-22 III, 20-37 (EN 50267)
- small bending radius
- RoHS and CE approval



Part no. L :black	Part no. N :blue	Part no. PE : g/y	No. of cores x cross section n x mm ²	Outer-Ø ca. mm ± 10%	Copper weight kg/km	Cable weight approx. kg/km	AWG no. *)
31250G5L010M62	31250G5N010M62	31250G5P011M62	1 x 16	9,6	153,6	206	6
31250G5L010M63	31250G5N010M63	31250G5P011M63	1 x 25	11,5	240	295	4
31250G5L010M64	31250G5N010M64	31250G5P011M64	1 x 35	12,5	336	359	2
31250G5L010M65	31250G5N010M65	31250G5P011M65	1 x 50	14,5	480	542	1
31250G5L010M66	31250G5N010M66	31250G5P011M66	1 x 70	16,4	672	739	2/0
31250G5L010M67	31250G5N010M67	31250G5P011M67	1 x 95	18	912	964	3/0
31250G5L010M68	31250G5N010M68	31250G5P011M68	1 x 120	20,3	1152	1189	4/0
31250G5L010M69	31250G5N010M69	31250G5P011M69	1 x 150	21,6	1440	1484	250 MCM
31250G5L010M70	31250G5N010M70	31250G5P011M70	1 x 185	24	1776	1780	350 MCM
31250G5L010M71	31250G5N010M71	31250G5P011M71	1 x 240	27	2304	2319	450 MCM
31250G5L010M72	31250G5N010M72	31250G5P011M72	1 x 300	29,3	2880	2877	550 MCM
31250G5L010M73	31250G5N010M73	31250G5P011M73	1 x 400	35,9	3840	4000	750 MCM

Other dimension and colours available on request.

GAALFLEX® CONTROL 1000 BH

Halogen-free control cable with coloured cores, 0,6/1 kV



ELETTROTEK KABEL® GAALFLEX® CONTROL 1000 BH



Construction:

Conductor:	flexible red copper conductor Cl.5, acc. to IEC 60228
Insulation:	halogen-free compound
Colour cores:	acc. to DIN VDE 0293-308, HD 308 S2 from 6 cores black cores with consecutive numbers acc. to EN 50334; green-yellow earth-wire from 3 cores
Inner sheath:	not hygroscopic filler
Outer Sheath:	grey (RAL 7001) thermoplastic, halogen-free compound

Technical data:

Nominal voltage:	0,6/1 kV
Test voltage:	4 kV
Temperature range:	- 15 °C / + 90 °C
Max short circuit temperature:	+ 250 °C
Min. bending radius	
<i>Power cables:</i>	4 x d
<i>Control cables:</i>	6 x d
Max. tensile stress:	50 N/mm ²

Resistance:



Self-extinguishing and flame retardant acc. to:
DIN VDE 0482 part 332-1-2
EN 60332-1-2
IEC 60332-1-2



Halogen-free acc. to
DIN VDE 0482, part 267
EN 50267-2-1
IEC 60754-1



Corrosiveness of conflagration gases acc. to:
DIN VDE 0482 part 267
EN 50267-2-2
IEC 60754-2



Low smoke density acc. to:
DIN VDE 0482 part. 268-1-2
IEC 61034-1-2

Features:

CEI 20-13 / 20-22 III, 20-37 (EN 50267)

small bending radius

RoHS and CE approval



CONTROL AND CONNECTION CABLES

GAALFLEX® CONTROL 1000 BH

Halogen-free control cable with coloured cores, 0,6/1 kV



ELETTROTEK KABEL® GAALFLEX® CONTROL 1000 BH



Part no.	No. of cores x cross section n x mm ²	Outer-Ø ca. mm ± 10%	Copper weight kg/km	Cable weight approx. kg/km	AWG no. *)
31260G53020M15	2x1,5	10	28,8	127	16
31260G53020M25	2x2,5	11	48	158	14
31260G53020M40	2x4	12,2	76,8	208	12
31260G53020M60	2x6	13,1	115,2	258	10
31260G53020M61	2x10	15,2	192	385	8
31260G53020M62	2x16	17,4	307,2	565	6
31260G53020M63	2x25	20,3	480	793	4
31260G53020M64	2x35	22,3	672	1037	2
31260G53020M65	2x50	26,2	960	1447	1
31260G53020M66	2x70	30,8	1344	2224	2/0
31260G53020M67	2x95	34,2	1824	2848	3/0
31260G53020M68	2x120	38,4	2304	3599	4/0
31260G53020M69	2x150	42,4	2880	3939	250 MCM
31260G52031M15	3G1,5	10,4	43,2	143	16
31260G52031M25	3G2,5	11,4	72	183	14
31260G52031M40	3G4	12,8	115,2	244	12
31260G52031M60	3G6	13,8	172,8	314	10
31260G52031M61	3G10	16,9	288	493	8
31260G52031M62	3G16	18,2	460,8	678	6
31260G52031M63	3G25	21,2	720	977	4
31260G52031M64	3G35	23,5	1008	1354	2
31260G52031M65	3G50	30	1440	1918	1
31260G52031M66	3G70	34	2016	2624	2/0
31260G52031M67	3G95	37,8	2736	3418	3/0
31260G52031M68	3G120	42,6	3456	4326	4/0
31260G52031M69	3G150	47,1	4320	5348	250 MCM
31260G52031M70	3G185	53,3	5328	6611	350 MCM
31260G52031M71	3G240	60,7	6912	8613	450 MCM
31260G52041M15	4G1,5	11,2	57,6	167	16
31260G52041M25	4G2,5	12,3	96	221	14
31260G52041M40	4G4	13,7	153,6	293	12
31260G52041M60	4G6	14,9	230,4	387	10
31260G52041M61	4G10	18	384	599	8
31260G52041M62	4G16	20,3	614,4	871	6
31260G52041M63	4G25	23,5	960	1239	4
31260G52035M64	3x35+25	26,3	1248	1589	2
31260G52035M65	3x50+25	30,3	1680	2116	1
31260G52035M66	3x70+35	35,7	2352	2975	2/0
31260G52035M67	3x95+50	41	3216	3971	3/0
31260G52035M68	3x120+70	45	4128	5219	4/0
31260G52035M69	3x150+95	52	5232	6511	250 MCM
31260G52035M70	3x185+95	56,72	6240	7669	350 MCM
31260G52035M71	3x240+150	65,5	8352	10279	450 MCM
31260G52051M15	5G1,5	12,1	72	197	16
31260G52051M25	5G2,5	13,5	120	262	14
31260G52051M40	5G4	15,2	192	361	12
31260G52051M60	5G6	16,6	288	476	10
31260G52051M61	5G10	19,6	480	756	8
31260G52051M62	5G16	22,5	768	1119	6
31260G52051M63	5G25	26,4	1200	1597	4
31260G51070M15	7G1,5	13,6	100,8	261	16
31260G51070M25	7G2,5	14,9	168	344	14
31260G51100M15	10G1,5	15,6	144	344	16
31260G51100M25	10G2,5	17,2	240	463	14
31260G51120M15	12G1,5	17	172,8	393	16
31260G51120M25	12G2,5	17,6	288	537	14
31260G51160M15	16G1,5	18,5	230,4	535	16
31260G51160M25	16G2,5	21,5	384	738	14
31260G51190M15	19G1,5	18,8	273,6	598	16
31260G51190M25	19G2,5	21,6	456	831	14
31260G51240M15	24G1,5	21,7	345,6	718	16
31260G51240M25	24G2,5	24,7	576	1029	14

Other dimension and colours available on request.

CONTROL AND CONNECTION CABLES

GAALFLEX® CONTROL 1000 SC CY

PVC control cable single conductor with overall screen, 0,6/1 kV

ELETTROTEK KABEL® GAALFLEX® CONTROL 1000 SC CY



ELETTROTEK KABEL® GAALFLEX® CONTROL 1000 SC CY



Construction:

Conductor:	flexible red copper conductor Cl. 5, acc. to IEC 60228, DIN VDE 0295
Insulation:	PVC type TI2
Colour cores:	black or green/yellow)
Screen:	tinned copper braid
Outer sheath:	black (RAL 9005), PVC type TM2, acc. to to DIN VDE 0281 part 1

Resistance:



Self-extinguishing and flame retardant acc. to:
DIN VDE 0482 part 265-2-1
EN 50265-2-1
IEC 60332-1-2



Oil resistance:
DIN VDE 0473 part 811-2-1
IEC EN 60811-2-1

Technical data:

Nominal voltage:	U ₀ /U 0,6/1 kV
Test voltage:	4 kV
Temperature range	
<i>Fixed laying:</i>	- 40°C up to + 80°C
<i>Flexible installation:</i>	- 5°C up to + 80°C
Min. bending radius	10 x d
Radiation resistance:	up to 80x10 ⁶ cJ/kg (up to 80 mrad)

Features:

chemical resistance
UV resistance
RoHS and CE approval



GREEN/YELLOW

Part no.	No. of cores x cross section n x mm ²	Outer-Ø ca. mm ± 10%	Copper weight kg/km	Cable weight approx. kg/km	AWG no. *)
31480G7P011M60	1 G 6	8,4	72	150	10
31480G7P011M61	1 G 10	9,8	130	240	8
31480G7P011M62	1 G 16	10,8	190	310	6
31480G7P011M63	1 G 25	12,4	260	430	4
31480G7P011M64	1 G 35	14,8	405	630	2
31480G7P011M65	1 G 50	16,8	560	840	1
31480G7P011M66	1 G 70	18,8	780	1100	2/0
31480G7P011M67	1 G 95	20,5	1030	1410	3/0
31480G7P011M68	1 G 120	23,5	1285	1780	4/0
31480G7P011M69	1 G 150	26,5	1430	1940	250 MCM
31480G7P011M70	1 G 185	29,8	1940	2650	350 MCM
31480G7P011M71	1 G 240	32,5	2530	3400	450 MCM

BLACK

Part no.	No. of cores x cross section n x mm ²	Outer-Ø ca. mm ± 10%	Copper weight kg/km	Cable weight approx. kg/km	AWG no. *)
31480G7L010M60	1 x 6	8,4	72	150	10
31480G7L010M61	1 x 10	9,8	130	240	8
31480G7L010M62	1 x 16	10,8	190	310	6
31480G7L010M63	1 x 25	12,4	260	430	4
31480G7L010M64	1 x 35	14,8	405	630	2
31480G7L010M65	1 x 50	16,8	560	840	1
31480G7L010M66	1 x 70	18,8	780	1100	2/0
31480G7L010M67	1 x 95	20,5	1030	1410	3/0
31480G7L010M68	1 x 120	23,5	1285	1780	4/0
31480G7L010M69	1 x 150	26,5	1430	1940	250 MCM
31480G7L010M70	1 x 185	29,8	1940	2650	350 MCM
31480G7L010M71	1 x 240	32,5	2530	3400	450 MCM

Other dimension and colours available on request.

CONTROL AND CONNECTION CABLES

GAALFLEX® CONTROL 1000 CY

PVC control cable. inner sheath with overall copper screen, 0,6/1 kV

ELETTROTEK KABEL® GAALFLEX® CONTROL 1000 CY

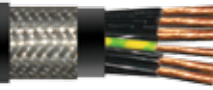

Construction:

Conductor:	flexible red copper conductor Cl. 5, acc to IEC 60228, DIN VDE 0295
Insulation:	PVC type T11
Colour cores:	black cores with consecutive numbers acc. to EN 50334, green-yellow from 3 cores
Stranding:	in layers
Inner sheath:	PVC type TM2
Screen:	tinned copper braid
Outer sheath:	black (RAL 9005), PVC type TM2,

Resistance:



Flame retardant acc. to:
EN 60332
IEC 60332-1-2

Technical data:

Nominal voltage:	U ₀ /U 0,6/1 kV
Test voltage:	4 kV
Temperature range	
<i>Fixed laying:</i>	- 40°C up to + 80°C
<i>Flexible installation:</i>	- 5°C up to + 70°C
Min. bending radius	
<i>Fixed laying:</i>	6 x d
<i>flexible installation:</i>	20 x d

Features:

UV resistance
RoHS and CE approval



Part no.	No. of cores x cross section n x mm ²	Outer-Ø ca. mm ± 10%	Copper weight kg/km	Cable weight approx. kg/km	AWG no. *)
31290G71020M05	2 x 0,5	9,8	32,4	117	20
31290G70031M05	3 G 0,5	10,2	42,1	135	20
31290G70041M05	4 G 0,5	10,7	47,1	150	20
31290G70051M05	5 G 0,5	11,3	56,6	173	20
31290G70071M05	7 G 0,5	12	66,2	198	20
31290G70121M05	12 G 0,5	14,7	115,4	313	20
31290G70181M05	18 G 0,5	16,6	152,6	408	20
31290G70251M05	25 G 0,5	18,4	202,5	519	20
31290G71020M07	2 x 0,75	10,2	42,1	135	19
31290G70031M07	3 G 0,75	10,6	49,6	149	19
31290G70041M07	4 G 0,75	11,2	56,7	169	19
31290G70051M07	5 G 0,75	11,9	68,5	197	19
31290G70071M07	7 G 0,75	12,6	87,5	231	19
31290G70121M07	12 G 0,75	15,5	152,5	369	19
31290G70181M07	18 G 0,75	17,5	203,9	481	19
31290G70251M07	25 G 0,75	19,8	270,8	629	19
31290G71020M10	2 x 1	10,5	47,1	145	18
31290G70031M10	3 G 1	10,9	56,7	161	18
31290G70041M10	4 G 1	11,5	70,9	188	18
31290G70051M10	5 G 1	12,3	80,6	216	18
31290G70071M10	7 G 1	13	104,4	254	18
31290G70121M10	12 G 1	16,2	181,3	414	18
31290G70181M10	18 G 1	18,3	255,5	553	18
31290G70251M10	25 G 1	20,6	330,9	708	18

CONTROL AND CONNECTION CABLES

GAALFLEX® CONTROL 1000 CY

PVC control cable. inner sheath with overall copper screen, 0,6/1 kV

ELETTROTEK KABEL® GAALFLEX® CONTROL 1000 CY

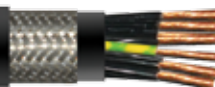

Part no.	No. of cores x cross section n x mm ²	Outer-Ø ca. mm ± 10%	Copper weight kg/km	Cable weight approx. kg/km	AWG no. *)
31290G71020M15	2 x 1,5	11,5	61,3	181	16
31290G70031M15	3 G 1,5	12	75,8	205	16
31290G70041M15	4 G 1,5	12,7	94,8	240	16
31290G70051M15	5 G 1,5	13,8	113,8	286	16
31290G70071M15	7 G 1,5	14,9	158,6	352	16
31290G70121M15	12 G 1,5	18,2	247,1	543	16
31290G70181M15	18 G 1,5	20,9	350,1	740	16
31290G70251M15	25 G 1,5	23,5	467,3	960	16
31290G71020M25	2 x 2,5	12,7	85,2	233	14
31290G70031M25	3 G 2,5	13,4	109,2	269	14
31290G70041M25	4 G 2,5	14,5	154	335	14
31290G70051M25	5 G 2,5	15,6	186	398	14
31290G70071M25	7 G 2,5	16,7	234,1	473	14
31290G70121M25	12 G 2,5	20,8	379	757	14
31290G70181M25	18 G 2,5	24,1	547,7	1053	14
31290G70251M25	25 G 2,5	27,2	732,1	1373	14
31290G71020M40	2 x 4	14,1	118,7	299	12
31290G70031M40	3 G 4	15	173,1	365	12
31290G70041M40	4 G 4	16,1	219,6	440	12
31290G70051M40	5 G 4	17,3	266,5	521	12
31290G70071M40	7 G 4	18,8	351,4	644	12
31290G70121M40	12 G 4	23,5	568,1	1034	12
31290G71020M60	2 x 6	15,4	181,2	387	10
31290G70031M60	3 G 6	16,2	238,9	457	10
31290G70041M60	4 G 6	17,4	304,8	553	10
31290G70051M60	5 G 6	19	370,6	667	10
31290G70071M60	7 G 6	20,5	494	825	10
31290G70031M61	3 G 10	19,3	370,6	679	8
31290G70041M61	4 G 10	20,9	474,9	830	8
31290G70051M61	5 G 10	22,8	587,3	1010	8
31290G70071M61	7 G 10	24,8	787,7	1264	8
31290G70031M62	3 G 16	21,5	560	924	6
31290G70041M62	4 G 16	23,3	721,7	1136	6
31290G70051M62	5 G 16	25,6	891,9	1391	6
31290G70071M62	7 G 16	27,8	1207,4	1757	6
31290G70041M63	4 G 25	28,2	1092,3	1696	4
31290G70051M63	5 G 25	31,3	1348,7	2096	4
31290G70071M63	7 G 25	34,2	1845,3	2678	4
31290G70041M64	4 G 35	31,4	1492,8	2204	2
31290G70051M64	5 G 35	34,9	1853,6	2736	2

Other dimension and colours available on request.

CONTROL AND CONNECTION CABLES

GAALFLEX® CONTROL 1000 CH

Halogen free control cable with overall copper screen, 0,6/1 kV



ELETTROTEK KABEL® GAALFLEX® CONTROL 1000 CH

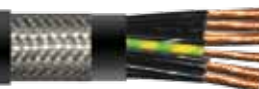

Construction:

Conductor:	flexible red copper conductor Cl. 5, acc to IEC 60228, DIN VDE 0295
Insulation:	halogen free compound type TI6
Colour cores:	black cores with consecutive numbers acc. to EN 50334, green-yellow from 3 cores
Stranding:	in layers
Inner sheath:	halogen free compound type TM7
Screen:	tinned copper braid
Outer sheath:	black (RAL 9005), halogen free compound type TM7

Resistance:



Self-extinguishing and flame retardant acc. to:
DIN VDE 0482 part 332-1-2
IEC 60332-1-2
IEC 60332-3-24



Halogen-free acc. to:
DIN VDE 0482, part 267
EN 50267-2-1
IEC 60754-1



Corrosiveness of conflagration gases acc. to:
DIN VDE 0482 part 267
EN 50267-2-2
IEC 60754-2



Low smoke density acc. to:
DIN VDE 0482 part. 268-1-2
EN 50268-1-2
IEC 61034-1-2

Technical data:

Nominal voltage:	U _o /U 0,6/1 kV
Test voltage:	4 kV
Temperature range	
<i>Fixed laying:</i>	- 40°C up to + 80°C
<i>Flexible installation:</i>	- 5°C up to + 70°C
Min. bending radius	
<i>Fixed laying:</i>	6 x d
<i>Flexible installation:</i>	20 x d

Features:

UV resistance
RoHS and CE approval



CONTROL AND CONNECTION CABLES

GAALFLEX® CONTROL 1000 CH

Halogen free control cable with overall copper screen, 0,6/1 kV



ELETTROTEK KABEL® GAALFLEX® CONTROL 1000 CH

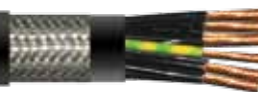

Part no.	No. of cores x cross section n x mm ²	Outer-Ø ca. mm ± 10%	Copper weight kg/km	Cable weight approx. kg/km	AWG no. *)
31300G71020M05	2 x 0,5	8,6	32	108	20
31300G70031M05	3 G 0,5	9	41,3	124	20
31300G70041M05	4 G 0,5	9,5	46,1	138	20
31300G70051M05	5 G 0,5	10,1	55,4	161	20
31300G70071M05	7 G 0,5	10,8	65	181	20
31300G70121M05	12 G 0,5	13,7	113,4	298	20
31300G70181M05	18 G 0,5	15,8	150,1	401	20
31300G70251M05	25 G 0,5	18	199,7	520	20
31300G71020M07	2 x 0,75	9	41,3	124	19
31300G70031M07	3 G 0,75	9,4	48,6	137	19
31300G70041M07	4 G 0,75	10	55,8	156	19
31300G70051M07	5 G 0,75	10,7	67,4	184	19
31300G70071M07	7 G 0,75	11,4	86,3	213	19
31300G70121M07	12 G 0,75	14,7	150,2	358	19
31300G70181M07	18 G 0,75	16,9	201,3	481	19
31300G70251M07	25 G 0,75	19,6	267,8	639	19
31300G71020M10	2 x 1	9,3	46,1	133	18
31300G70031M10	3 G 1	9,7	55,8	148	18
31300G70041M10	4 G 1	10,3	69,8	174	18
31300G70051M10	5 G 1	11,1	79,4	202	18
31300G70071M10	7 G 1	11,8	103	235	18
31300G70121M10	12 G 1	15,4	179	402	18
31300G70181M10	18 G 1	17,9	252,6	561	18
31300G70251M10	25 G 1	20,6	327,7	727	18
31300G71020M15	2 x 1,5	10,3	60,2	167	16
31300G70031M15	3 G 1,5	10,8	74,6	189	16
31300G70041M15	4 G 1,5	11,5	93,4	223	16
31300G70051M15	5 G 1,5	12,6	112,4	271	16
31300G70071M15	7 G 1,5	13,9	156,6	336	16
31300G70121M15	12 G 1,5	17,8	244,5	544	16
31300G70181M15	18 G 1,5	20,9	346,9	769	16
31300G70251M15	25 G 1,5	23,9	463,7	1001	16
31300G70031M25	3 G 2,5	12,2	107,9	250	14
31300G70041M25	4 G 2,5	13,5	151,9	323	14
31300G70051M25	5 G 2,5	14,8	183,8	395	14
31300G70071M25	7 G 2,5	15,9	231,8	460	14
31300G70121M25	12 G 2,5	20,8	375,7	775	14
31300G70181M25	18 G 2,5	24,5	543,7	1111	14
31300G70251M25	25 G 2,5	28,2	727,6	1458	14
31300G70031M40	3 G 4	14	171	350	12
31300G70041M40	4 G 4	15,3	217,4	432	12
31300G70051M40	5 G 4	16,7	263,8	525	12
31300G70031M60	3 G 6	15,4	236,6	446	10
31300G70041M60	4 G 6	16,8	302,2	551	10
31300G70051M60	5 G 6	18,6	367,7	681	10
31300G70041M61	4 G 10	20,9	471,7	856	8
31300G70051M61	5 G 10	23	583,6	1061	8
31300G70041M62	4 G 16	23,7	718,1	1187	6
31300G70051M62	5 G 16	26,4	887,6	1489	6

Other dimension and colours available on request.

CONTROL AND CONNECTION CABLES

GAALFLEX® CONTROL 1000 P

PUR/PUR control cable, 300/500 V and 0,6/1 kV



ELETTROTEK KABEL® GAALFLEX® CONTROL 1000 P



Construction:

- Conductor:** flexible red copper conductor Cl.5, acc. to IEC 60228
- Insulation:** PUR compound
- Colour cores:** acc. to DIN VDE 0293-308, HD 308 S2 from 6 cores black cores with consecutive numbers acc. to EN 50334; green-yellow earth-wire from 3 cores
- Outer Sheath:** orange (RAL 2004), PUR compound (other color on request)

Resistance:



Fire performance acc. to:
SEV TP 20B/3 C



Halogen-free acc. to:
DIN VDE 0482, part 267
EN 50267-2-1
IEC 60754-1



Corrosiveness of conflagration gases acc. to:
DIN VDE 0482 part 267
EN 50267-2-2
IEC 60754-2



Oil resistance acc. to:
DIN VDE 0473 part 811-2-1
IEC EN 60811-2-1,
SEV TP 20 B/3 C (72 h / 70 °C)

Technical data:

Nominal voltage:

≤ 1 mmq 300 / 500 V

≥ 1,5 mmq 0,6/1 kV

Test voltage:

≤ 1 mmq 2 kV

≥ 1,5 mmq 3,5 kV

Temperature range:

Fixed installation: -55°C up to +90°C

Flexible application: -40°C up to +80°C

Max. cond. temperature: +120°

Min. bending radius

Fixed laying: 4 x d

Flexible installation: 6 x d

Features:

abrasion resistant

weather resistant

very flexible at low temperature

acc. to SEV TP 20B/3 C standard

on request:
acc. to DIN VDE 0482 part 265-5-2 / EN 50266-5-2 / IEC 60332-3-24
identified with "5" on the 5th number of the Part. no

RoHS and CE approval



Part no.	No. of cores x cross section n x mm ²	Outer-Ø ca. mm ± 10%	Copper weight kg/km	Cable weight approx. kg/km	AWG no. *)
31280GGL010M65	1x 50	16,5	480	615	1
31280GGL010M66	1 x 70	17,4	672	860	2/0
31280GGL010M67	1 x 95	20,5	912	1010	3/0
31280GGL010M68	1x120	23	1152	1300	4/0
31280GGL010M69	1x150	25,5	1140	1600	250
31280GGL010M70	1 x 185	28	1776	1930	350
31280GGL010M71	1 x 240	31	2304	2525	450
31280GGP011M65	1G 50	16,5	480	615	1
31280GGP011M66	1 G 70	17,4	672	830	2/0
31280GGP011M67	1 G 95	20,5	912	1010	3/0
31280GGP011M68	1G120	23	1152	1300	4/0
31280GGP011M69	1 G 150	25,5	1140	1600	250
31280GGP011M70	1 G 185	28	1776	1930	350
31280GGP011M71	1 G 240	31	2304	2525	450

CONTROL AND CONNECTION CABLES

GAALFLEX® CONTROL 1000 P

PUR control cable, 300/500 V or 0,6/1 kV



ELETTROTEK KABEL® GAALFLEX® CONTROL 1000 P



Part no.	No. of cores x cross section n x mm ²	Outer-Ø ca. mm ± 10%	Copper weight kg/km	Cable weight approx. kg/km	AWG no. *)
31280DG3020M07	2 x 0,75	6,6	14,4	45	19
31280DG2031M07	3 G 0,75	7	21,6	57	19
31280DG2041M07	4 G 0,75	7,9	28,8	75	19
31280DG2051M07	5 G 0,75	8,4	36	87	19
31280DG3020M10	2 x 1	7,2	19,2	60	18
31280DG2031M07	3 G 1	7,7	28,8	75	18
31280DG2041M07	4 G 1	8,2	38,4	90	18
31280DG2051M07	5 G 1	9,3	48	110	18
31280DG0071M10	7 G 1	11,5	67,2	150	18
31280DG0121M10	12 G 1	13,7	115,2	221	18
31280DG0161M10	16 G 1	15,4	153,6	293	18
31280GG3020M15	2 x 1,5	7,8	28,8	80	16
31280GG2031M15	3 G 1,5	8,4	43,2	95	16
31280GG2041M15	4 G 1,5	9,2	57,6	120	16
31280GG2051M15	5 G 1,5	10,5	72	140	16
31280GG0071M15	7 G 1,5	12,3	100,8	200	16
31280GG0081M15	8 G 1,5	13,5	115,2	230	16
31280GG0101M15	10 G 1,5	14,7	144	320	16
31280GG0121M15	12 G 1,5	14,9	172,8	380	16
31280GG0141M15	14 G 1,5	15,3	201,6	410	16
31280GG0161M15	16 G 1,5	16,4	230,4	460	16
31280GG0201M15	20 G 1,5	21,3	288	523	16
31280GG0301M15	30 G 1,5	23,9	432	750	16
31280GG3020M25	2 x 2,5	9,3	48	105	14
31280GG2031M25	3 G 2,5	9,8	72	130	14
31280GG2041M25	4 G 2,5	10,7	96	170	14
31280GG2051M25	5 G 2,5	11,9	120	210	14
31280GG0071M25	7 G 2,5	14,8	168	290	14
31280GG0121M25	12 G 2,5	18,4	288	480	14
31280GG3020M40	2 x 4	12,5	76,8	180	12
31280GG2031M40	3 G 4	13,3	115,2	215	12
31280GG2041M40	4 G 4	14,9	153,6	275	12
31280GG2051M40	5 G 4	16,2	192	330	12
31280GG0071M40	7 G 4	17,2	268,8	450	12
31280GG3020M60	2 x 6	14,5	115,2	250	10
31280GG2031M60	3 G 6	15,3	172,8	310	10
31280GG2041M60	4 G 6	16,2	230,4	420	10
31280GG2051M60	5 G 6	18,4	288	200	10
31280GG0071M60	7 G 6	23,3	403,2	690	10
31280GG2041M61	4 G 10	21,3	384	690	8
31280GG2051M61	5 G 10	23,9	480	850	8
31280GG0071M61	7 G 10	27,4	672	1058	8
31280GG2031M62	3 G 16	22,7	460,8	750	6
31280GG2041M62	4 G 16	25,5	614,4	930	6
31280GG2051M62	5 G 16	27,2	768	1170	6
31280GG2031M63	3 G 25	26,8	720	1080	4
31280GG2041M63	4 G 25	29,4	960	1350	4
31280GG2051M63	5 G 25	32,3	1002	1690	4
31280GG2041M63	4 G 35	33,7	1344	1830	2
31280GG2051M63	5 G 35	37,8	1680	2280	2
31280GG2041M64	4 G 50	39,3	1920	2590	1
31280GG2051M64	5 G 50	43,8	2004	3220	1
31280GG2041M65	4 G 70	43,2	2688	3630	2/0
31280GG2051M65	5 G 70	49	3360	4520	2/0
31280GG2041M66	4 G 95	47,3	3648	4760	3/0
31280GG2051M66	5 G 95	52,8	4560	5910	3/0

Other dimension and colours available on request.

CONTROL AND CONNECTION CABLES

GAALFLEX® CONTROL H05BQ-F

PUR power cable, multi core, 300/500V

HAR

ELETTROTEK KABEL® GAALFLEX® H05BQ-F



Construction:

Conductor:	flexible red copper conductor Cl. 5, acc to IEC 60228, DIN VDE 0295
Insulation:	rubber compound
Colour cores:	acc. to DIN VDE 0293-308, HD 308 S2 from 6 cores black cores with consecutive numbers acc. to EN 50334; green-yellow earth-wire from 3 cores
Stranding:	in layers
Outer sheath:	orange (RAL 2003), PUR compound

Features:

chemical resistant
Uv resistant
abrasion resistant
acc. to standard HD 22.10.S1 and DIN VDE 0282 T10
acc. to HAR HD 22.10.S1
RoHS and CE approval



Technical data:

Nominal voltage:	300/500 V
Test voltage:	2 kV
Temperature range	
<i>Fixed laying:</i>	-40 up to +90°C
<i>Flexible installation:</i>	-40 up to +90°C
Min. bending radius	4 x d

Applications:

connecting cable used in hand-held electric tools. for flexible and fixed installation. Suitable in dry, humid or wet rooms. Outdoor use within temperature range. no laying underground

Part no.	No. of cores x cross section n x mm ²	Outer-Ø ca. mm ± 10%	Copper weight kg/km	Cable weight approx. kg/km	AWG no. *)
31310DG3020M10	2 x 1	7,2	19,2	65	18
31310DG2031M10	3 G 1	7,6	28,8	80	18
31310DG2041M10	4 G 1	8,3	38,4	90	18
31310DG2051M10	5 G 1	9,3	48	110	18
31310DG2071M10	7 G 1	10,2	67,2	140	18

Other dimension and colours available on request.

CONTROL AND CONNECTION CABLES

GAALFLEX® CONTROL 07BQ-F

PUR power cable, single core, 450/750 V

GAALFLEX® CONTROL 07BQ-F

Construction:

Conductor:	flexible red copper conductor Cl. 5, acc to IEC 60228, DIN VDE 0295
Insulation:	rubber compound
Colour cores:	L: (black), or PE: (green/yellow)
Stranding:	in layers
Outer sheath:	orange (RAL 2003), PUR compound

Features:

chemical resistant
Uv resistant
abrasion resistant
RoHS and CE approval



Technical data:

Nominal voltage:	450/750 V
Test voltage:	2,5 kV
Temperature range	
<i>Fixed laying:</i>	-40 up to +90°C
<i>Flexible installation:</i>	-40 up to +90°C
Min. bending radius	10 x d

Applications:

connecting cable used in hand-held electric tools.
for flexible and fixed installation.
Suitable in dry, humid or wet rooms.
Outdoor use within temperature range.
no laying underground

07BQ-F Single core

Part no.	No. of cores x cross section n x mm ²	Outer-Ø ca. mm ± 10%	Copper weight kg/km	Cable weight approx. kg/km	AWG no. *)
31310EGL010M62	1 x 16	10,8	153,6	230	6
31310EGL010M63	1 x 25	12,8	240	350	4
31310EGL010M64	1 x 35	15,3	336	484	2
31310EGL010M65	1 x 50	16,8	480	620	1
31310EGL010M66	1 x 70	19,0	672	830	2/0
31310EGL010M67	1 x 95	21,8	912	1130	3/0
31310EGL010M68	1 x 120	24,3	1152	1390	4/0
31310EGL010M69	1 x 150	26,6	1440	1710	250 MCM
31310EGL010M70	1 x 185	29,2	1776	2130	350 MCM
31310EGL010M71	1 x 240	33	2304	2720	450 MCM
31310EGL010M72	1 x 300	35	2880	3140	550 MCM

Other dimension and colours available on request.

CONTROL AND CONNECTION CABLES

GAALFLEX® CONTROL (H)07BQ-F

PUR power cable, multi core, 450/750 V

HAR

GAALFLEX® CONTROL H07BQ-F



Construction:

Conductor:	flexible red copper conductor Cl. 5, acc to IEC 60228, DIN VDE 0295
Insulation:	rubber compound
Colour cores:	acc. to DIN VDE 0293-308, HD 308 S2 from 6 cores black cores with consecutive numbers acc. to EN 50334; green-yellow earth-wire from 3 cores
Stranding:	in layers
Outer sheath:	orange (RAL 2003), PUR compound

Features:

chemical resistant
Uv resistant
abrasion resistant
acc. to standard HD 22.10.S1 and DIN VDE 0282 T10
acc. to HAR HD 22.10.S1
RoHS and CE approval



Technical data:

Nominal voltage:	450/750 V
Test voltage:	2,5 kV
Temperature range	
<i>Fixed laying:</i>	-40 up to +90°C
<i>Flexible installation:</i>	-40 up to +90°C
Min. bending radius	4 x d

Applications:

connecting cable used in hand-held electric tools. for flexible and fixed installation. Suitable in dry, humid or wet rooms. Outdoor use within temperature range. no laying underground

H07BQ-F

Part no.	No. of cores x cross section n x mm ²	Outer-Ø ca. mm ± 10%	Copper weight kg/km	Cable weight approx. kg/km	AWG no. *)
31310EG3020M15	2 x 1,5	8,8	28,8	115	16
31310EG2031M15	3 G 1,5	9,3	43,2	135	16
31310EG2041M15	4 G 1,5	10,5	57,6	165	16
31310EG2051M15	5 G 1,5	11,5	72	200	16
31310EG2031M25	3 G 2,5	11,2	72	190	14
31310EG2041M25	4 G 2,5	12,5	96	230	14
31310EG2051M25	5 G 2,5	13,8	120	290	14
31310EG2041M40	4 G 4	14,7	153,6	325	12
31310EG2051M40	5 G 4	16,2	192	400	12
31310EG2041M60	4 G 6	16,4	230,4	350	10
31310EG2051M60	5 G 6	18,1	288	520	10
31310EG2041M61	4 G 10	21,3	384	730	8
31310EG2051M61	5 G 10	23,4	480	900	8
31310EG3020M62	2 x 16	20,4	307,2	600	6
31310EG2041M62	4 G 16	24,4	614,4	1020	6
31310EG2051M62	5 G 16	27,2	768	1260	6

07BQ-F Multi cores

Part no.	No. of cores x cross section n x mm ²	Outer-Ø ca. mm ± 10%	Copper weight kg/km	Cable weight approx. kg/km	AWG no. *)
31310EG2041M63	4 G 25	29,8	960	1240	4
31310EG2051M63	5 G 25	35,3	1200	1550	4
31310EG2041M64	4 G 35	33,7	1344	1680	2
31310EG2051M64	5 G 35	39,3	1680	2120	2
31310EG2041M65	4 G 50	39,7	1920	2360	1
31310EG2051M65	5 G 50	47,2	2400	2980	1
31310EG2041M66	4 G 70	49,3	2688	3280	2/0
31310EG2051M66	5 G 70	53,3	3360	4020	2/0
31310EG2051M67	5 G 95	60,4	4560	5390	3/0

Other dimension and colours available on request.

CONTROL AND CONNECTION CABLES

GAALFLEX® CONTROL H07ZZ-F

Halogen-free power cable, multi core, 450/750 V

HAR



ELETTROTEK KABEL® GAALFLEX CONTROL H07ZZ-F

Construction:

- Conductor:** flexible red copper conductor Cl. 5, acc to IEC 60228, DIN VDE 0295
- Insulation:** halogen-free type EI8
- Colour cores:** acc. to DIN VDE 0293-308, HD 308 S2 from 6 cores black cores with consecutive numbers acc. to EN 50334; green-yellow earth-wire from 3 cores
- Outer sheath:** black (similar to RAL 9005), halogen-free type EM8

Resistance:



Self-extinguishing and flame retardant acc. to:

DIN VDE 0482 part 265-2-1
EN 50265-2-1
IEC 60332-1-2,
DIN VDE 0482 part 265-5-2
EN 50265-5-2
IEC 60332-3-24



Halogen-free acc. to:

DIN VDE 0482, part 267
EN 50267-2-1
IEC 60754-1



Corrosiveness of conflagration gases acc. to:

DIN VDE 0482 part 267
EN 50267-2-2
IEC 60754-2



Smoke density acc. to:

IEC 61034-1-2

Technical data:

- Nominal voltage:** 450/750 V
- Test voltage:** 2,5 kV
- Temperature range** -20 up to +90°C
- Max. short circuit temperature:** + 250°C
- Min. bending radius** D<8 D<12 D<20 D>20
- Fixed laying:** 3xD 3xD 4xD 4xD
- Flexible installation:** 4xD 4xD 5xD 6xD
- Tensile strength:** 15 N/mm²

Features:

- flexible
- 0,6/1 kV version on request
- <HAR>
- RoHS and CE approval



Part no.	No. of cores x cross section n x mm ²	Outer-Ø ca. mm ± 10%	Copper weight kg/km	Cable weight approx. kg/km	AWG no. *)
31560E7L010M15	1x1,5	6,4	14	50	16
31560E7L010M25	1x2,5	7,1	24	65	14
31560E7L010M40	1x4	8,1	38	89	12
31560E7L010M60	1x6	8,8	58	115	10
31560E7L010M61	1x10	11	96	190	8
31560E7L010M62	1x16	12,1	154	259	6
31560E7L010M63	1x25	14,2	240	375	4
31560E7L010M64	1x35	16,1	336	492	2
31560E7L010M65	1x50	18,5	480	675	1
31560E7L010M66	1x70	21	672	908	2/0
31560E7L010M67	1x95	23,5	912	1171	3/0
31560E7L010M68	1x120	25,8	1152	1445	4/0
31560E7L010M69	1x150	28,2	1440	1783	250 MCM
31560E7L010M70	1x185	31	1776	2125	350 MCM
31560E7L010M71	1x240	34,5	2304	2733	450 MCM
31560E7L010M72	1x300	37,5	2880	3348	550 MCM
31560E7L010M73	1x400	42	3840	4200	750 MCM
31560E7L010M74	1x500	47	4800	5500	1000 MCM

CONTROL AND CONNECTION CABLES

GAALFLEX® CONTROL H07ZZ-F

Halogen-free power cable, multi core, 450/750 V

HAR



Part no.	No. of cores x cross section n x mm ²	Outer-Ø ca. mm ± 10%	Copper weight kg/km	Cable weight approx. kg/km	AWG no. *)
31560E73020M10	2x1	9	19	90	18
31560E73020M15	2x1,5	10	29	109	16
31560E73020M25	2x2,5	11,5	48	158	14
31560E73020M40	2x4	13,5	77	217	12
31560E73020M60	2x6	15	115	282	10
31560E73020M61	2x10	20,5	192	539	8
31560E73020M62	2x16	22,5	307	722	6
31560E73020M63	2x25	27,3	480	1043	4
31560E72031M10	3G1	9,4	29	110	18
31560E72031M15	3G1,5	10,5	43	134	16
31560E72031M25	3G2,5	12,5	72	196	14
31560E72031M40	3G4	14,5	115	271	12
31560E72031M40	3G6	16	173	355	10
31560E72031M61	3G10	21,5	288	674	8
31560E72031M62	3G16	24,8	461	913	6
31560E72031M63	3G25	29,5	720	1324	4
31560E72031M64	3G35	33	1008	1754	2
31560E72031M65	3G50	38,5	1440	2409	1
31560E72031M66	3G70	43,5	2016	3211	2/0
31560E72031M67	3G95	49	2736	4210	3/0
31560E72031M68	3G120	53,5	3456	5205	4/0
31560E72031M69	3G150	59	4320	6389	250 MCM
31560E72031M70	3G185	54,5	5328	7591	350 MCM
31560E72031M71	3G240	73,5	6192	9944	450 MCM
31560E72031M72	3G300	81	8640	11545	550 MCM
31560E72041M10	4G1	10,2	38	136	18
31560E72041M15	4G1,5	11,5	58	166	16
31560E72041M25	4G2,5	13,5	96	241	14
31560E72041M40	4G4	16	154	336	12
31560E72041M60	4G6	18	230	449	10
31560E72041M61	4G10	23,5	384	833	8
31560E72041M62	4G16	27	614	1138	6
31560E72041M63	4G25	32,5	960	1714	4
31560E72041M64	4G35	37	1334	2204	2
31560E72041M65	4G50	42,5	1920	3029	1
31560E72041M66	4G70	48	2688	4121	2/0
31560E72041M67	4G95	53	3638	5361	3/0
31560E72041M68	4G120	60	4608	6546	4/0
31560E72041M69	4G150	66	5760	8095	250 MCM
31560E72041M70	4G185	72	7104	9652	350 MCM
31560E72041M71	4G240	82	9216	12614	450 MCM
31560E72041M72	4G300	90	11520	17045	550 MCM
31560E72051M10	5G1	11,5	48	168	18
31560E72051M15	5G1,5	12,5	72	206	16
31560E72051M25	5G2,5	15,5	120	297	14
31560E72051M40	5G4	17,5	192	422	12
31560E72051M60	5G6	20	288	567	10
31560E72051M61	5G10	26	480	1010	8
31560E72051M62	5G16	30	768	1400	6
31560E72051M63	5G25	36	1200	2096	4
31560E70071M15	7G1,5	15,5	101	315	16
31560E70071M25	7G2,5	18	268,8	445	14
31560E70071M40	7G4	20,5	168	618	12
31560E70101M15	10G1,5	18	144	420	16
31560E70121M25	12G1,5	20	175	493	16
31560E70121M25	12G2,5	23	288	702	14
31560E70121M40	12G4	28	460	1004	12
31560E70191M15	19G1,5	23,5	274	710	16
31560E70191M25	19G2,5	27,5	456	1030	14
31560E70241M15	24G1,5	27,5	346	898	16
31560E70241M25	24G2,5	33	576	1312	14
31560E70361M15	36G1,5	32	518	1246	16
31560E70361M25	36G2,5	37,5	864	1851	14

Other dimension and colours available on request.

CONTROL AND CONNECTION CABLES

GAALFLEX® CONTROL 600

PVC control cable, 450/750 V UL 600 V



ELETTROTEK KABEL® GAALFLEX® CONTROL 600

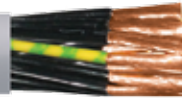

Construction:

Conductor:	flexible red copper conductor Cl.5, acc.to IEC 60228, DIN VDE 0295
Insulation:	PVC type T11 class 43 acc. to UL 1581
Colour cores:	black cores with consecutive numbers acc. to EN 50334, green-yellow from 3 cores
Stranding:	in layers
Outer sheath:	grey (RAL 7001) PVC type TM5, acc.to DIN VDE 0281 part 1 + HD 21.1 and class 43 acc. to UL 1581

Resistance:



Self-extinguishing and flame retardant acc. to:

DIN VDE 0482 part 265-2-1
EN 50265-2-1
IEC 60332-1-2,
DIN VDE 0482 part 265-2-5
EN 50265-2-5
IEC 60332-3C
UL VW-1, CSA FT1 FT2



Oil resistance:

acc. to DIN EN 50290-2-22 resp. VDE 0819-102, TM54

Technical data:

Nominal voltage:	DIN VDE UoU 450/750 V UL/CSA 600V
Test voltage:	3 kV acc.to DIN VDE 0281 part 2 + HD 21.2
Temperature range	DIN VDE UL/CSA
<i>Fixed laying:</i>	-40°C up to +70°C up to +90°C
<i>Flexible installation:</i>	+5°C up to +70°C up to +90°C
Min. bending radius	7,5 x d

Features:

small bending radius
on request black
UL recognized AWM style 2587 90°C 600 V or style 21179 105°C 600 V,
on request style 21216 90°C Oil 60°C 600V
CSA AWM I/II A/B 90°C 600 V FT1 FT2 CE

RoHS and CE approval



Part no.	No.of cores x cross section n x mm ²	Outer-Ø ca.mm ± 10%	Copper weight kg/km	Cable weight approx. kg/km	AWG no.*)
31150F51020A20	2 x 0,5	5,8	9,6	45,4	20
31150F50031A20	3 G 0,5	6,2	14,4	54,4	20
31150F50041A20	4 G 0,5	6,7	19,2	65,3	20
31150F50051A20	5 G 0,5	7,3	24	78,5	20
31150F50061A20	6 G 0,5	8	28,8	94,4	20
31150F50071A20	7 G 0,5	8	33,6	97,8	20
31150F50081A20	8 G 0,5	9,3	38,4	127,5	20
31150F50091A20	9 G 0,5	10	43,2	142	20
31150F50101A20	10 G 0,5	10,2	48	150,1	20
31150F50121A20	12 G 0,5	10,5	57,6	164	20
31150F50141A20	14 G 0,5	11	67,2	183,2	20
31150F50161A20	16 G 0,5	11,6	76,8	205,6	20
31150F50181A20	18 G 0,5	12,6	86,4	234,6	20
31150F50191A20	19 G 0,5	12,6	91,2	238	20
31150F50211A20	21G 0,5	13,7	100,8	277,6	20
31150F50251A20	25 G 0,5	14,6	120	313,7	20
31150F50271A20	27 G 0,5	15,4	129,6	347,5	20
31150F50301A20	30 G 0,5	15,7	144	368,3	20
31150F50321A20	32 G 0,5	16,1	153,6	389,5	20
31150F50341A20	34 G 0,5	17,2	163,2	418,5	20
31150F50351A20	35 G 0,5	17,2	168	433,4	20
31150F50371A20	37 G 0,5	17,2	177,6	440,2	20
31150F50401A20	40 G 0,5	18,2	192	490,1	20
31150F50411A20	41 G 0,5	18,7	196,8	505,8	20
31150F50421A20	42 G 0,5	18,7	201,6	509,3	20
31150F50501A20	50 G 0,5	20,3	240	606	20
31150F50561A20	56 G 0,5	21,9	268,8	748,1	20
31150F50611A20	61 G 0,5	22,2	292,8	780,7	20

CONTROL AND CONNECTION CABLES

GAALFLEX® CONTROL 600

PVC control cable, 450/750 V UL 600 V



ELETTROTEK KABEL® GAALFLEX® CONTROL 600



Part no.	No. of cores x cross section n x mm ²	Outer-Ø ca. mm ± 10%	Copper weight kg/km	Cable weight approx. kg/km	AWG no. *)
31150F51020A19	2 x 0,75	6,2	14,4	54,4	19
31150F50031A19	3 G 0,75	6,6	21,6	65,5	19
31150F50041A19	4 G 0,75	7,2	28,8	80,2	19
31150F50051A19	5 G 0,75	7,9	36	97,7	19
31150F50061A19	6 G 0,75	8,6	43,2	116,3	19
31150F50071A19	7 G 0,75	8,6	50,4	121,4	19
31150F50081A19	8 G 0,75	10,2	57,6	156,9	19
31150F50091A19	9 G 0,75	10,8	64,8	176,5	19
31150F50101A19	10 G 0,75	11	72	186,6	19
31150F50121A19	12 G 0,75	11,3	86,4	204,6	19
31150F50141A19	14 G 0,75	12,1	100,8	230,8	19
31150F50151A19	15 G 0,75	12,5	108	247,1	19
31150F50161A19	16 G 0,75	12,7	115,2	257,9	19
31150F50181A19	18 G 0,75	13,5	129,6	292	19
31150F50191A19	19 G 0,75	13,5	136,8	297,1	19
31150F50211A19	21 G 0,75	15	151,2	349,2	19
31150F50241A19	24 G 0,75	15,7	172,8	388,8	19
31150F50251A19	25 G 0,75	15,8	180	397,5	19
31150F50261A19	26 G 0,75	16,2	187,2	417,1	19
31150F50271A19	27 G 0,75	16,9	194,4	440,8	19
31150F50301A19	30 G 0,75	17,2	216	467,6	19
31150F50321A19	32 G 0,75	17,6	230,4	493,4	19
31150F50341A19	34 G 0,75	18,8	244,8	531,8	19
31150F50361A19	36 x 0,75	18,8	259,2	554,5	19
31150F50371A19	37 x 0,75	18,8	266,4	559,6	19
31150F50421A19	42 x 0,75	20,2	302,4	646	19
31150F50451A19	45 x 0,75	22	324	792,6	19
31150F50501A19	50 x 0,75	22,5	360	844,3	19
31150F50611A19	61 G 0,75	24	439,2	982,3	19
31150F51020A18	2 x 1	6,5	19,2	62,2	18
31150F50031A18	3 G 1	6,9	28,8	75,3	18
31150F50041A18	4 G 1	7,5	38,4	92,2	18
31150F50051A18	5 G 1	8,3	48,0	113,8	18
31150F50061A18	6 G 1	9	57,6	134,7	18
31150F50071A18	7 G 1	9	67,2	141,6	18
31150F50081A18	8 G 1	10,8	76,8	185,1	18
31150F50091A18	9 G 1	11,3	86,4	204,6	18
31150F50101A18	10 G 1	11,6	96,0	219,3	18
31150F50121A18	12 G 1	12,2	115,2	243,9	18
31150F50141A18	14 G 1	12,8	134,4	274,5	18
31150F50161A18	16 G 1	13,4	153,6	306	18
31150F50181A18	18 G 1	15,3	172,8	348,1	18
31150F50191A18	19 G 1	14,5	182,4	354,9	18
31150F50201A18	20 G 1	15,3	192	388,5	18
31150F50211A18	21 G 1	15,9	201,6	416,5	18
31150F50241A18	24 G 1	16,8	230,4	462,7	18
31150F50251A18	25 G 1	16,8	240	469,5	18
31150F50261A18	26 G 1	17,3	249,6	495,4	18
31150F50271A18	27 G 1	17,8	259,2	521,9	18
31150F50301A18	30 G 1	18,2	288	558,5	18
31150F50321A18	32 G 1	18,8	307,2	588,7	18
31150F50341A18	34 G 1	19,9	326,4	632,2	18
31150F50361A18	36 G 1	19,9	345,6	663,4	18
31150F50371A18	37 G 1	19,9	355,2	670,2	18
31150F50411A18	41 G 1	22	393,6	842,2	18
31150F50421A18	42 G 1	22	403,2	849	18
31150F50501A18	50 G 1	23,8	480	1000,2	18
31150F50561A18	56 G 1	25	537,6	1109,7	18
31150F50611A18	61 G 1	25,3	585,6	1161,6	18

CONTROL AND CONNECTION CABLES

GAALFLEX® CONTROL 600

PVC control cable, 450/750 V UL 600 V



ELETTROTEK KABEL® GAALFLEX® CONTROL 600

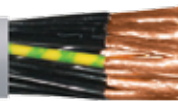

Part no.	No. of cores x cross section n x mm ²	Outer-Ø ca. mm ± 10%	Copper weight kg/km	Cable weight approx. kg/km	AWG no. *)
31150F51020A16	2 x 1,5	7,1	28,8	85,8	16
31150F50031A16	3 G 1,5	7,5	43,2	105,3	16
31150F50041A16	4 G 1,5	8,2	57,6	129,4	16
31150F50051A16	5 G 1,5	9,1	72	159	16
31150F50061A16	6 G 1,5	10,1	86,4	190,6	16
31150F50071A16	7 G 1,5	10,1	100,8	201,1	16
31150F50081A16	8 G 1,5	12	115,2	259,5	16
31150F50091A16	9 G 1,5	12,7	129,6	290,7	16
31150F50101A16	10 G 1,5	12,9	144	310,4	16
31150F50111A16	11 G 1,5	13	158,4	324	16
31150F50121A16	12 G 1,5	13,4	172,8	347,2	16
31150F50141A16	14 G 1,5	14,2	201,6	391,3	16
31150F50161A16	16 G 1,5	15	230,4	440,2	16
31150F50181A16	18 G 1,5	15,9	259,2	498,1	16
31150F50191A16	19 G 1,5	15,9	273,6	508,6	16
31150F50201A16	20 G 1,5	17,1	288	558,4	16
31150F50211A16	21 G 1,5	17,7	302,4	597,9	16
31150F50241A16	24 G 1,5	18,7	345,6	668,2	16
31150F50251A16	25 G 1,5	18,8	360	678,7	16
31150F50261A16	26 G 1,5	19,3	374,4	788,4	16
31150F50271A16	27 G 1,5	19,8	388,8	828,9	16
31150F50301A16	30 G 1,5	20,2	432	880,7	16
31150F50321A16	32 G 1,5	21,3	460,8	927,8	16
31150F50341A16	34 G 1,5	22,5	489,6	997,2	16
31150F50371A16	37 G 1,5	22,5	532,8	1050,8	16
31150F50411A16	41 G 1,5	24,2	590,4	1197,1	16
31150F50421A16	42 G 1,5	24,2	604,8	1207,6	16
31150F50501A16	50 G 1,5	26,2	720	1429,3	16
31150F50561A16	56 G 1,5	27,8	806,4	1657,1	16
31150F50611A16	61 G 1,5	28,2	878,4	1745,2	16
31150F51020A14	2 x 2,5	8,1	48	99,8	14
31150F50031A14	3 G 2,5	8,6	72	126,3	14
31150F50041A14	4 G 2,5	9,4	96	157,5	14
31150F50051A14	5 G 2,5	10,6	120	194,2	14
31150F50071A14	7 G 2,5	11,6	168	250,3	14
31150F50081A14	8 G 2,5	13,8	192	315,8	14
31150F50091A14	9 G 2,5	14,8	216	354	14
31150F50101A14	10 G 2,5	15,1	240	380,7	14
31150F50121A14	12 G 2,5	15,6	288	431,5	14
31150F50141A14	14 G 2,5	16,6	336	489,7	14
31150F50161A14	16 G 2,5	17,5	384	552,6	14
31150F50181A14	18 G 2,5	18,8	432	624,6	14
31150F50241A14	24 G 2,5	22,2	576	836,8	14
31150F50251A14	25 G 2,5	22,2	600	854,3	14
31150F50341A14	34 G 2,5	26,0	816	1236,1	14
31150F51020A12	2 x 4	9,3	76,8	145,3	12
31150F50031A12	3 G 4	10,2	115,2	183,8	12
31150F50041A12	4 G 4	11,2	153,6	234,5	12
31150F50051A12	5 G 4	12,5	192	287,7	12
31150F50071A12	7 G 4	13,7	268,8	373,9	12
31150F50111A12	11 G 4	17,9	422,4	601,5	12
31150F50121A12	12 G 4	18,6	460,8	648,3	12
31150F51020A10	2 x 6	10,6	115,2	204,3	10
31150F50031A10	3 G 6	11,3	172,8	263,4	10
31150F50041A10	4 G 6	12,7	230,4	334,6	10
31150F50051A10	5 G 6	14,2	288	415	10
31150F50071A10	7 G 6	15,6	403,2	544,5	10
31150F51020A08	2 x 10	13,0	192	323,7	8
31150F50031A08	3 G 10	13,9	288	420,7	8
31150F50041A08	4 G 10	15,5	384	536,9	8
31150F50051A08	5 G 10	17,4	480	669,1	8
31150F50071A08	7 G 10	19,2	672	873,5	8

Other dimension and colours available on request.

CONTROL AND CONNECTION CABLES

GAALFLEX® CONTROL 600 CY Lean

PVC control cable with overall copper screen, 450/750V UL 600V



ELETTROTEK KABEL® GAALFLEX® CONTROL 600 CY Lean

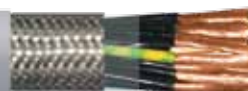

Construction:

Conductor:	flexible red copper conductor Cl.5, acc.to IEC 60228, DIN VDE 0295
Insulation:	PVC type T11 class 43 acc. to UL 1581
Colour cores:	black cores with consecutive numbers acc. to EN 50334, green-yellow from 3 cores
Stranding:	in layers
Wrapping	PETP foil
Screen:	tinned copper braid
Outer sheath:	grey (RAL 7001) PVC type TM5, acc.to DIN VDE 0281 part 1 + HD 21.1 and class 43 acc. to UL 1581

Resistance:



Self-extinguishing and flame retardant acc. to:
DIN VDE 0482 part 265-2-1
EN 50265-2-1
IEC 60332-1-2,
UL VW-1, CSA FT1 FT2



Oil resistance:
acc. to DIN EN 50290-2-22 resp. VDE 0819-102, TM54

Technical data:

Nominal voltage:	DIN VDE UoU 450/750 V UL/CSA 600V
Test voltage:	3 kV acc.to DIN VDE 0281 part 2 + HD 21.2
Temperature range	DIN VDE UL/CSA
<i>Fixed laying:</i>	-40°C up to +70°C up to +90°C
<i>Flexible installation:</i>	+5°C up to +70°C up to +90°C
Min. bending radius	7,5 x d

Features:

high mechanical loading capacity

UL recognized AWM style 2587 90°C 600 V or style 21179 105°C 600 V, on request style 21216 90°C Oil 60°C 600V CSA AWM I/II A/B 90°C 600 V FT1 FT2 CEE

RoHS and CE approval



Part no.	No.of cores x cross section n x mm ²	Outer-Ø ca.mm ± 10%	Copper weight kg/km	Cable weight approx. kg/km	AWG no.*)
31190F51020A20	2 x 0,5	6,4	27	59,2	20
31190F50031A20	3 G 0,5	6,8	32	67,6	20
31190F50041A20	4 G 0,5	7,3	41,6	84,2	20
31190F50051A20	5 G 0,5	7,9	46,9	98,1	20
31190F50061A20	6 G 0,5	8,6	56,7	117,1	20
31190F50071A20	7 G 0,5	8,6	61,5	120,5	20
31190F50081A20	8 G 0,5	10,1	70,9	157,4	20
31190F50091A20	9 G 0,5	10,6	80,4	179,2	20
31190F50101A20	10 G 0,5	10,8	85,2	169,4	20
31190F50121A20	12 G 0,5	11,1	94,8	188,7	20
31190F50141A20	14 G 0,5	11,6	104,4	209,5	20
31190F50161A20	16 G 0,5	12,4	118,6	241,9	20
31190F50181A20	18 G 0,5	13,4	132,9	270,8	20
31190F50191A20	19 G 0,5	13,4	137,7	274,2	20
31190F50211A20	21G 0,5	14,7	151,9	321,2	20
31190F50251A20	25 G 0,5	15,4	171,1	348,1	20
31190F50271A20	27 G 0,5	16,4	185,4	374,7	20
31190F50301A20	30 G 0,5	16,7	199,8	411,9	20
31190F50321A20	32 G 0,5	17,1	214	438	20
31190F50341A20	34 G 0,5	18	228,3	468,5	20
31190F50351A20	35 G 0,5	18	233,1	477,4	20
31190F50371A20	37 G 0,5	18	242,7	489,6	20
31190F50401A20	40 G 0,5	19,2	257,1	542,7	20
31190F50411A20	41 G 0,5	19,5	266,5	562,1	20
31190F50421A20	42 G 0,5	19,5	271,3	570,9	20
31190F50501A20	50 G 0,5	21,7	314,4	671,5	20
31190F50561A20	56 G 0,5	21,7	347,8	737,2	20
31190F50611A20	61 G 0,5	21,7	421,9	837,1	20

CONTROL AND CONNECTION CABLES

GAALFLEX® CONTROL 600 CY Lean

PVC control cable with overall copper screen, 450/750 V UL 600 V



ELETTROTEK KABEL® GAALFLEX® CONTROL 600 CY Lean

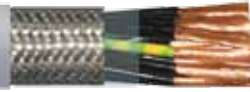

Part no.	No. of cores x cross section n x mm ²	Outer-Ø ca. mm ± 10%	Copper weight kg/km	Cable weight approx. kg/km	AWG no. *)
31190F51020A19	2 x 0,75	6,8	32	66,9	19
31190F50031A19	3 G 0,75	7,2	43,9	82,3	19
31190F50041A19	4 G 0,75	7,8	51,5	97,9	19
31190F50051A19	5 G 0,75	8,5	63,9	119,4	19
31190F50061A19	6 G 0,75	9,2	71,1	137	19
31190F50071A19	7 G 0,75	9,2	78,3	142,2	19
31190F50081A19	8 G 0,75	10,8	94,8	189,8	19
31190F50091A19	9 G 0,75	11,4	102	211,5	19
31190F50101A19	10 G 0,75	11,6	109,2	200,6	19
31190F50121A19	12 G 0,75	12,1	128,2	235,7	19
31190F50141A19	14 G 0,75	12,9	142,6	262,7	19
31190F50151A19	15 G 0,75	13,3	154,5	282,4	19
31190F50161A19	16 G 0,75	13,5	161,7	296	19
31190F50181A19	18 G 0,75	14,5	180,7	337,7	19
31190F50191A19	19 G 0,75	14,5	187,9	342,8	19
31190F50211A19	21 G 0,75	15,8	207	392,3	19
31190F50241A19	24 G 0,75	16,7	228,6	424,1	19
31190F50251A19	25 G 0,75	16,8	235,8	436	19
31190F50261A19	26 G 0,75	17,2	247,6	454,7	19
31190F50271A19	27 G 0,75	17,7	254,8	469	19
31190F50301A19	30 G 0,75	18	281,1	511,6	19
31190F50321A19	32 G 0,75	18,4	295,5	539,4	19
31190F50341A19	34 G 0,75	19,6	314,5	585,6	19
31190F50361A19	36 x 0,75	19,6	328,9	608,8	19
31190F50371A19	37 x 0,75	19,6	336,1	614	19
31190F50421A19	42 x 0,75	21,6	376,8	734,3	19
31190F50451A19	45 x 0,75	22,8	403	764,2	19
31190F50501A19	50 x 0,75	23,3	502	893,5	19
31190F50561A19	61 G 0,75	23,3	581,2	1032,7	19
31190F51020A18	2 x 1	7,1	37	73,7	18
31190F50031A18	3 G 1	7,5	51,3	91,4	18
31190F50041A18	4 G 1	8,1	61,4	110	18
31190F50051A18	5 G 1	8,9	75,9	134,2	18
31190F50061A18	6 G 1	9,8	90,1	164,5	18
31190F50071A18	7 G 1	9,8	99,7	171,3	18
31190F50081A18	8 G 1	11,4	114	215	18
31190F50091A18	9 G 1	12,1	128,2	250,4	18
31190F50101A18	10 G 1	12,4	137,8	239,2	18
31190F50121A18	12 G 1	13	157	269,4	18
31190F50141A18	14 G1	13,6	180,9	306,7	18
31190F50161A18	16 G 1	14,4	200,1	347,4	18
31190F50181A18	18 G 1	15,3	223,9	388,8	18
31190F50191A18	19 G 1	15,3	233,5	395,7	18
31190F50201A18	20 G 1	16,1	247,8	432,6	18
31190F50211A18	21 G 1	16,9	262	465,1	18
31190F50241A18	24 G 1	17,6	290,8	495,3	18
31190F50251A18	25 G 1	17,6	300,4	509,7	18
31190F50261A18	26 G 1	18,1	314,7	531,1	18
31190F50271A18	27 G 1	18,8	324,3	548,4	18
31190F50301A18	30 G 1	19,2	353,1	603,2	18
31190F50321A18	32 G 1	19,6	376,9	641,1	18
31190F50341A18	34 G 1	21,3	400,8	714,3	18
31190F50361A18	36 G 1	21,3	420	742,7	18
31190F50371A18	37 G 1	21,3	429,6	749,5	18
31190F50411A18	41 G 1	22,8	472,6	843,8	18
31190F50421A18	42 G 1	22,8	482,2	858	18
31190F50501A18	50 G 1	24,6	622	1031,6	18
31190F50561A18	56 G 1	24,6	692,5	1138,8	18
31190F50611A18	61 G 1	24,6	740,5	1212,6	18

CONTROL AND CONNECTION CABLES

GAALFLEX® CONTROL 600 CY Lean

PVC control cable with overall copper screen, 450/750 V UL 600 V



ELETTROTEK KABEL® GAALFLEX® CONTROL 600 CY Lean

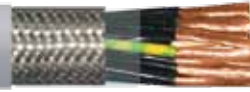

Part no.	No. of cores x cross section n x mm ²	Outer-Ø ca. mm ± 10%	Copper weight kg/km	Cable weight approx. kg/km	AWG no. *)
31190F51020A16	2 x 1,5	7,7	51,8	97,2	16
31190F50031A16	3 G 1,5	8,1	71,1	121	16
31190F50041A16	4 G 1,5	8,8	90,1	151,4	16
31190F50051A16	5 G 1,5	9,9	104,5	183,9	16
31190F50061A16	6 G 1,5	10,7	123,6	218,9	16
31190F50071A16	7 G 1,5	10,7	138	229,1	16
31190F50081A16	8 G 1,5	12,8	161,7	299,7	16
31190F50091A16	9 G 1,5	13,5	176,1	342,6	16
31190F50101A16	10 G 1,5	13,7	195,1	331,4	16
31190F50101A16	11 G 1,5	13,8	209,5	363,4	16
31190F50121A16	12 G 1,5	14,4	223,9	375,7	16
31190F50141A16	14 G 1,5	15	257,4	427,5	16
31190F50161A16	16 G 1,5	15,8	290,8	489,3	16
31190F50181A16	18 G 1,5	16,9	324,3	546,8	16
31190F50191A16	19 G 1,5	16,9	338,7	557	16
31190F50201A16	20 G 1,5	17,9	353,1	612,5	16
31190F50211A16	21 G 1,5	18,7	372,1	646	16
31190F50241A16	24 G 1,5	19,5	420	724,2	16
31190F50251A16	25 G 1,5	19,6	434,4	745,5	16
31190F50261A16	26 G 1,5	20,1	448,8	770,4	16
31190F50271A16	27 G 1,5	21,2	467,8	800,7	16
31190F50301A16	30 G 1,5	21,6	511	868,3	16
31190F50321A16	32 G 1,5	22,1	602,8	983,1	16
31190F50341A16	34 G 1,5	23,3	631,6	1040,4	16
31190F50371A16	37 G 1,5	23,3	674,8	1092,3	16
31190F50411A16	41 G 1,5	25	745,3	1233,1	16
31190F50421A16	42 G 1,5	25	759,7	1253,9	16
31190F50501A16	50 G 1,5	27	900,8	1503,8	16
31190F50561A16	56 G 1,5	27	987,2	1642,8	16
31190F50611A16	61 G 1,5	27	1.072,1	1764,6	16
31190F51020A14	2 x 2,5	8,7	75,9	123,3	14
31190F50031A14	3 G 2,5	9,2	99,9	150,6	14
31190F50041A14	4 G 2,5	10,2	128,5	199,2	14
31190F50051A14	5 G 2,5	11,2	157,2	238,7	14
31190F50071A14	7 G 2,5	12,4	209,8	306,9	14
31190F50081A14	8 G 2,5	14,8	243,1	394,6	14
31190F50091A14	9 G 2,5	15,6	271,8	447,8	14
31190F50101A14	10 G 2,5	15,9	295,8	433,2	14
31190F50121A14	12 G 2,5	16,6	343,8	495,9	14
31190F50141A14	14 G 2,5	17,4	396,4	574,6	14
31190F50161A14	16 G 2,5	18,3	449,1	648,7	14
31190F50181A14	18 G 2,5	19,6	501,7	735,2	14
31190F50241A14	24 G 2,5	23	655	960,6	14
31190F50251A14	25 G 2,5	23	729,1	1044,2	14
31190F50341A14	34 G 2,5	26,8	983,9	1393,9	14
31190F51020A12	2 x 4	10,1	109,3	171,2	12
31190F50031A12	3 G 4	10,8	152,4	218,0	12
31190F50041A12	4 G 4	11,8	195,4	280,8	12
31190F50051A12	5 G 4	13,3	238,5	343,8	12
31190F50071A12	7 G 4	14,7	319,9	443,4	12
31190F50111A12	11 G 4	18,9	487,5	696,9	12
31190F50121A12	12 G 4	19,4	530,5	732,1	12
31190F51020A10	2 x 6	11,2	152,4	221,1	10
31190F50031A10	3 G 6	12,1	214,6	291	10
31190F50041A10	4 G 6	13,5	276,9	376,3	10
31190F50051A10	5 G 6	15	339,1	461	10
31190F50071A10	7 G 6	16,6	459	590,9	10
31190F50031A08	3 G 10	14,9	339,1	450,2	8
31190F50041A08	4 G 10	16,5	444,4	600,8	8
31190F50051A08	5 G 10	18,2	545,1	734,3	8
31190F50071A08	7 G 10	20	746,4	980,5	8

Other dimension and colours available on request.

CONTROL AND CONNECTION CABLES

GAALFLEX® CONTROL 600 SC

PVC control cable single conductor, 0,6/1 kV UL/CSA 600V



ELETTROTEK KABEL® GAALFLEX® CONTROL 600 SC

ELETTROTEK KABEL® GAALFLEX® CONTROL 600 SC

Construction:

- Conductor:** flexible red copper conductor Cl.5, acc.to IEC 60228, DIN VDE 0295
- Insulation:** PVC type Tl2 class 43 acc. to UL 1581
- Colour core:** black or green-yellow
- Outer sheath:** black (RAL 9005), PVC type TM2, acc.to DIN VDE 0281 part 1 + HD 21, and class 43 acc. to UL 1581

Resistance:



Self-extinguishing and flame retardant acc. to:
 DIN VDE 0482 part 265-2-1
 EN 50265-2-1
 IEC 60332-1-2,
 UL VW-1, CSA FT1 FT2

Technical data:

- Nominal voltage:** **DIN VDE**
 UoU 0,6/1 kV
UL/CSA
 600V
- Test voltage:** 4 kV
- Temperature range** **DIN VDE** **UL/CSA**
Fixed laying: -40°C up to +70°C up to +90°C
Flexible installation: +5°C up to +70°C up to +90°C
- Min. bending radius**
Fixed laying: 4 x d
Flexible installation: 7,5 x d
- Radiation resistance** 8 x 106 cJ/kg

Features:

- small bending radius
- chemical resistant
- UL recognized AWM Style 10107 90°C Oil 60°C 600 V,
 CSA AWM I/II A/B 90°C 600 V FT1 FT2 CE
- RoHS and CE approval



GREEN/YELLOW

Part no.	No.of cores x cross section n x mm ²	Outer-Ø ca.mm ± 10%	Copper weight kg/km	Cable weight approx. kg/km	AWG no.*)
31140F7P011A10	1 G 6	8,1	58	125	10
31140F7P011A08	1 G 10	9,4	96	190	8
31140F7P011A06	1 G 16	10,5	154	260	6
31140F7P011A04	1 G 25	11,8	240	380	4
31140F7P011A02	1 G 35	13,4	336	500	2
31140F7P011A01	1 G 50	16	480	680	1
31140F7P011A2C	1 G 70	18,4	672	920	2/0
31140F7P011A3C	1 G 95	20	912	1210	3/0
31140F7P011A4C	1 G 120	22,7	1152	1560	4/0
31140F7P011A5C	1 G 150	25,5	1440	1760	250 MCM
31140F7P011A7C	1 G 185	29	1776	2330	350 MCM
31140F7P011A9C	1 G 240	31,7	2304	2970	450 MCM

BLACK

Part no.	No.of cores x cross section n x mm ²	Outer-Ø ca.mm ± 10%	Copper weight kg/km	Cable weight approx. kg/km	AWG no.*)
31140F7L010A10	1 x 6	8,1	58	125	10
31140F7L010A08	1 x 10	9,4	96	190	8
31140F7L010A06	1 x 16	10,5	154	260	6
31140F7L010A04	1 x 25	11,8	240	380	4
31140F7L010A02	1 x 35	13,4	336	500	2
31140F7L010A01	1 x 50	16	480	680	1
31140F7L010A2C	1 x 70	18,4	672	920	2/0
31140F7L010A3C	1 x 95	20	912	1210	3/0
31140F7L010A4C	1 x 120	22,7	1152	1560	4/0
31140F7L010A5C	1 x 150	25,5	1440	1760	250 MCM
31140F7L010A7C	1 x 185	29	1776	2330	350 MCM
31140F7L010A9C	1 x 240	31,7	2304	2970	450 MCM

Other dimension and colours available on request.

CONTROL AND CONNECTION CABLES

GAALFLEX® CONTROL 600 SC CY

PVC control cable single conductor with overall screen, 0,6/1 kV UL/CSA 600V



ELETTROTEK KABEL® GAALFLEX® CONTROL 600 SC CY



ELETTROTEK KABEL® GAALFLEX® CONTROL 600 SC CY



Construction:

- Conductor:** flexible red copper conductor Cl.5, acc.to IEC 60228, DIN VDE 0295
- Insulation:** PVC type Tl2 class 43 acc. to UL 1581
- Colour core:** black or green-yellow
- Screen:** tinned copper braid
- Outer sheath:** black (RAL 9005), PVC type TM2, acc.to DIN VDE 0281 part 1 + HD 21, and class 43 acc. to UL 1581

Resistance:



Self-extinguishing and flame retardant acc. to:
 DIN VDE 0482 part 265-2-1
 EN 50265-2-1
 IEC 60332-1-2,
 UL VW-1, CSA FT1 FT2

Technical data:

- Nominal voltage:** **DIN VDE** UoU 0,6/1 kV
UL/CSA 600V
- Test voltage:** 4 kV
- Temperature range** **DIN VDE** **UL/CSA**
- Fixed laying:* -40°C up to +70°C up to +90°C
- Flexible installation:* +5°C up to +70°C up to +90°C
- Min. bending radius**
- Fixed laying:* 4 x d
- Flexible installation:* 7,5 x d
- Radiation resistance** 8 x 106 cJ/kg

Features:

- small bending radius
- chemical resistant
- UL recognized AWM Style 10107 90°C Oil 60°C 600 V, CSA AWM I/II A/B 90°C 600 V FT1 FT2 CE
- RoHS and CE approval



GREEN/YELLOW

Part no.	No. of cores x cross section n x mm ²	Outer-Ø ca.mm ± 10%	Copper weight kg/km	Cable weight approx. kg/km	AWG no.*)
31170F7P011A10	1 G 6	8,4	72	150	10
31170F7P011A08	1 G 10	9,8	130	240	8
31170F7P011A06	1 G 16	10,8	190	310	6
31170F7P011A04	1 G 25	12,4	260	430	4
31170F7P011A02	1 G 35	14,8	405	630	2
31170F7P011A01	1 G 50	16,8	560	840	1
31170F7P011A2C	1 G 70	18,8	780	1100	2/0
31170F7P011A3C	1 G 95	20,5	1030	1410	3/0
31170F7P011A4C	1 G 120	23,5	1285	1780	4/0
31170F7P011A5C	1 G 150	26,5	1430	1940	250 MCM
31170F7P011A7C	1 G 185	29,8	1940	2650	350 MCM
31170F7P011A9C	1 G 240	32,5	2530	3400	450 MCM

BLACK

Part no.	No. of cores x cross section n x mm ²	Outer-Ø ca.mm ± 10%	Copper weight kg/km	Cable weight approx. kg/km	AWG no.*)
31170F7L010A10	1 x 6	8,4	72	150	10
31170F7L010A08	1 x 10	9,8	130	240	8
31170F7L010A06	1 x 16	10,8	190	310	6
31170F7L010A04	1 x 25	12,4	260	430	4
31170F7L010A02	1 x 35	14,8	405	630	2
31170F7L010A01	1 x 50	16,8	560	840	1
31170F7L010A2C	1 x 70	18,8	780	1100	2/0
31170F7L010A3C	1 x 95	20,5	1030	1410	3/0
31170F7L010A4C	1 x 120	23,5	1285	1780	4/0
31170F7L010A5C	1 x 150	26,5	1430	1940	250 MCM
31170F7L010A7C	1 x 185	29,8	1940	2650	350 MCM
31170F7L010A9C	1 x 240	32,5	2530	3400	450 MCM

Other dimension and colours available on request.

CONTROL AND CONNECTION CABLES

GAALFLEX® CONTROL 600 MTW

PVC control cable type MTW, UL 600 V CSA 1000 V



ELETTROTEK KABEL® GAALFLEX® CONTROL 600 MTW



Construction:

Conductor:	flexible red copper conductor Cl. 5, acc to IEC 60228, DIN VDE 0295 and UL standard 758 table 5.1+ UL 1581 table 20.1
Insulation:	special PVC/Nylon compound
Colour cores:	black cores with consecutive numbers acc. to EN 50334, green-yellow from 3 cores
Stranding:	in layers
Outer sheath:	grey (RAL 7001) PVC type TM5, acc.to DIN VDE 0281 part 1 + HD 21.1 and class 43 acc. to UL 1581

Resistance:



Fire performance acc. to:
CSA FT1 and FT2



Impact and crushing acc. to:
UL 1277

Technical data:

Nominal voltage:	UL-AWM / (UL) 600V CSA 1000V
Test voltage:	4 kV
Temperature range	UL / CSA
<i>Fixed laying:</i>	-40°C up to +90°C
<i>Flexible installation:</i>	-25°C up to +90°C
Min. bending radius	
<i>Fixed laying:</i>	4 x d
<i>Flexible installation:</i>	6 x d

Features:

flexible cable for cable tray use
NFPA 79 for industrial machinery
machinery area suitable
(UL) Type MTW 600 AWM style 2587/21216 90°C
oil 60°C 600 V
CSA AWM I/II A/B 90°C 600 V FT1 FT2 CE
RoHS and CE approval



CONTROL AND CONNECTION CABLES

GAALFLEX® CONTROL 600 MTW

PVC control cable type MTW, UL 600V CSA 1000V



ELETTROTEK KABEL® GAALFLEX® CONTROL 600 MTW



Part no.	No. of cores x cross section n x mm ²	Outer-Ø ca. mm ± 10%	Copper weight kg/km	Cable weight approx. kg/km	AWG no. *)
31160G50031A18	3 G 1	7,7	28,8	86	18
31160G50041A18	4 G 1	8,3	38,4	103	18
31160G50051A18	5 G 1	9,1	48	123	18
31160G50071A18	7 G 1	9,8	57,2	151	18
31160G50091A18	9 G 1	12	86,4	196	18
31160G50121A18	12 G 1	12,6	115,2	235	18
31160G50161A18	16 G 1	14,7	153,6	320	18
31160G50181A18	18 G 1	15,4	172,8	354	18
31160G50191A18	19 G 1	16,2	182,4	374	18
31160G50251A18	25 G 1	18,2	240	465	18
31160G50271A18	27 G 1	18,2	259,2	491	18
31160G50371A18	37 G 1	20,3	355,2	639	18
31160G50501A18	50 G 1	24,8	480	898	18
31160G50031A16	3 G 1,5	8,4	43,2	107	16
31160G50041A16	4 G 1,5	9,1	57,6	128	16
31160G50051A16	5 G 1,5	9,8	72	153	16
31160G50071A16	7 G 1,5	10,7	100,8	191	16
31160G50081A16	8 G 1,5	12,3	115,2	229	16
31160G50091A16	9 G 1,5	13,2	129,6	255	16
31160G50121A16	12 G 1,5	14,5	172,8	323	16
31160G50161A16	16 G 1,5	16,1	230,4	409	16
31160G50181A16	18 G 1,5	16,8	259,2	452	16
31160G50191A16	19 G 1,5	16,8	273,6	466	16
31160G50251A16	25 G 1,5	20,1	360	604	16
31160G50271A16	27 G 1,5	20,1	388,8	641	16
31160G50411A16	41 G 1,5	25,1	590,4	993	16
31160G50501A16	50 G 1,5	27,3	720	1174	16
31160G50611A16	61 G 1,5	29	878,4	1390	16
31160G50031A14	3 G 2,5	9,3	72	143	14
31160G50041A14	4 G 2,5	10	96	173	14
31160G50051A14	5 G 2,5	11	120	209	14
31160G50071A14	7 G 2,5	11,9	168	265	14
31160G50091A14	9 G 2,5	15,4	216	373	14
31160G50121A14	12 G 2,5	16,1	288	446	14
31160G50181A14	18 G 2,5	18,8	432	633	14
31160G50251A14	25 G 2,5	23,5	600	902	14
31160G50031A12	3 G 4	10,5	115,2	199	12
31160G50041A12	4 G 4	11,4	153,6	244	12
31160G50051A12	5 G 4	12,5	192	296	12
31160G50071A12	7 G 4	14,4	268,8	404	12
31160G50031A10	3 G 6	12,4	172,8	285	10
31160G50041A10	4 G 6	14,3	230,4	377	10
31160G50051A10	5 G 6	15,6	288	453	10
31160G50071A10	7 G 6	17	403,2	584	10
31160G50041A08	4 G 10	18,1	337,9	586	8
31160G50051A08	5 G 10	19,9	422,4	709	8
31160G50041A06	4 G 16	22,8	541,4	919	6
31160G50051A06	5 G 16	25,1	676,8	1110	6
31160G50041A04	4 G 25	27,4	844,8	1386	4
31160G50051A04	5 G 25	30,3	1056	1684	4
31160G50041A02	4 G 35	31,8	1344	1976	2
31160G50051A02	5 G 35	35,2	1680	2398	2

Other dimension and colours available on request.

CONTROL AND CONNECTION CABLES

GAALFLEX® CONTROL 600 MTW CY Lean

PVC control cable and type MTW with overall copper screen, UL 600V CSA 1000V



ELETTROTEK KABEL® GAALFLEX® CONTROL 600 MTW CY

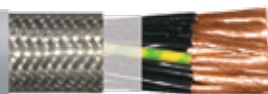

Construction:

Conductor:	flexible red copper conductor Cl. 5, acc to IEC 60228, DIN VDE 0295 and UL standard 758 table 5.1+ UL 1581 table 20.1
Insulation:	special PVC/Nylon compound
Colour cores:	black cores with consecutive numbers acc. to EN 50334, green-yellow from 3 cores
Stranding:	in layers
Wrapping:	non woven tape
Screen:	tinned copper braid
Outer sheath:	grey (RAL 7001) PVC type TM5, acc.to DIN VDE 0281 part 1+ HD 21.1 and class 43 acc. to UL 1581

Resistance:



Fire performance acc. to:
CSA FT1 and FT2



Impact and crushing acc. to:
UL 1277

Technical data:

Nominal voltage:	UL-AWM / (UL) 600V CSA 1000V
Test voltage:	4 kV core/core 2 kV core/screen
Temperature range	UL / CSA
<i>Fixed laying:</i>	-40°C up to +90°C
<i>Flexible installation:</i>	-25°C up to +90°C
Min. bending radius	
<i>Fixed laying:</i>	5 x d
<i>Flexible installation:</i>	10 x d

Features:

flexible cable for cable tray use
NFPA 79 for industrial machinery
machinery area suitable
(UL) Type MTW 600 AWM style 2587/21216 90°C
oil 60°C 600 V
CSA AWM I/II A/B 90°C 600 V FT1 FT2 CE

RoHS and CE approval



CONTROL AND CONNECTION CABLES

GAALFLEX® CONTROL 600 MTW CY Lean

PVC control cable and type MTW with overall copper screen, UL 600V CSA 1000V



ELETTROTEK KABEL® GAALFLEX® CONTROL 600 MTW CY

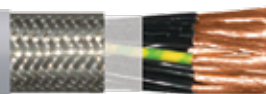

Part no.	No. of cores x cross section n x mm ²	Outer-Ø ca. mm ± 10%	Copper weight kg/km	Cable weight approx. kg/km	AWG no. *)
31200G50031A18	3 G 1	8,5	50,3	97	18
31200G50041A18	4 G 1	9,2	62,2	116	18
31200G50051A18	5 G 1	9,9	74,3	142	18
31200G50071A18	7 G 1	10,6	96,4	167	18
31200G50091A18	9 G 1	13	146	244	18
31200G50121A18	12 G 1	14,3	175,1	293	18
31200G50161A18	16 G 1	15,9	251	397	18
31200G50181A18	18 G 1	16,6	270,9	431	18
31200G50191A18	19 G 1	17,4	292,4	460	18
31200G50251A18	25 G 1	19,4	364	560	18
31200G50271A18	27 G 1	19,4	383,2	586	18
31200G50371A18	37 G 1	22,6	494,2	802	18
31200G50501A18	50 G 1	26	650	1029	18
31200G50031A16	3 G 1,5	9,2	67	117	16
31200G50041A16	4 G 1,5	9,9	83,9	140	16
31200G50051A16	5 G 1,5	10,5	101,2	178	16
31200G50071A16	7 G 1,5	11,7	154,8	222	16
31200G50081A16	8 G 1,5	14,1	175	300	16
31200G50091A16	9 G 1,5	15,1	215,5	347	16
31200G50121A16	12 G 1,5	15,9	270,2	401	16
31200G50161A16	16 G 1,5	17,3	340,3	495	16
31200G50181A16	18 G 1,5	18,1	370,1	539	16
31200G50191A16	19 G 1,5	18,1	384,5	553	16
31200G50251A16	25 G 1,5	22,4	498,6	766	16
31200G50271A16	27 G 1,5	22,4	527,4	802	16
31200G50411A16	41 G 1,5	26,3	761,2	1125	16
31200G50501A16	50 G 1,5	28,5	896,4	1309	16
31200G50611A16	61 G 1,5	30,2	1075,7	1540	16
31200G50031A14	3 G 2,5	10,1	101	169	14
31200G50041A14	4 G 2,5	11	143,6	200	14
31200G50051A14	5 G 2,5	12	174,2	236	14
31200G50071A14	7 G 2,5	12,9	227,5	295	14
31200G50091A14	9 G 2,5	16,6	314,1	451	14
31200G50121A14	12 G 2,5	17,4	398	532	14
31200G50181A14	18 G 2,5	20,1	557,1	731	14
31200G50121A14	25 G 2,5	24,8	767,1	1031	14
31200G50031A12	3 G 4	11,5	163,1	239	12
31200G50041A12	4 G 4	12,5	208,1	289	12
31200G50051A12	5 G 4	14,3	251,9	367	12
31200G50071A12	7 G 4	15,6	365,9	481	12
31200G50031A10	3 G 6	14,1	232,6	356	10
31200G50041A10	4 G 6	15,5	327,4	453	10
31200G50051A10	5 G 6	16,8	386,4	530	10
31200G50071A10	7 G 6	18,2	514,3	670	10
31200G50041A08	4 G 10	19,3	461,8	682	8
31200G50051A08	5 G 10	22,2	560,6	870	8
31200G50041A06	4 G 16	24	683,1	1030	6
31200G50051A06	5 G 16	25,9	846,6	1237	6
31200G50041A04	4 G 25	28,6	1021,4	1521	4
31200G50051A04	5 G 25	31,5	1258,3	1838	4
31200G50041A02	4 G 35	33	1552,1	2134	2
31200G50051A02	5 G 35	36,4	1914,1	2574	2

Other dimension and colours available on request.

CONTROL AND CONNECTION CABLES

GAALFLEX® CONTROL 60I (H05VV5-F)

PVC control cable with numbered cores DIN VDE 300/500 V UL/CSA 600 V



ELETTROTEK KABEL® GAALFLEX® CONTROL 60I



Construction:

Conductor:	flexible red copper conductor Cl. 5, acc to IEC 60228, DIN VDE 0295
Insulation:	PVC type T11 acc. to DIN VDE 0207, UL 1581
Colour cores:	black cores with consecutive numbers acc. to EN 50334, green-yellow from 3 cores
Stranding:	in layers
Outer sheath:	grey (RAL 7001) PVC type TM5, acc. to DIN VDE 0281 part 1+ HD 21.1 and class 43 acc. to UL 1581

Resistance:



Self-extinguishing and flame retardant acc. to:
DIN VDE 0482 part 265-2-1 EN 50265-2-1
IEC 60332-1-2,
DIN VDE 0482 part 266-2 part 3,
EN 50266-2, IEC 60332-3C
UL VW1 CSA, CSA FT1

Technical data:

Nominal voltage:	<HAR> U ₀ / U 300/500 UL / CSA 600V
Test voltage:	3 kV
Temperature range	
<i>Fixed laying:</i>	<HAR> -40°C up to +70°C UL / CSA -40°C up to +90°C
<i>Flexible installation:</i>	<HAR> -5°C up to +70°C UL / CSA -5°C up to +90°C
Min. bending radius	
<i>Fixed laying:</i>	4 x d
<i>Flexible installation:</i>	12,5 x d

Features:

AWM Style 2587 600 V 90°C
CSA AWM I/II A/B 90°C 600 V FT1 CE

flexible

<HAR> HD 21.13 S1

RoHS and CE approval



CONTROL AND CONNECTION CABLES

GAALFLEX® CONTROL 60I (H05VV5-F)

PVC control cable with numbered cores DIN VDE 300/500 V UL/CSA 600 V



ELETTROTEK KABEL® GAALFLEX® CONTROL 60I

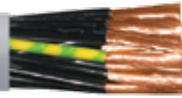

Part no.	No. of cores x cross section n x mm ²	Outer-Ø ca. mm ± 10%	Copper weight kg/km	Cable weight approx. kg/km	AWG no. *)
31410F51020A20	2 X 0,5	5,7	9,6	44	20
31410F50031A20	3 G 0,5	6,1	14,4	54,9	20
31410F50041A20	4 G 0,5	6,7	19,2	66,4	20
31410F50051A20	5 G 0,5	7,5	24	82,9	20
31410F50071A20	7 G 0,5	8,2	33,6	126	20
31410F50121A20	12 G 0,5	10,9	57,6	181,7	20
31410F50181A20	18 G 0,5	13,0	86,4	256	20
31410F50191A20	19 G 0,5	13,0	91,2	287,2	20
31410F50251A20	25 G 0,5	15,2	120	357,8	20
31410F50271A20	27 G 0,5	16,1	129,6	402,3	20
31410F50341A20	34 G 0,5	17,6	163,2	482,5	20
31410F50411A20	41 G 0,5	19,5	196,6	577,1	20
31410F50501A20	50 G 0,5	21,3	240	705	20
31410F50611A20	61 G 0,5	22,9	292,8	889,6	20
31410F51020A19	2 X 0,75	6,1	14,4	55,6	19
31410F50031A19	3 G 0,75	6,6	21,6	66,4	19
31410F50041A19	4 G 0,75	7,3	28,8	80,9	19
31410F50051A19	5 G 0,75	8,1	36	100,9	19
31410F50071A19	7 G 0,75	8,9	50,4	153,4	19
31410F50121A19	12 G 0,75	11,9	86,4	229,5	19
31410F50181A19	18 G 0,75	14,2	129,6	323,6	19
31410F50191A19	19 G 0,75	14,2	136,8	361,5	19
31410F50251A19	25 G 0,75	16,5	180	451,2	19
31410F50271A19	27 G 0,75	17,6	194,4	505,5	19
31410F50341A19	34 G 0,75	19,2	244,8	607,2	19
31410F50371A19	37 G 0,75	19,6	266,4	691,4	19
31410F50411A19	41 G 0,75	21,2	295,2	726,1	19
31410F50501A19	50 G 0,75	23,2	360	887,0	19
31410F50611A19	61 G 0,75	24,9	439,2	1117	19
31410F51020A18	2 X 1	6,5	19,2	63,4	18
31410F50031A18	3 G 1	6,9	28,8	76,6	18
31410F50041A18	4 G 1	7,7	38,4	97,4	18
31410F50051A18	5 G 1	8,5	48	116,9	18
31410F50071A18	7 G 1	9,4	67,2	182,7	18
31410F50121A18	12 G 1	12,6	115,2	267,6	18
31410F50181A18	18 G 1	15,0	172,8	385,9	18
31410F50191A18	19 G 1	15,0	182,4	422,1	18
31410F50251A18	25 G 1	17,5	240	536,8	18
31410F50271A18	27 G 1	18,6	259,2	591	18
31410F50341A18	34 G 1	20,4	326,4	721,4	18
31410F50371A18	37 G 1	20,8	355,2	819,2	18
31410F50411A18	41 G 1	22,6	393,6	862,3	18
31410F50501A18	50 G 1	24,7	480	1053,1	18
31410F50611A18	61 G 1	26,5	585,6	1336,8	18
31410F51020A16	2 X 1,5	7,6	28,8	90,4	16
31410F50031A16	3 G 1,5	8,2	43,2	109,8	16
31410F50041A16	4 G 1,5	9,1	57,6	139	16
31410F50051A16	5 G 1,5	10,1	72	167,2	16
31410F50071A16	7 G 1,5	11,1	100,8	260,2	16
31410F50121A16	12 G 1,5	14,9	172,8	389,8	16
31410F50181A16	18 G 1,5	17,9	259,2	559,3	16
31410F50191A16	19 G 1,5	17,9	273,6	612,3	16
31410F50251A16	25 G 1,5	20,9	360	776,4	16
31410F50271A16	27 G 1,5	22,2	388,8	865,5	16
31410F50341A16	34 G 1,5	24,3	489,6	1.040,6	16
31410F50371A16	37 G 1,5	24,8	532,8	1.180,1	16
31410F50411A16	41 G 1,5	26,9	590,4	1.255,6	16
31410F50501A16	50 G 1,5	29,5	720	1.546,7	16
31410F50611A16	61 G 1,5	31,6	878,4	1.906,8	16

CONTROL AND CONNECTION CABLES

GAALFLEX® CONTROL 60I (H05VV5-F)

PVC control cable with numbered cores DIN VDE 300/500 V UL/CSA 600 V



ELETTROTEK KABEL® GAALFLEX® CONTROL 60I

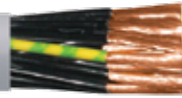

Part no.	No. of cores x cross section n x mm ²	Outer-Ø ca. mm ± 10%	Copper weight kg/km	Cable weight approx. kg/km	AWG no. *)
31410F51020A14	2 X 2,5	9,0	48	131,5	14
31410F50031A14	3 G 2,5	9,7	72	161,7	14
31410F50041A14	4 G 2,5	10,7	96	204,5	14
31410F50051A14	5 G 2,5	12,0	120	252,4	14
31410F50071A14	7 G 2,5	13,2	168	388,8	14
31410F50121A14	12 G 2,5	17,8	288	583,6	14
31410F50181A14	18 G 2,5	21,3	432	836,2	14
31410F50191A14	19 G 2,5	21,3	456	925,7	14
31410F50251A14	25 G 2,5	24,9	600	1171,5	14
31410F50271A14	27 G 2,5	26,5	648	1301,6	14
31410F50341A14	34 G 2,5	29,0	816	1566,4	14
31410F50371A14	37 G 2,5	29,6	888	1771,4	14
31410F50411A14	41 G 2,5	32,1	984	1869,8	14
31410F50501A14	50 G 2,5	35,2	1200	2269,2	14
31410F50611A14	61 G 2,5	37,8	1464	2808,4	14

Other dimension and colours available on request.

CONTROL AND CONNECTION CABLES

GAALFLEX® CONTROL 60I CY (H05VVC4V5-K)

PVC control cable with numbered cores, inner sheath and overall copper screen,
DIN VDE 300/500 V UL/CSA 600 V



ELETTROTEK KABEL® GAALFLEX® CONTROL 60I CY

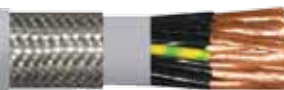

Construction:

Conductor:	flexible red copper conductor Cl. 5, acc to IEC 60228, DIN VDE 0295
Insulation:	PVC type T11 acc. to DIN VDE 0207, UL 1581
Colour cores:	black cores with consecutive numbers acc. to EN 50334, green-yellow from 3 cores
Stranding:	in layers
Inner sheath:	PVC type TM2 acc. to DIN VDE 0207, UL 1581
Screen:	tinned copper braid
Outer sheath:	grey (RAL 7001) PVC type TM5, acc. to DIN VDE 0281 part 1+ HD 21.1 and class 43 acc. to UL 1581

Resistance:



Self-extinguishing and flame retardant acc. to:
DIN VDE 0482 part 265-2-1 EN 50265-2-1
IEC 60332-1-2,
DIN VDE 0482 part 266-2 part 3,
EN 50266-2, IEC 60332-3C
UL VW1 CSA, CSA FT1

Technical data:

Nominal voltage:	<HAR> U ₀ / U 300/500 UL / CSA 600V
Test voltage:	3 kV
Temperature range <i>Flexible installation:</i>	<HAR> - 40°C up to +70°C UL / CSA - 40°C up to +90°C
Min. bending radius:	12,5 x d

Features:

AWM Style 2587 600 V 90°C
CSA AWM I/II A/B 90°C 600 V FT1 CE

flexible

<HAR> HD 21.13 S1

good EMC characteristics

RoHS and CE approval



CONTROL AND CONNECTION CABLES

GAALFLEX® CONTROL 60I CY (H05VVC4V5-K)

PVC control cable with numbered cores, inner sheath and overall copper screen,
DIN VDE 300/500 V UL/CSA 600 V



ELETTROTEK KABEL® GAALFLEX® CONTROL 60I CY

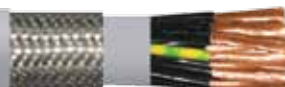

Part no.	No. of cores x cross section n x mm ²	Outer-Ø ca. mm ± 10%	Copper weight kg/km	Cable weight approx. kg/km	AWG no. *)
31420F51020A20	2 X 0,5	8	32,8	97,1	20
31420F50031A20	3 G 0,5	8,4	42,3	112,4	20
31420F50041A20	4 G 0,5	8,9	47,1	125,2	20
31420F50051A20	5 G 0,5	9,7	56,6	150,1	20
31420F50071A20	7 G 0,5	11,3	70,8	199,1	20
31420F50121A20	12 G 0,5	13,7	115,4	299,7	20
31420F50181A20	18 G 0,5	15,6	152,6	390,6	20
31420F50251A20	25 G 0,5	18	202,5	522,5	20
31420F50341A20	34 G 0,5	20,5	254	670,5	20
31420F51020A19	2 X 0,75	8,4	42,3	112,4	19
31420F50031A19	3 G 0,75	8,8	49,6	125,1	19
31420F50041A19	4 G 0,75	9,6	56,7	146,6	19
31420F50051A19	5 G 0,75	10,3	68,5	171,8	19
31420F50071A19	7 G 0,75	12,2	87,6	235	19
31420F50121A19	12 G 0,75	14,5	152,5	353,6	19
31420F50181A19	18 G 0,75	16,9	203,9	477,5	19
31420F50251A19	25 G 0,75	19,6	270,8	641,7	19
31420F50341A19	34 G 0,75	22,1	343,9	814,6	19
31420F51020A18	2 X 1	8,7	47,1	121,3	18
31420F50031A18	3 G 1	9,3	56,7	140,4	18
31420F50041A18	4 G 1	9,9	70,9	164,5	18
31420F50051A18	5 G 1	10,9	80,6	194,8	18
31420F50071A18	7 G 1	12,9	109,1	271,3	18
31420F50121A18	12 G 1	15,4	181,3	404,5	18
31420F50181A18	18 G 1	17,7	255,5	547,8	18
31420F50251A18	25 G 1	20,4	330,9	720,8	18
31420F50341A18	34 G 1	23,3	433,9	943,4	18
31420F51020A16	2 X 1,5	9,9	61,3	158	16
31420F50031A16	3 G 1,5	10,4	75,8	179,9	16
31420F50041A16	4 G 1,5	11,3	94,8	217	16
31420F50051A16	5 G 1,5	12,6	113,8	267	16
31420F50071A16	7 G 1,5	14,9	167	378,5	16
31420F50121A16	12 G 1,5	17,6	247,1	537,8	16
31420F50181A16	18 G 1,5	20,5	350	742,6	16
31420F50251A16	25 G 1,5	23,9	467,3	1004,8	16
31420F50341A16	34 G 1,5	27,5	613,5	1327,4	16
31420F51020A14	2 X 2,5	11,3	85,2	210,1	14
31420F50031A14	3 G 2,5	12,0	109,2	246,1	14
31420F50041A14	4 G 2,5	13,3	154	316,4	14
31420F50051A14	5 G 2,5	14,6	186	382,6	14
31420F50071A14	7 G 2,5	17,3	242,3	523	14
31420F50121A14	12 G 2,5	20,6	379	768,9	14
31420F50181A14	18 G 2,5	24,3	539,4	1080	14
31420F50251A14	25 G 2,5	28,0	732,1	1449,2	14
31420F50341A14	34 G 2,5	32,1	964,7	1906	14

Other dimension and colours available on request.

CONTROL AND CONNECTION CABLES

GAALFLEX® TRAY 600

Special PVC UV and oil resistant, flexible tray cable, Machine-Tool cable,
UL-AWM / (UL) / c(UL): 600V, (UL) WTTC: 1000V

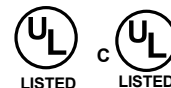

ELETTROTEK KABEL® GAALFLEX® TRAY 600

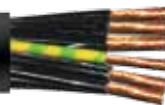

Construction:

Conductor:	flexible red copper conductor Cl. 5, acc to IEC 60228, DIN VDE 0295 and UL standard 83 + UL 1581 table 20.1.1
Insulation:	special PVC/Nylon compound: from 1 sqmm up to 1,5 sqmm: UL TFFN > 1,5 sqmm: UL THHN
Colour cores:	black cores with consecutive numbers acc. to EN 50334, green-yellow from 3 cores
Stranding:	in layers
Outer sheath:	black (RAL 9005), special PVC oil resistant compound

Resistance:



Fire performance acc. to:
(UL) FT4 and c(UL) FT1 FT2 FT4

Technical data:

Nominal voltage:	UL-AWM / (UL) / c(UL): 600V (UL) WTTC: 1000V
Test voltage:	2 kV
Temperature range	(UL) / c(UL): up to +90°C
<i>Fixed laying:</i>	- 40°C
Radiation resistance:	8 x 107 cJ/kg
Min. bending radius:	
<i>Fixed laying:</i>	5 x d
<i>Flexible installation:</i>	15 x d

Features:

UL AWM style 2587 90°C 600 V
(UL) type TC-ER 90°C 600 V
FT4 (UL) WTTC 90°C 1000 V (UL)
MTW 600 V flexing
Type CIC 90°C dry 600 V FT1 FT2 FT4 CE

New: improved with WTTC approval

WTTC: UL subject 2277

TC: UL Standard 1277

exposed runs
cable for tray use
UV resistance
RoHS and CE approval



CONTROL AND CONNECTION CABLES

GAALFLEX® TRAY 600

Special PVC UV and oil resistant, flexible tray cable, Machine-Tool cable,
UL-AWM / (UL) / c(UL): 600V, (UL) WTTC: 1000 V

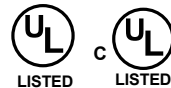

ELETTROTEK KABEL® GAALFLEX® TRAY 600

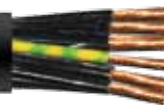

Part no.	No. of cores x cross section n x mm ²	Outer-Ø ca.mm ± 10%	Copper weight kg/km	Cable weight approx. kg/km	AWG no. *)
32010G71020A18	2 x 1	6,9	19	76	18
32010G70031A18	3 G 1	7,3	29	89	18
32010G70041A18	4 G 1	7,9	38	107	18
32010G70051A18	5 G 1	8,5	48	126	18
32010G70071A18	7 G 1	9,2	67	155	18
32010G70091A18	9 G 1	11,3	86,4	196,5	18
32010G70121A18	12 G 1	12	115	244	18
32010G70161A18	16 G 1	13,9	153,6	333,5	18
32010G70181A18	18 G 1	14,6	173	372	18
32010G70191A18	19 G 1	14,6	182,4	384	18
32010G70251A18	25 G 1	17,4	240	496	18
32010G70271A18	27 G 1	17,4	259,2	521	18
32010G70371A18	37 G 1	19,6	355,2	695	18
32010G70501A18	50 G 1	23,6	480	943	18
32010G71020A16	2 x 1,5	7,5	29	93,5	16
32010G70031A16	3 G 1,5	7,9	43	110	16
32010G70041A16	4 G 1,5	8,5	58	133	16
32010G70051A16	5 G 1,5	9,3	72	160	16
32010G70071A16	7 G 1,5	10,1	101	199	16
32010G70081A16	8 G 1,5	11,7	115,2	230	16
32010G70091A16	9 G 1,5	12,5	129,6	256	16
32010G70121A16	12 G 1,5	13,9	173	341	16
32010G70161A16	16 G 1,5	15,4	230,4	435	16
32010G70181A16	18 G 1,5	16,2	259,5	486	16
32010G70191A16	19 G 1,5	16,2	273,6	501	16
32010G70251A16	25 G 1,5	19,2	360	644	16
32010G70271A16	27 G 1,5	19,2	388,8	675,4	16
32010G70371A16	37 G 1,5	22,4	532,8	942	16
32010G70411A16	41 G 1,5	24,0	590,4	1023	16
32010G70501A16	50 G 1,5	26,5	720	1253	16
32010G70611A16	61 G 1,5	27,8	878,4	1460	16
32010G70031A14	3 G 2,5	8,8	72	148	14
32010G70041A14	4 G 2,5	9,5	96	182	14
32010G70051A14	5 G 2,5	10,3	120	219	14
32010G70071A14	7 G 2,5	11,4	168	280	14
32010G70091A14	9 G 2,5	14,1	216	349	14
32010G70121A14	12 G 2,5	15,6	288	470	14
32010G70181A14	18 G 2,5	18,3	432	682	14
32010G70251A14	25 G 2,5	22,7	600	942	14
32010G70031A12	3 G 4	10,2	115	216	12
32010G70041A12	4 G 4	11	154	266	12
32010G70051A12	5 G 4	12,1	192	326	12
32010G70061A12	6 G 4	13,2	230,4	371	12
32010G70071A12	7 G 4	13,2	268,8	415	12
32010G70031A10	3 G 6	12,8	173	329	10
32010G70041A10	4 G 6	14	230	408	10
32010G70051A10	5 G 6	15,4	288	497	10
32010G70071A10	7 G 6	16,8	403,2	625	10
32010G70031A08	3 G 10	17	288	568	8
32010G70041A08	4 G 10	18,7	384	705	8
32010G70051A08	5 G 10	21,5	480	880	8
32010G70071A08	7 G 10	23,5	672	1134	8
32010G70031A06	3 G 16	19,4	461	796	6
32010G70041A06	4 G 16	22,4	614	1056	6
32010G70051A06	5 G 16	24,3	768	1243	6
32010G70041A04	4 G 25	27,2	960	1648	4
32010G70051A04	5 G 25	29,7	1200	1535	4
32010G70041A02	4 G 35	31,3	1344	2260	2
32010G70051A02	5 G 35	34,7	1680	2731	2

Other dimension and colours available on request.

CONTROL AND CONNECTION CABLES

GAALFLEX® TRAY 1002

Special PVC oil resistant, flexible tray cable, Machine-Tool cable,
acc. to UL 1277 (TC-ER) and UL 1063 (MTW), 600V TC & MTW, 1000V AWM & IEC

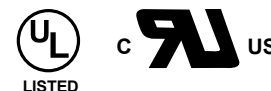

ELETTROTEK KABEL® GAALFLEX® TRAY 1002

Construction:

Conductor:	flexible red copper conductor Cl. 5, acc to IEC 60228, DIN VDE 0295 and UL standard 83 from 18 to 16 AWG: cores type TFF from 14 AWG and over: cores type THHW
Insulation:	GAALTHERM® 522
Colour cores:	black cores with consecutive numbers acc. to EN 50334, green-yellow from 3 cores
Stranding:	in layers
Outer sheath:	black (RAL 9005), special PVC oil resistant compound acc. to UL 1277 and UL 1063

Technical data:

Nominal voltage:	UL-TC/MTW 600 V
Nominal voltage:	IEC / UL-AWM 1000 V
Test voltage:	4 kV
Temperature range	
<i>Fixed laying:</i>	- 40°C up to +90°C (UL-AWM up to +105°C)
<i>Flexible application:</i>	- 5°C up to +90°C (UL-AWM up to +105°C)
Min. bending radius:	
<i>Fixed laying:</i>	4 x d
<i>Flexible installation:</i>	13 x d

Resistance:



Fire performance acc. to:
(UL) FT4/IEEE, UL 1685



Oil resistance acc. to:
to UL OIL RES I



UV resistant / Sunlight resistant:
acc. to EN 50396 and HD 605 A1, UL 1581

Features:

UL AWM style 10012/21179 90°C 600 or 1000 V, CSA AWM I/II A/B
acc. to UL 1063 UL(MTW) and UL 1277 (TC-ER)
oil resistant acc. to UL OIL RES I,
water resistance and UL Wet approval 75°C
acc. to UL 2277: Flexible Motor Supply Lead Cable
and Wind Turbine Tray Cable (WTTC)
acc. to NFPA 79 2007 and NEC 336.10(7)
class 1 Div. 2 art 336, 392, 501
Direct burial acc. to UL 1277 part. 5.2. (wet location insulations)
and 18.1 - 18.6 (crushing test)
outdoor use
exposed runs
cable for tray use
oil resistance
water resistance
RoHS and CE approval



CONTROL AND CONNECTION CABLES

GAALFLEX® TRAY 1002

Special PVC oil resistant, flexible tray cable, Machine-Tool cable,
acc. to UL 1277 (TC-ER) and UL 1063 (MTW), 600 V TC & MTW, 1000 V AWM & IEC



ELETTROTEK KABEL® GAALFLEX® TRAY 1002

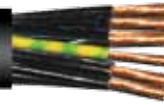

Part no.	No. of cores x cross section n x mm ²	Outer-Ø ca. mm ± 10%	Copper weight kg/km	Cable weight approx. kg/km	AWG no. *)
32230H71020A18	2 x 1	8	19,2	90	18
32230H70031A18	3 G 1	8,4	28,8	105	18
32230H70041A18	4 G 1	9,2	38,4	125	18
32230H70051A18	5 G 1	10	48	150	18
32230H70071A18	7 G 1	10,9	67,2	185	18
32230H70081A18	8 G 1	12,8	76,8	245	18
32230H70101A18	10 G 1	14,2	96	305	18
32230H70121A18	12 G 1	14,7	115,2	335	18
32230H70181A18	18 G 1	17,1	172,8	470	18
32230H70251A18	25 G 1	19,5	240	620	18
32230H71020A16	2 x 1,5	8,7	28,8	110	16
32230H70031A16	3 G 1,5	9,2	43,2	130	16
32230H70041A16	4 G 1,5	10	57,6	150	16
32230H70051A16	5 G 1,5	10,9	72	190	16
32230H70071A16	7 G 1,5	11,9	100,8	240	16
32230H70081A16	8 G 1,5	14,6	115,2	335	16
32230H70121A16	12 G 1,5	16,1	172,8	430	16
32230H70181A16	18 G 1,5	18,8	259,2	600	16
32230H70251A16	25 G 1,5	22,7	360	860	16
32230H71020A14	2 x 2,5	9,5	48	150	14
32230H70031A14	3 G 2,5	10	72	170	14
32230H70041A14	4 G 2,5	10,9	96	210	14
32230H70051A14	5 G 2,5	12	120	255	14
32230H70071A14	7 G 2,5	13,1	168	325	14
32230H70081A14	8 G 2,5	16,1	192	440	14
32230H70121A14	12 G 2,5	17,8	288	580	14
32230H70181A14	18 G 2,5	20,9	432	820	14
32230H70031A12	3 G 4	11,4	115,2	235	12
32230H70041A12	4 G 4	12,5	153,6	295	12
32230H70051A12	5 G 4	14,5	192	385	12
32230H70071A12	7 G 4	15,8	268,8	485	12
32230H70031A10	3 G 6	12,6	172,8	310	10
32230H70041A10	4 G 6	14,6	230,4	415	10
32230H70051A10	5 G 6	16	288	510	10
32230H70031A08	3 G 10	17,1	288	550	8
32230H70041A08	4 G 10	18,7	384	685	8
32230H70051A08	5 G 10	20,7	480	850	8
32230H70031A06	3 G 16	20,8	460,8	840	6
32230H70041A06	4 G 16	23,9	614,4	1115	6
32230H70051A06	5 G 16	26,4	768	1375	6
32230H70041A04	4 G 25	27,4	960	1580	4
32230H70041A02	4 G 35	30,1	1344	2050	2
32230H70041A01	4 G 50	36,8	1920	2980	1
32230H70041A2C	4 G 70	41,8	2688	3975	2/0
32230H70041A3C	4 G 95	46,8	3648	5200	3/0
32230H70041A4C	4 G 120	49,4	4608	6330	4/0
32230H70041A5C	4 G 150	55	5760	7660	250 MCM

Other dimension and colours available on request.

CONTROL AND CONNECTION CABLES

GAALFLEX® TRAY 600 CY Lean

Special PVC UV and oil resistant, flexible tray cable, Machine-Tool cable
with overall copper screen, UL-AWM / (UL) / c(UL): 600V, (UL) WTTC: 1000 V

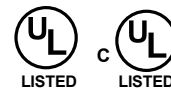

ELETTROTEK KABEL® GAALFLEX® TRAY 600 CY lean

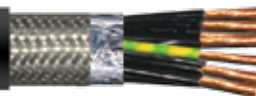

Construction:

Conductor:	flexible red copper conductor Cl. 5, acc to IEC 60228, DIN VDE 0295 and UL standard 758 table 5.1 + UL 1518 table 20.1
Insulation:	special PVC/Nylon compound: from 1 sqmm up to 1,5 sqmm: UL TFFN > 1,5 sqmm: UL THHN
Colour cores:	black cores with consecutive numbers acc. to EN 50334, green-yellow from 3 cores
Stranding:	in layers
Screen:	aluminium tape and tinned copper braid + tinned copper drain wire
Outer sheath:	black (RAL 9005), special PVC oil resistant compound

Resistance:



Fire performance acc. to:
(UL) FT4 and c(UL) FT1 FT2 FT4

Technical data:

Nominal voltage:	UL-AWM / (UL) / c(UL): 600V (UL) WTTC: 1000V
Test voltage:	2 kV
Temperature range	(UL) / c(UL): up to +90°C
<i>Fixed laying:</i>	- 40°C
Radiation resistance:	8 x 10 ⁷ cJ/kg
Min. bending radius:	
<i>Fixed laying:</i>	6 x d
<i>Flexible installation:</i>	20 x d

Features:

UL AWM style 2587 90°C 600 V
(UL) Type TC-ER 90°C 600 V,
FT4 (UL) WTTC 90°C 1000 V (UL)
MTW 600 V flexing
Type CIC SCREENED 90°C dry 600 V FT1 FT2 FT4 CE

flexible cable for cable tray use
new: improved with WTTC approval
WTTC:UL subject 2277
TC: UL Standard 1277
exposed runs
UV resistance
RoHS and CE approval



CONTROL AND CONNECTION CABLES

GAALFLEX® TRAY 600 CY Lean

Special PVC UV and oil resistant, flexible tray cable, Machine-Tool cable
with overall copper screen, UL-AWM / (UL) / c(UL): 600V, (UL) WTTC: 1000V

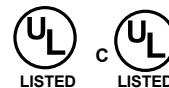

ELETTROTEK KABEL® GAALFLEX® TRAY 600 CY lean

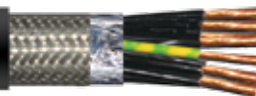

Part no.	No. of cores x cross section n x mm ²	Outer-Ø ca. mm ± 10%	Copper weight kg/km	Cable weight approx. kg/km	AWG no. *)
32060G70031A18	3 G 1	8,1	51	110	18
32060G70041A18	4 G 1	8,5	64	119	18
32060G70051A18	5 G 1	9,3	77	152	18
32060G70071A18	7 G 1	10,1	101	186	18
32060G70031A16	3 G 1,5	8,6	71	118	16
32060G70041A16	4 G 1,5	9,2	89	155	16
32060G70051A16	5 G 1,5	10,1	108	183	16
32060G70071A16	7 G 1,5	10,9	143	226	16
32060G70121A16	12 G 1,5	14,8	240	384	16
32060G70181A16	18 G 1,5	17,2	346	557	16
32060G70251A16	25 G 1,5	20,2	472	727	16
32060G70031A14	3 G 2,5	9,6	106	169	14
32060G70041A14	4 G 2,5	10,5	136	214	14
32060G70051A14	5 G 2,5	11,2	166	246	14
32060G70071A14	7 G 2,5	12,4	223	313	14
32060G70121A14	12 G 2,5	16,6	311,7	531	14
32060G70181A14	18 G 2,5	19,4	496,5	725	14
32060G70251A14	25 G 2,5	23,8	634	1062	14
32060G70041A14	4 G 2,5	10,5	136	214	14
32060G70051A14	5 G 2,5	11,2	166	246	14
32060G70071A14	7 G 2,5	12,4	223	313	14
32060G70121A14	12 G 2,5	16,6	311,7	531	14
32060G70181A14	18 G 2,5	19,4	496,5	725	14
32060G70251A14	25 G 2,5	23,8	634	1062	14
32060G70031A12	3 G 4	11,0	140	231	12
32060G70041A12	4 G 4	11,6	205	279	12
32060G70051A12	5 G 4	13,0	175,5	340	12
32060G70071A12	7 G 4	14,8	294,2	468	12
32060G70031A10	3 G 6	13,1	232	345	10
32060G70041A10	4 G 6	14,9	306	443	10
32060G70051A10	5 G 6	16,4	320	547	10
32060G70071A10	7 G 6	17,7	408	677	10
32060G70031A08	3 G 10	18,2	388	531	8
32060G70041A08	4 G 10	21,2	517	816	8
32060G70051A08	5 G 10	23,3	555	1005	8
32060G70071A08	7 G 10	25,5	750	1252	8
32060G70031A06	3 G 16	21,2	570	882	6
32060G70041A06	4 G 16	23,4	789	1107	6
32060G70051A06	5 G 16	26,2	799	1305	6
32060G70071A06	7 G 16	28,4	1216,5	1718	6
32060G70041A04	4 G 25	28,3	1101,5	1636	4
32060G70041A02	4 G 35	32,6	1505	2217	2

Other dimension and colours available on request.

CONTROL AND CONNECTION CABLES

GAALFLEX® TRAY 1002 CY Lean

Special PVC oil resistant, flexible tray cable, Machine-Tool cable,

with overall copper screen, acc. to UL 1277 (TC-ER) and UL 1063 (MTW), 600 V TC & MTW, 1000 V AWM & IEC



ELETTROTEK KABEL® GAALFLEX® TRAY 1002 CY lean

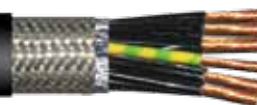

Construction:

Conductor:	flexible red copper conductor Cl. 5, acc to IEC 60228, DIN VDE 0295 and UL standard 83 from 18 to 16 AWG: cores type TFF from 14 AWG and over: cores type THHW
Insulation:	GAALTHERM® 522
Colour cores:	black cores with consecutive numbers acc. to EN 50334, green-yellow from 3 cores
Stranding:	in layers
Screen:	aluminium tape and tinned copper braid
Outer sheath:	black (RAL 9005), special PVC oil resistant compound acc. to UL 1277 and UL 1063

Technical data:

Nominal voltage:	UL-TC/MTW 600 V
Nominal voltage:	IEC / UL-AWM 1000 V
Test voltage:	4 kV
Temperature range	
<i>Fixed laying:</i>	- 40°C up to +90°C (UL-AWM up to +105°C)
<i>Flexible application:</i>	- 5°C up to +90°C (UL-AWM up to +105°C)
Min. bending radius:	
<i>Fixed laying:</i>	6 x d
<i>Flexible installation:</i>	20 x d

Resistance:



Fire performance acc. to:
(UL) FT4/IEEE, UL 1685



Oil resistance acc. to:
to UL OIL RES I



UV resistant / Sunlight resistant:
acc. to EN 50396 and HD 605 A1, UL 1581

Features:

AWM style 10012/21179 90°C 600 or 1000 V, CSA AWM I/II A/B
acc. to UL 1063 UL(MTW) and UL 1277 (TC-ER)
oil resistant acc. to UL OIL RES I,
water resistance and UL Wet approval 75°C
acc. to UL 2277: Flexible Motor Supply Lead Cable
(Flexible VFD Servo Cable) and Wind Turbine Tray Cable (WTTC)
acc. to NFPA 79 2007 and NEC 336.10(7)
class 1 Div. 2 art 336, 392, 501
Direct burial acc. to UL 1277 part. 5.2. (wet location insulations)
and 18.1 - 18.6 (crushing test)
outdoor use
exposed runs
cable for tray use
oil resistance
water resistance
RoHS and CE approval



CONTROL AND CONNECTION CABLES

GAALFLEX® TRAY 1002 CY Lean

Special PVC oil resistant, flexible tray cable, Machine-Tool cable,
with overall copper screen, acc. to UL 1277 (TC-ER) and UL 1063 (MTW), 600 VTC & MTW, 1000 V AWM & IEC



ELETTROTEK KABEL® GAALFLEX® TRAY 1002 CY lean

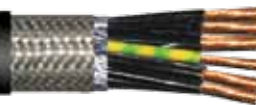

Part no.	No. of cores x cross section n x mm ²	Outer-Ø ca. mm ± 10%	Copper weight kg/km	Cable weight approx. kg/km	AWG no. *)
32240H71020A18	2 x 1	8,5	44,0	100	18
32240H70031A18	3 G 1	8,9	58,4	122	18
32240H70041A18	4 G 1	9,7	67,9	145	18
32240H70051A18	5 G 1	10,5	82,6	175	18
32240H70071A18	7 G 1	11,4	106,7	212	18
32240H70121A18	12 G 1	15,5	185,2	350	18
32240H70181A18	18 G 1	17,9	260,5	485	18
32240H70251A18	25 G 1	20,3	336,3	610	18
32240H71020A16	2 x 1,5	9,2	58,4	125	16
32240H70031A16	3 G 1,5	9,7	72,7	145	16
32240H70041A16	4 G 1,5	10,5	92,2	185	16
32240H70051A16	5 G 1,5	11,4	111,5	220	16
32240H70071A16	7 G 1,5	12,4	145,3	270	16
32240H70121A16	12 G 1,5	16,9	251,8	450	16
32240H70181A16	18 G 1,5	19,6	355,6	630	16
32240H70251A16	25 G 1,5	23,4	474,0	770	16
32240H71020A14	2 x 2,5	10,0	82,5	158	14
32240H70031A14	3 G 2,5	10,5	106,6	190	14
32240H70041A14	4 G 2,5	11,4	135,6	240	14
32240H70051A14	5 G 2,5	12,5	164,4	290	14
32240H70071A14	7 G 2,5	14,6	229,6	390	14
32240H70121A14	12 G 2,5	18,5	375,9	610	14
32240H70181A14	18 G 2,5	22,6	537,5	850	14
32240H70031A12	3 G 4	11,9	154,6	260	12
32240H70041A12	4 G 4	13,0	198,1	335	12
32240H70051A12	5 G 4	15,2	262,1	435	12
32240H70071A12	7 G 4	16,5	348,0	550	12
32240H70031A10	3 G 6	13,9	217,2	355	10
32240H70041A10	4 G 6	15,3	300,7	480	10
32240H70051A10	5 G 6	16,7	367,0	570	10
32240H70041A08	4 G 10	19,4	480,8	770	8
32240H70051A08	5 G 10	22,4	585,4	960	8
32240H70041A06	4 G 16	24,6	737,3	1210	6
32240H70051A06	5 G 16	27,1	899,7	1450	6
32240H70041A04	4 G 25	28,1	1100,6	1700	4
32240H70041A02	4 G 35	31,0	1502,0	2210	2
32240H70041A01	4 G 50	37,7	2166,7	3210	1
32240H70041A2C	4 G 70	44,2	2976,1	4400	2/0
32240H70041A3C	4 G 95	47,7	3963,5	5570	3/0
32240H70041A4C	4 G 120	50,3	4937,2	6660	4/0
32240H70041A5C	4 G 150	55,9	6130,5	8260	250 MCM

Other dimension and colours available on request.

CONTROL AND CONNECTION CABLES

GAALFLEX® TRAY INSTRUMENTATION 600 POS

Special paired XLPE/PVC UV and oil resistant, with overall Aluminium tape screen, TC-ER 90°C 600V Dry or wet, UL 1277 type TC



ELETTROTEK KABEL® GAALFLEX® INSTRUMENTATION 600 POS



Construction:

Conductor:	stranded red copper conductor similar Cl. 2, acc. to IEC 60228, ASTM B33 and B8
Insulation:	special XLPE compound flame-retardant
Colour cores:	acc. to ICEA table E1: pairs: black and white numbered
Stranding:	in pairs
Screen:	aluminium tape + PETP foil
Outer sheath:	black (RAL 9005), special PVC oil and UV resistance compound

Resistance:



Fire performance acc. to:
UL 1581 / IEEE 383



Low smoke emission acc. to:
UL 1685

Technical data:

Nominal voltage:	UL: 600V
Test voltage:	4 kV
Temperature range	UL: - 40°C up to +90°C
Min. bending radius:	
<i>Fixed laying:</i>	5 x d
<i>Flexible installation:</i>	8 x d

Features:

- on request tinned copper conductor
- on request flexible conductors
- on request Method 4 color code
- on request fire performance acc. to FT4 and IEEE 1202

UV and weather resistance
abrasion and chemical resistance

Type TC-ER UL 600V 90°C dry or wet
sunlight resistant oil resistant I direct burial

TC: UL Standard 1277

acc. to UL 1581

acc. to EPA 40 CFR, Part 261, Subpart C,
heavy metals per table 1, TCLP method

acc. to ICEA S-95-658 (WC70)

approved for class 1 div 2 hazardous location
acc. to NEC article 501 (TC)

acc. to NEC article 336 applications

RoHS and CE approval



Part no.	No. of pair(s) x cross section n x AWG	Outer-Ø ca. mm ± 10%	Copper weight Lbs/Mft - kg/km	Cable weight approx. Lbs/Mft - kg/km
32090F7T012A18	1 x 2 x 18	0,314 - 7,98	-	45 - 67
32090F7T022A18	2 x 2 x 18	0,476 - 12,09	-	89 - 132
32090F7T042A18	4 x 2 x 18	0,582 - 14,78	-	156 - 132
32090F7T082A18	8 x 2 x 18	0,733 - 18,61	-	255 - 380
32090F7T122A18	12 x 2 x 18	0,902 - 22,91	-	383 - 570
32090F7T242A18	24 x 2 x 18	1,198 - 30,43	-	665 - 990
32090F7T362A18	36 x 2 x 18	1,360 - 34,54	-	909 - 1353
32090F7T012A16	1 x 2 x 16	0,338 - 8,59	-	56 - 83
32090F7T022A16	2 x 2 x 16	0,548 - 13,92	-	184 - 274
32090F7T042A16	4 x 2 x 16	0,632 - 16,05	-	218 - 324
32090F7T082A16	8 x 2 x 16	0,800 - 20,32	-	328 - 488
32090F7T122A16	12 x 2 x 16	0,988 - 25,10	-	496 - 738
32090F7T162A16	16 x 2 x 16	1,108 - 28,14	-	625 - 930
32090F7T242A16	24 x 2 x 16	1,312 - 33,32	-	869 - 1293
32090F7T362A16	36 x 2 x 16	1,530 - 38,86	-	1258 - 1872

Other dimension and colours available on request.

CONTROL AND CONNECTION CABLES

GAALFLEX® TRAY INSTRUMENTATION 600 SPOS

Special paired XLPE/PVC UV and oil resistant, with individual and overall Aluminium tape screen, TC-ER 90°C 600V Dry or wet, UL 1277 type TC



ELETTROTEK KABEL® GAALFLEX® INSTRUMENTATION 600 SPOS



Construction:

Conductor:	stranded red copper conductor similar Cl. 2, acc. to IEC 60228, ASTM B33 and B8
Insulation:	special XLPE compound flame-retardant
Colour cores:	acc. to ICEA table E1: pairs: black and white numbered
Stranding:	in pairs
Screen	
<i>Individual:</i>	aluminium tape + PETP foil on each pair
<i>Overall:</i>	aluminium tape + PETP foil
Outer sheath:	black (RAL 9005), special PVC oil and UV resistance compound

Resistance:



Fire performance acc. to:
UL 1581 / IEEE 383



Low smoke emission acc. to:
UL 1685

Technical data:

Nominal voltage:	UL: 600V
Test voltage:	4 kV
Temperature range	UL: - 40°C up to +90°C
Min. bending radius:	
<i>Fixed laying:</i>	5 x d
<i>Flexible installation:</i>	8 x d

Features:

- on request tinned copper conductor
- on request flexible conductors
- on request Method 4 color code
- on request fire performance acc. to FT4 and IEEE 1202
- UV and weather resistance
- abrasion and chemical resistance
- Type TC-ER UL 600V 90°C dry or wet
- sunlight resistant oil resistant I direct burial
- TC: UL Standard 1277
- acc. to UL 1581
- acc. to EPA 40 CFR, Part 261, Subpart C, heavy metals per table 1, TCLP method
- acc. to ICEA S-95-658 (WC70)
- approved for class 1 div 2 hazardous location
- acc. to NEC article 501 (TC)
- acc. to NEC article 336 applications
- RoHS and CE approval



Part no.	No. of triads x cross section n x AWG	Outer-Ø ca. mm ± 10%	Copper weight Lbs/Mft - kg/km	Cable weight approx. Lbs/Mft - kg/km
32100F7T022A18	2 x 2 x 18	0,490 - 12,45	-	98 - 146
32100F7T042A18	4 x 2 x 18	0,598 - 15,19	-	176 - 262
32100F7T082A18	8 x 2 x 18	0,755 - 19,18	-	290 - 432
32100F7T122A18	12 x 2 x 18	0,930 - 23,62	-	438 - 652
32100F7T242A18	24 x 2 x 18	1,254 - 31,85	-	796 - 1185
32100F7T362A18	36 x 2 x 18	1,442 - 36,63	-	968 - 1440
32100F7T022A16	2 x 2 x 16	0,562 - 14,27	-	140 - 208
32100F7T042A16	4 x 2 x 16	0,674 - 17,07	-	227 - 338
32100F7T082A16	8 x 2 x 16	0,800 - 20,32	-	375 - 558
32100F7T122A16	12 x 2 x 16	1,015 - 25,78	-	571 - 850
32100F7T242A16	24 x 2 x 16	1,368 - 34,75	-	1044 - 1554
32100F7T362A16	36 x 2 x 16	1,574 - 39,98	-	1477 - 2198

Other dimension and colours available on request.

CONTROL AND CONNECTION CABLES

GAALFLEX® TRAY INSTRUMENTATION 600 TOS

Special triads XLPE/PVC UV and oil resistant, with overall Aluminium tape screen, TC-ER 90°C 600V Dry or wet, UL 1277 type TC



ELETTROTEK KABEL® GAALFLEX® INSTRUMENTATION 600 TOS



Construction:

Conductor:	stranded red copper conductor similar Cl. 2, acc. to IEC 60228, ASTM B33 and B8
Insulation:	special XLPE compound flame-retardant
Colour cores:	acc. to ICEA table E1: triads: black, white and red numbered
Stranding:	in triads
Screen:	aluminium tape + PETP foil
Outer sheath:	black (RAL 9005), special PVC oil and UV resistance compound

Resistance:



Fire performance acc. to:
UL 1581 / IEEE 383



Low smoke emission acc. to:
UL 1685

Technical data:

Nominal voltage:	UL: 600V
Test voltage:	4 kV
Temperature range	UL: - 40°C up to +90°C
Min. bending radius:	
<i>Fixed laying:</i>	5 x d
<i>Flexible installation:</i>	8 x d

Features:

- on request tinned copper conductor
- on request flexible conductors
- on request acc. to Method 4 color coded
- on request fire performance acc. to FT4 and IEEE 1202
- UV and weather resistance
abrasion and chemical resistance
- Type TC-ER UL 600V 90°C dry or wet
sunlight resistant oil resistant | direct burial
- TC: UL Standard 1277
- acc. to UL 1581
- acc. to EPA 40 CFR, Part 261, Subpart C,
heavy metals per table 1, TCLP method
- acc. to ICEA S-95-658 (WC70)
- approved for class 1 div 2 hazardous location
acc. to NEC article 501 (TC)
- acc. to NEC article 336 applications
- RoHS and CE approval



Part no.	No. of triads x cross section n x AWG	Outer-Ø ca. mm ± 10%	Copper weight Lbs/Mft - kg/km	Cable weight approx. Lbs/Mft - kg/km
32110F7T023A18	2 x 3 x 18	0,604 - 15,34	-	138 - 206
32110F7T043A18	4 x 3 x 18	0,703 - 17,86	-	228 - 339
32110F7T083A18	8 x 3 x 18	0,903 - 22,91	-	388 - 577
32110F7T123A18	12 x 3 x 18	1,142 - 29,01	-	596 - 887
32110F7T163A18	16 x 3 x 18	1,330 - 33,78	-	807 - 1200
32110F7T243A18	24 x 3 x 18	1,632 - 41,45	-	1133 - 1685
32110F7T363A18	36 x 3 x 18	1,869 - 47,47	-	1586 - 2360
32110F7T023A16	2 x 3 x 16	0,656 - 16,66	-	156 - 232
32110F7T043A16	4 x 3 x 16	0,780 - 19,81	-	291 - 433
32110F7T083A16	8 x 3 x 16	1,028 - 26,11	-	545 - 811
32110F7T123A16	12 x 3 x 16	1,271 - 32,28	-	735 - 1094
32110F7T163A16	16 x 3 x 16	1,452 - 36,88	-	973 - 1448
32110F7T243A16	24 x 3 x 16	1,808 - 45,92	-	1516 - 2256
32110F7T363A16	36 x 3 x 16	2,071 - 52,60	-	2136 - 3178

Other dimension and colours available on request.

CONTROL AND CONNECTION CABLES

GAALFLEX® TRAY INSTRUMENTATION 600 STOS

Special triads XLPE/PVC UV and oil resistant, with individual and overall Aluminium tape screen, TC-ER 90°C 600V Dry or wet, UL 1277 type TC



ELETTROTEK KABEL® GAALFLEX® INSTRUMENTATION 600 STOS



Construction:

Conductor:	stranded red copper conductor similar Cl. 2, acc. to IEC 60228, ASTM B33 and B
Insulation:	special XLPE compound flame-retardant
Colour cores:	acc. to ICEA table E1: triads: black, white and red numbered
Stranding:	in triads
Screen	
<i>Individual:</i>	aluminium tape + PETP foil on each pair
<i>Overall:</i>	aluminium tape + PETP foil
Outer sheath:	black (RAL 9005), special PVC oil and UV resistance compound

Resistance:



Fire performance acc. to:
UL 1581 / IEEE 383



Low smoke emission acc. to:
UL 1685

Technical data:

Nominal voltage:	UL: 600V
Test voltage:	4 kV
Temperature range	UL: - 40°C up to +90°C
Min. bending radius:	
<i>Fixed laying:</i>	5 x d
<i>Flexible installation:</i>	8 x d

Features:

on request tinned copper conductor
on request flexible conductors
on request Method 4 color code
on request fire performance acc. to FT4 and IEEE 1202

UV and weather resistance
abrasion and chemical resistance

Type TC-ER UL 600V 90°C dry or wet
sunlight resistant oil resistant I direct burial

TC: UL Standard 1277
acc. to UL 1581

acc. to EPA 40 CFR, Part 261, Subpart C,
heavy metals per table 1, TCLP method

acc. to ICEA S-95-658 (WC70)

approved for class 1 div 2 hazardous location
acc. to NEC article 501 (TC)

acc. to NEC article 336 applications

RoHS and CE approval



Part no.	No. of triads x cross section n x AWG	Outer-Ø ca. mm ± 10%	Copper weight Lbs/Mft - kg/km	Cable weight approx. Lbs/Mft - kg/km
32120F7T013A18	1 x 3 x 18	0,331 - 8,41	-	59 - 75
32120F7T013A16	1 x 3 x 16	0,357 - 9,07	-	75 - 94
32120F7T013A14	1 x 3 x 14	0,387 - 9,83	-	98 - 146

Other dimension and colours available on request.

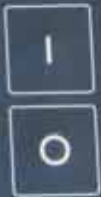
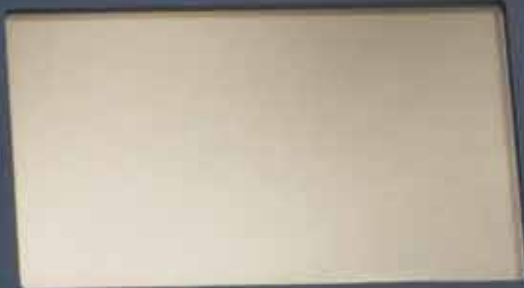

GAALFLEX® VFD CABLES



GAALFLEX® VFD 2YSLCY-J

Inverter, connection to frequency converters, 0,6/1 kV



Construction:

Conductor:	flexible red copper conductor Cl. 5, acc to IEC 60228, DIN VDE 0295
Insulation:	PE compound
Cores color:	acc. to DIN VDE 0293-308, HD 308 S2 3 conductors + 3 earth conductors: grey, brown, black and green/yellow divided in interstices 4 cores: green/yellow, brown, black, grey
Stranding:	in layers
Screen:	aluminium tape + PETP foil and tinned copper braid
Outer Sheath:	transparent, PVC compound (4 conductors), transparent-orange, PVC compound (3 + 3G/Y conductor version)

Resistance:



Self-extinguishing and flame retardant acc. to:
DIN VDE 0482 part 265-2-1,
EN 50265-2-1,
IEC 60332-1-2

Technical data:

Nominal voltage:	U ₀ /U 0,6/1 kV
Test voltage:	4 kV
Max. operating voltage:	A.C. and 3 phase 0,7/1,2 kV D.C. operation 0,9/1,8 kV
Peak value \hat{U}:	1,7 kV
Temperature range	
<i>Fixed laying:</i>	- 40 °C up to + 70 °C
<i>Flexible application:</i>	- 5 °C up to + 70 °C
Max. temperature on conductor:	+ 90°C
Max. temperature in short circuit:	+ 250 °C
Min. bending radius	
<i>Fixed laying:</i>	up to 12 mm: 5 x d > 12 to 20 mm: 7,5 x d > 20 mm: 10 x d
<i>Flexible application:</i>	up to 12 mm: 10 x d > 12 to 20 mm: 15 x d > 20 mm: 2 0 x d
Insulation resistance:	min. 200 MOhm x km
Radiation resistance:	up to 80x10 ⁶ cJ/kg
Coupling resistance:	depending on the cross-section: max. 250 Ohm/km
Mutual capacitance (4 conductors version):	depending on the cross-section core/core 70 to 250 nF/km core/screen 110 to 410 nF/km

Features:

installation in hazardous areas
acc. to DIN VDE 0250
EMC (electromagnetic compatibility)
acc. to EN 55011 and DIN VDE 0875 part 11
low mutual capacitance
low coupling resistance
RoHS and CE approval

On request is possible:

2XSLCH-J Halogen-free Version

Insulation: XLPE special compound, acc. to IEC 60502-4 (max. core temperature + 90°C)

Outer Sheath: special type SHF1 (HM2)
acc. to IEC 60092-353



Applications:

suitable for motor power supply for the frequency converters, used in automotive and food industry, packaging industry, machine tools and handling equipment

GAALFLEX® VFD CABLES

GAALFLEX® VFD 2YSLCY-J

Inverter, connection to frequency converters, 0,6/1 kV



Part no.	No. of cores x cross section n x mm ²	Outer-Ø ca. mm ± 10%	Copper weight kg/km	Cable weight approx. kg/km	AWG no. *)
33010GT2041M15	4 G 1,5	11,1	95	226	16
33010GT2041M25	4 G 2,5	12,5	150	290	14
33010GT2041M40	4 G 4	14,2	235	444	12
33010GT2041M60	4 G 6	16	320	569	10
33010GT2041M61	4 G 10	19,5	533	803	8
33010GT2041M62	4 G 16	22	789	1195	6
33010GT2041M63	4 G 25	26	1236	1710	4
33010GT2041M64	4 G 35	28,8	1662	2390	2
33010GT2041M65	4 G 50	33,6	2345	2867	1
33010GT2041M66	4 G 70	38,7	3196	3830	2/0
33010GT2041M67	4 G 95	42,9	4316	5010	3/0
33010GT2041M68	4 G 120	48	5435	6227	4/0
33010GT2041M69	4 G 150	54	6394	7002	250 MCM
33010GT2041M70	4 G 185	59	7639	8347	350 MCM
33010GT2041M71	4 G 240	67	10013	10989	450 MCM
33010GT2041M72	4 G 300	71,5	12570	13800	550 MCM
33010GS2037M15	3 x 1,5 + 3 G 0,25	10,2	89	195	16 / 22
33010GS2037M25	3 x 2,5 + 3 G 0,5	11,5	144	240	14 / 20
33010GS2037M40	3 x 4 + 3 G 0,75	12,9	224	373	12 / 19
33010GS2037M60	3 x 6 + 3 G 1	15	298	480	10 / 18
33010GS2037M61	3 x 10 + 3 G 1,5	18,7	491	650	8 / 16
33010GS2037M62	3 x 16 + 3 G 2,5	21,1	723	871	6 / 14
33010GS2037M63	3 x 25 + 3 G 4	25,2	1138	1328	4 / 12
33010GS2037M64	3 x 35 + 3 G 6	27,7	1535	1799	2 / 10
33010GS2037M65	3 x 50 + 3 G 10	32	2182	2555	1 / 8
33010GS2037M66	3 x 70 + 3 G 10	36,3	2871	3170	2/0 / 8
33010GS2037M67	3 x 95 + 3 G 16	40,2	3953	4319	3/0 / 6
33010GS2037M68	3 x 120 + 3 G 16	44,7	4836	5154	4/0 / 6
33010GS2037M69	3 x 150 + 3 G 25	50	5412	6687	250 MCM / 4
33010GS2037M70	3 x 185 + 3 G 35	55,2	7023	8211	350 MCM / 2
33010GS2037M71	3 x 240 + 3 G 42,5	61,1	8808	9733	450 MCM / 1
33010GS2037M72	3 x 300 + 3 G 50	69	11050	13450	550 MCM / 1

Other dimension and colours available on request.

GAALFLEX® VFD 2YSLCYK-J

Inverter, connection to frequency converters, UV Resistant, 0,6/1 kV



Construction:

Conductor:	flexible red copper conductor Cl. 5, acc to IEC 60228, DIN VDE 0295
Insulation:	PE compound
Cores color:	acc. to DIN VDE 0293-308, HD 308 S2 3 conductors + 3 earth conductors: grey, brown, black and green/yellow divided in interstices 4 cores: green/yellow, brown, black, grey
Stranding:	in layers
Screen:	aluminium tape + PETP foil and tinned copper braid
Outer Sheath:	black (similar RAL 9005), PVC compound

Resistance:



Self-extinguishing and flame retardant acc. to:
DIN VDE 0482 part 265-2-1,
EN 50265-2-1,
IEC 60332-1-2

Technical data:

Nominal voltage:	U ₀ /U 0,6/1 kV
Test voltage:	4 kV
Max. operating voltage:	A.C. and 3 phase 0,7/1,2 kV D.C. operation 0,9/1,8 kV
Peak value \hat{U}:	1,7 kV
Temperature range	
<i>Fixed laying:</i>	- 40 °C up to + 70 °C
<i>Flexible installation:</i>	- 5 °C up to + 70 °C
Max. temperature on conductor:	+ 90°C
Max. temperature in short circuit:	+ 250 °C
Min. bending radius:	
<i>Fixed laying:</i>	up to 12 mm: 5 x d > 12 to 20 mm: 7,5 x d > 20 mm: 10 x d
<i>Flexible application:</i>	up to 12 mm: 10 x d > 12 to 20 mm: 15 x d > 20 mm: 20 x d
Insulation resistance:	min. 200 MOhm x km
Radiation resistance:	up to 80x10 ⁶ cJ/kg
Coupling resistance:	depending on the cross-section: max. 250 Ohm/km
Mutual capacitance (4 conductors version):	depending on the cross-section core/core 70 to 250 nF/km core/screen 110 to 410 nF/km

Features:

Suitable for Mining applications!

UV resistant
outdoor use
acc. to DIN VDE 0250
EMC (electromagnetic compatibility)
acc. to EN 55011 and DIN VDE 0875 part 11
low mutual capacitance
low coupling resistance
RoHS and CE approval

On request is possible:
2XSLCHK-J Halogen-free Version
Insulation: XLPE special compound. acc. to IEC 60502-4
(max. core temperature + 90°C)
Outer Sheath: special type SHF1 (HM2)
acc. to IEC 60092-353



Applications:

suitable for motor power supply for the frequency converters, used in automotive and food industry, packaging industry, machine tools and handling equipment

GAALFLEX® VFD CABLES

GAALFLEX® VFD 2YSLCYK-J

Inverter, connection to frequency converters, UV Resistant, 0,6/1 kV

ELETTROTEK KABEL® GAALFLEX® VFD 2YSLCYK-J



ELETTROTEK KABEL® GAALFLEX® VFD 2YSLCYK-J



Part no.	No. of cores x cross section n x mm ²	Outer-Ø ca. mm ± 10%	Copper weight kg/km	Cable weight approx. kg/km	AWG no. *)
33020G72041M15	4 G 1,5	11,1	95	226	16
33020G72041M25	4 G 2,5	12,5	150	290	14
33020G72041M40	4 G 4	14,5	235	444	12
33020G72041M60	4 G 6	15,9	320	569	10
33020G72041M61	4 G 10	19,5	533	813	8
33020G72041M62	4 G 16	22,1	789	1195	6
33020G72041M63	4 G 25	25,9	1236	1710	4
33020G72041M64	4 G 35	28,8	1662	2390	2
33020G72041M65	4 G 50	33,7	2345	2867	1
33020G72041M66	4 G 70	38,7	3196	3830	2/0
33020G72041M67	4 G 95	42,9	4316	5023	3/0
33020G72041M68	4 G 120	48,1	5435	6243	4/0
33020G72041M69	4 G 150	54	6394	7015	250 MCM
33020G72041M70	4 G 185	59	7639	8362	350 MCM
33020G72041M71	4 G 240	67	10013	11036	450 MCM
33020G72041M72	4 G 300	71,5	12570	13800	550 MCM
33020G72037M15	3 x 1,5 + 3 G 0,25	10,8	89	195	16 / 22
33020G72037M25	3 x 2,5 + 3 G 0,5	12,2	144	240	14 / 20
33020G72037M40	3 x 4 + 3 G 0,75	13,9	224	373	12 / 19
33020G72037M60	3 x 6 + 3 G 1	15	298	480	10 / 18
33020G72037M61	3 x 10 + 3 G 1,5	18,7	491	650	8 / 16
33020G72037M62	3 x 16 + 3 G 2,5	21,2	723	871	6 / 14
33020G72037M63	3 x 25 + 3 G 4	25,3	1137	1328	4 / 12
33020G72037M64	3 x 35 + 3 G 6	27,7	1535	1799	2 / 10
33020G72037M65	3 x 50 + 3 G 10	32,1	2182	2555	1 / 8
33020G72037M66	3 x 70 + 3 G 10	36,3	2871	3170	2/0 / 8
33020G72037M67	3 x 95 + 3 G 16	40,3	3953	4319	3/0 / 6
33020G72037M68	3 x 120 + 3 G 16	44,7	4836	5154	4/0 / 6
33020G72037M69	3 x 150 + 3 G 25	50	5412	6687	250 MCM / 4
33020G72037M70	3 x 185 + 3 G 35	54,9	7023	8211	350 MCM / 2
33020G72037M71	3 x 240 + 3 G 50	60,8	8808	9733	450 MCM / 1
33020G72037M72	3 x 300 + 3 G 50	69	11050	13450	550 MCM / 1

Other dimension and colours available on request.

GAALFLEX® VFD 1000 (2YSLCYK-J UL)

Inverter, connection to frequency converters, UV Resistant, 0,6/1 kV



ELETTROTEK KABEL® GAALFLEX® VFD 1000 (2YSLCYK-J UL)
 AWM Style 2570 1000V 80°C VW-1
 AWM III A/B 1000 V 80° FT-1



ELETTROTEK KABEL® GAALFLEX® VFD 1000 (2YSLCYK-J UL)
 AWM Style 2570 1000V 80°C VW-1
 AWM III A/B 1000 V 80° FT-1



Construction:

Conductor:	flexible red copper conductor Cl. 5, acc to IEC 60228, DIN VDE 0295
Insulation:	PE compound
Cores color:	acc. to DIN VDE 0293-308, HD 308 S2 3 conductors + 3 earth conductors: grey, brown, black and green/yellow divided in interstices 4 cores: green/yellow, brown, black, grey
Stranding:	in layers
Screen:	aluminium tape + PETP foil and tinned copper braid
Outer Sheath:	black (similar RAL 9005), PVC compound

Resistance:



Self-extinguishing and flame retardant acc. to:
 DIN VDE 0482 part 265-2-1,
 EN 50265-2-1,
 IEC 60332-1-2

Technical data:

Nominal voltage:	U ₀ /U 0,6/1 kV
Nominal voltage UL:	1000 V
Test voltage:	4 kV
Max. operating voltage:	A.C. and 3 phase 0,7/1,2 kV D.C. operation 0,9/1,8 kV
Peak value \hat{U}:	1,7 kV
Temperature range	
<i>Fixed laying:</i>	- 40 °C up to + 70 °C
<i>Flexible installation:</i>	- 5 °C up to + 70 °C
Temperature range UL:	
<i>Fixed laying:</i>	+ 80 °C
<i>Flexible application:</i>	+ 80 °C
Max. temperature on conductor:	+ 90°C
Max. temperature in short circuit:	+ 250 °C
Min. bending radius	
<i>Fixed laying:</i>	up to 12 mm: 5 x d > 12 to 20 mm: 7,5 x d > 20 mm: 10 x d
<i>Flexible installation:</i>	up to 12 mm: 10 x d > 12 to 20 mm: 15 x d > 20 mm: 20 x d
Insulation resistance:	min. 200 MOhm x km
Radiation resistance:	up to 80x10 ⁶ cJ/kg
Coupling resistance:	depending on the cross-section: max. 250 Ohm/km
Mutual capacitance (4 conductors version):	depending on the cross-section core/core 70 to 250 nF/km core/screen 110 to 410 nF/km

Features:

- UV resistant
- outdoor use
- acc. to DIN VDE 0250
- EMC (electromagnetic compatibility)
- acc. to EN 55011 and DIN VDE 0875 part 11
- low mutual capacitance
- low coupling resistance
- AWM Style 2570 1000 V 80°C VW-1
- AWM III A/B 1000 V 80° FT-1

RoHS and CE approval



Applications:

suitable for motor power supply for the frequency converters, used in automotive and food industry, packaging industry, machine tools and handling equipment

GAALFLEX® VFD CABLES

GAALFLEX® VFD 1000 (2YSLCYK-J UL)

Inverter, connection to frequency converters, UV Resistant, 0,6/1 kV

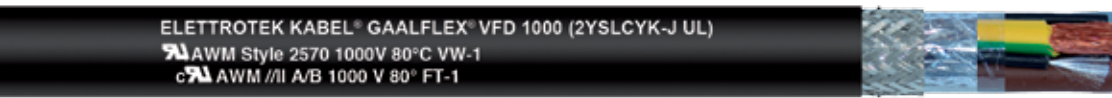

Part no.	No. of cores x cross section n x mm ²	Outer-Ø ca. mm ± 10%	Copper weight kg/km	Cable weight approx. kg/km	AWG no. *)
33150H72041A16	4 G 1,5	10,4	95	230	16
33150H72041A14	4 G 2,5	12,5	150	300	14
33150H72041A12	4 G 4	14,2	235	485	12
33150H72041A10	4 G 6	15,2	320	630	10
33150H72041A08	4 G 10	19,5	533	860	8
33150H72041A06	4 G 16	22,9	789	1290	6
33150H72041A04	4 G 25	27,1	1236	1860	4
33150H72041A02	4 G 35	29,6	1662	2610	2
33150H72041A01	4 G 50	35,2	2345	2950	1
33150H72041A2C	4 G 70	41,4	3196	3950	2/0
33150H72041A3C	4 G 95	46,0	4316	5300	3/0
33150H72041A4C	4 G 120	50,8	5435	6600	4/0
33150H72041A5C	4 G 150	58,3	6394	7040	250 MCM
33150H72041A7C	4 G 185	65,5	7639	8380	350 MCM
33150H72041A9C	4 G 240	67,0	10013	11010	450 MCM
33150H72041ABC	4 G 300	71,5	12570	13800	550 MCM
33150H72037A16	3 x 1,5 + 3 G 0,25	10	86	140	16 / 22
33150H72037A14	3 x 2,5 + 3 G 0,5	11,4	144	220	14 / 20
33150H72037A12	3 x 4 + 3 G 0,75	13	224	323	12 / 19
33150H72037A10	3 x 6 + 3 G 1	15	298	420	10 / 18
33150H72037A08	3 x 10 + 3 G 1,5	18,4	491	615	8 / 16
33150H72037A06	3 x 16 + 3 G 2,5	21	723	819	6 / 14
33150H72037A04	3 x 25 + 3 G 4	25,3	1138	1325	4 / 12
33150H72037A02	3 x 35 + 3 G 6	27,8	1535	1718	2 / 10
33150H72037A01	3 x 50 + 3 G 10	32,6	2208	2399	1 / 8
33150H72037A2C	3 x 70 + 3 G 10	38,1	2871	3056	2/0 / 8
33150H72037A3C	3 x 95 + 3 G 16	41	3953	4162	3/0 / 6
33150H72037A4C	3 x 120 + 3 G 16	46,4	4836	5075	4/0 / 6
33150H72037A5C	3 x 150 + 3 G 25	53,5	5412	6128	250 MCM / 4
33150H72037A7C	3 x 185 + 3 G 35	59,5	6969	7189	350 MCM / 2
33150H72037A9C	3 x 240 + 3 G 42,5	65,1	8540	9540	450 MCM / 1
33150H72037ABC	3 x 300 + 3 G 50	69,5	11050	11560	550 MCM / 1

Other dimension and colours available on request.

GAALFLEX® VFD I 300 A

Inverter, connection to frequency converters, UV Resistant, acc. to BS 5467



Construction:

Conductor:	flexible red copper conductor Cl. 5, acc to IEC 60228, DIN VDE 0295
Insulation:	GAALTHERM® 580
Cores color:	acc. to DIN VDE 0293-308, HD 308 S2 3 conductors + 3 earth conductors: grey, brown, black and green/yellow divided in interstices 4 cores: green/yellow, brown, black, grey
Stranding:	in layers
Screen:	aluminium tape + PETP foil and tinned copper braid
Inner Sheath:	black (RAL 9005), special PVC compound
Armouring:	steel wires
Outer Sheath:	black (similar RAL 9005), special PVC compound

Resistance:



Self-extinguishing and flame retardant acc. to:
DIN VDE 0482 part 265-2-1,
EN 50265-2-1,
IEC 60332-1-2

Technical data:

Nominal voltage:	U ₀ /U 0,6/1 kV
Test voltage:	4 kV
Max. operating voltage:	A.C. and 3 phase 0,7/1,2 kV D.C. operation 0,9/1,8 kV
Peak value \hat{U}:	1,7 kV
Temperature range	
<i>Fixed laying:</i>	- 40 °C up to + 70 °C
<i>Flexible installation:</i>	- 5 °C up to + 70 °C
Max. temperature on conductor:	+ 90°C
Max. temperature in short circuit:	+ 250 °C
Min. bending radius:	12 x d
Insulation resistance:	min. 200 MOhm x km
Radiation resistance:	up to 80x10 ⁸ cJ/kg
Coupling resistance:	depending on the cross-section: max. 250 Ohm/km
Mutual capacitance (4 conductors version):	depending on the cross-section core/core 70 to 250 nF/km core/screen 110 to 410 nF/km

Features:

UV resistant
outdoor use
acc. to DIN VDE 0250
EMC (electromagnetic compatibility)
acc. to EN 55011 and DIN VDE 0875 part 11
low mutual capacitance
low coupling resistance
acc. to BS 5467
RoHS and CE approval



GAALFLEX® VFD CABLES

GAALFLEX® VFD I 300 A

Inverter, connection to frequency converters, UV Resistant, acc. to BS 5467



Part no.	No. of cores x cross section n x mm ²	Outer-Ø ca. mm ± 10%	Copper weight kg/km	Cable weight approx. kg/km	AWG no. *)
33030G72041M15	4 G 1,5	12,2	95	265	16
33030G72041M25	4 G 2,5	14,1	150	345	14
33030G72041M40	4 G 4	16,7	235	560	12
33030G72041M60	4 G 6	16,4	320	730	10
33030G72041M61	4 G 10	18,9	533	995	8
33030G72041M62	4 G 16	26,9	789	1485	6
33030G72041M63	4 G 25	31	1236	2145	4
33030G72041M64	4 G 35	35,3	1662	3000	2
33030G72041M65	4 G 50	41,5	2345	3400	1
33030G72041M66	4 G 70	48,6	3196	4550	2/0
33030G72041M67	4 G 95	54,9	4316	6100	3/0
33030G72041M68	4 G 120	59,7	5435	7600	4/0
33030G72041M69	4 G 150	66,1	6394	8100	250 MCM
33030G72041M70	4 G 185	70,3	7639	9640	350 MCM
33030G72041M71	4 G 240	77,1	10013	12660	450 MCM
33030G72041M72	4 G 300	82,2	12570	15870	550 MCM
33030G72037M15	3 x 1,5 + 3 G 0,25	11,7	86	160	16 / 22
33030G72037M25	3 x 2,5 + 3 G 0,5	13,1	144	255	14 / 20
33030G72037M40	3 x 4 + 3 G 0,75	15	224	371	12 / 19
33030G72037M60	3 x 6 + 3 G 1	17,2	298	485	10 / 18
33030G72037M61	3 x 10 + 3 G 1,5	21,2	491	710	8 / 16
33030G72037M62	3 x 16 + 3 G 2,5	24,9	723	819	6 / 14
33030G72037M63	3 x 25 + 3 G 4	29,1	1138	945	4 / 12
33030G72037M64	3 x 35 + 3 G 6	32	1535	1975	2 / 10
33030G72037M65	3 x 50 + 3 G 10	37,5	2208	2760	1 / 8
33030G72037M66	3 x 70 + 3 G 10	44,9	2871	3514	2/0 / 8
33030G72037M67	3 x 95 + 3 G 16	50,9	3953	4790	3/0 / 6
33030G72037M68	3 x 120 + 3 G 16	53,2	4836	5835	4/0 / 6
33030G72037M69	3 x 150 + 3 G 25	61,5	5412	7050	250 MCM / 4
33030G72037M70	3 x 185 + 3 G 35	68,4	6969	8270	350 MCM / 2
33030G72037M71	3 x 240 + 3 G 42,5	75	8540	10975	450 MCM / 1
33030G72037M72	3 x 300 + 3 G 50	79,9	11050	13295	550 MCM / 1

Other dimension and colours available on request.

GAALFLEX® VFD 2XSLCYK-J

Inverter, connection to frequency converters, UV Resistant, 0,6/1 kV

ELETTROTEK KABEL® GAALFLEX® VFD 2XSLCYK-J



ELETTROTEK KABEL® GAALFLEX® VFD 2XSLCYK-J



Construction:

Conductor:	flexible red copper conductor Cl. 5, acc to IEC 60228, DIN VDE 0295
Insulation:	special XLPE compound
Cores color:	acc. to DIN VDE 0293-308, HD 308 S2 3 conductors + 3 earth conductors: grey, brown, black and green/yellow divided in interstices 4 cores: green/yellow, brown, black, grey
Stranding:	in layers
Screen:	aluminium tape + PETP foil and tinned copper braid
Outer Sheath:	black (similar RAL 9005), special PVC compound

Resistance:



Self-extinguishing and flame retardant acc. to:
DIN VDE 0482 part 265-2-1,
EN 50265-2-1,
IEC 60332-1-2

Technical data:

Nominal voltage:	U ₀ /U 0,6/1 kV
Test voltage:	4 kV
Max. operating voltage:	A.C. and 3 phase 0,7/1,2 kV D.C. operation 0,9/1,8 kV
Peak value \hat{U}:	1,7 kV
Temperature range	
<i>Fixed laying:</i>	- 40 °C up to + 70 °C
<i>Flexible installation:</i>	- 15 °C up to + 70 °C
Max. temperature on conductor:	+ 90°C
Max. temperature in short circuit:	+ 250 °C
Min. bending radius	
<i>Fixed laying:</i>	up to 12 mm: 5 x d > 12 to 20 mm: 7,5 x d > 20 mm: 10 x d
<i>Flexible application:</i>	up to 12 mm: 10 x d > 12 to 20 mm: 15 x d > 20 mm: 20 x d
Insulation resistance:	min. 200 MOhm x km
Radiation resistance:	up to 80x10 ⁶ cJ/kg
Coupling resistance:	depending on the cross-section: max. 250 Ohm/km
Mutual capacitance (4 conductors version):	depending on the cross-section core/core 70 to 250 nF/km core/screen 110 to 410 nF/km

Features:

Suitable for Mining applications!

- UV resistant
- outdoor use
- acc. to DIN VDE 0250
- EMC (electromagnetic compatibility)
- acc. to EN 55011 and DIN VDE 0875 part 11
- low mutual capacitance
- low coupling resistance
- installation in hazardous areas
- low coupling resistance for high electromagnetic compatibility
- RoHS and CE approval



Applications:

suitable in plants and buildings, as a supply and connecting cable for medium mechanical stresses in fixed installations and forced movements in dry, moist and wet environments for outdoor applications. Used in the automobile industry, food industry, environmental engineering, packaging industry, toolmaking machinery, handling equipment, for SIMOVERT drivers, they are particularly suitable for use with industrial pumps, ventilators, conveyor belts and air-conditioning installations and similar applications.

GAALFLEX® VFD CABLES

GAALFLEX® VFD 2XSLCYK-J

Inverter, connection to frequency converters, UV Resistant, 0,6/1 kV

ELETTROTEK KABEL® GAALFLEX® VFD 2XSLCYK-J



ELETTROTEK KABEL® GAALFLEX® VFD 2XSLCYK-J



Part no.	No. of cores x cross section n x mm ²	Outer-Ø ca. mm ± 10%	Copper weight kg/km	Cable weight approx. kg/km	AWG no. *)
33040G72041M15	4 G 1,5	11,3	95	230	16
33040G72041M25	4 G 2,5	12,4	150	300	14
33040G72041M40	4 G 4	13,6	235	485	12
33040G72041M60	4 G 6	14,8	320	630	10
33040G72041M61	4 G 10	17,5	533	860	8
33040G72041M62	4 G 16	20,2	789	1290	6
33040G72041M63	4 G 25	24,8	1236	1860	4
33040G72041M64	4 G 35	27,4	1662	2610	2
33040G72041M65	4 G 50	32,0	2345	2950	1
33040G72041M66	4 G 70	37,1	3196	3950	2/0
33040G72041M67	4 G 95	41,6	4316	5300	3/0
33040G72041M68	4 G 120	45,2	5435	6600	4/0
33040G72041M69	4 G 150	52,0	6394	7040	250 MCM
33040G72041M70	4 G 185	58,1	7639	8380	350 MCM
33040G72041M71	4 G 240	66,1	10020	11300	450 MCM
33040G72041M72	4 G 300	71,5	12570	13800	550 MCM
33040G72037M15	3 x 1,5 + 3 G 0,25	12	91	234	16 / 24
33040G72037M25	3 x 2,5 + 3 G 0,5	13	152	282	14 / 20
33040G72037M40	3 x 4 + 3 G 0,75	14	224	447	12 / 19
33040G72037M60	3 x 6 + 3 G 1	16	298	575	10 / 18
33040G72037M61	3 x 10 + 3 G 1,5	18	491	650	8 / 16
33040G72037M62	3 x 16 + 3 G 2,5	20	723	846	6 / 14
33040G72037M63	3 x 25 + 3 G 4	24	1204	1325	4 / 12
33040G72037M64	3 x 35 + 3 G 6	26	1535	1840	2 / 10
33040G72037M65	3 x 50 + 3 G 10	30	2156	2718	1 / 8
33040G72037M66	3 x 70 + 3 G 10	34	2980	3470	2/0 / 8
33040G72037M67	3 x 95 + 3 G 16	37	3953	4540	3/0 / 6
33040G72037M68	3 x 120 + 3 G 16	42	4836	5865	4/0 / 6
33040G72037M69	3 x 150 + 3 G 25	46	5412	6490	250 MCM / 4
33040G72037M70	3 x 185 + 3 G 35	51	7329	8595	350 MCM / 2
33040G72037M71	3 x 240 + 3 G 42,5	59	10230	11720	450 MCM / 1
33040G72037M72	3 x 300 + 3 G 50	65	11050	13380	550 MCM / 1

Other dimension and colours available on request.

GAALFLEX® VFD 2XSLCHK-J

Inverter, connection to frequency converters, UV Resistant, halogen-free, 0,6/1 kV



ELETTROTEK KABEL® GAALFLEX® VFD 2XSLCHK-J



ELETTROTEK KABEL® GAALFLEX® VFD 2XSLCHK-J



Construction:

Conductor:	flexible red copper conductor Cl. 5, acc to IEC 60228, DIN VDE 0295
Insulation:	special XLPE compound
Cores color:	acc. to DIN VDE 0293-308, HD 308 S2 3 conductors + 3 earth conductors: grey, brown, black and green/yellow divided in interstices 4 cores: green/yellow, brown, black, grey
Stranding:	in layers
Screen:	aluminium tape + PETP foil and tinned copper braid
Outer Sheath:	black (similar RAL 9005), special halogen-free compound

Resistance:



Self-extinguishing and flame retardant acc. to:
DIN VDE 0482 part 265-2-1,
EN 50265-2-1,
IEC 60332-1-2,
DIN VDE 0482 part 266-4-2,
EN 50266-4-2,
IEC 60332-3-24



Halogen-free acc. to:
DIN VDE 0482, part 267
EN 50267-2-1,
IEC 60754-1



Corrosiveness of conflagration gases acc. to:
DIN VDE 0482 part 267
EN 50267-2-2
IEC 60754-2



Low smoke density acc. to:
DIN VDE 0482 part. 268-1-2
IEC 61034-1-2

Technical data:

Nominal voltage:	U ₀ /U 0,6/1 kV
Test voltage:	4 kV
Max. operating voltage:	A.C. and 3 phase 0,7/1,2 kV D.C. operation 0,9/1,8 kV
Peak value \hat{U}:	1,7 kV
Temperature range	
<i>Fixed laying:</i>	- 40 °C up to + 90 °C
<i>Flexible installation:</i>	- 15 °C up to + 90 °C
Max. temperature on conductor:	+ 90°C
Max. temperature in short circuit:	+ 250 °C
Min. bending radius	
<i>Fixed laying:</i>	up to 12 mm: 5 x d > 12 to 20 mm: 7,5 x d > 20 mm: 10 x d
<i>Flexible application:</i>	up to 12 mm: 10 x d > 12 to 20 mm: 15 x d > 20 mm: 20 x d
Insulation resistance:	min. 200 MOhm x km
Radiation resistance:	up to 80x10 ⁶ cJ/kg
Coupling resistance:	depending on the cross-section: max. 250 Ohm/km
Mutual capacitance (4 conductors version):	depending on the cross-section core/core 70 to 250 nF/km core/screen 110 to 410 nF/km

Features:

Suitable for Mining applications!

- UV resistant
- outdoor use
- acc. to DIN VDE 0250
- EMC (electromagnetic compatibility)
- acc. to EN 55011 and DIN VDE 0875 part 11
- low mutual capacitance
- low coupling resistance
- installation in hazardous areas
- low coupling resistance for high electromagnetic compatibility
- RoHS and CE approval



Applications:

suitable in plants and buildings, as a supply and connecting cable for medium mechanical stresses in fixed installations and forced movements in dry, moist and wet environments for outdoor applications. Used in the automobile industry, food industry, environmental engineering, packaging industry, toolmaking machinery, handling equipment, for SIMOVERT drivers, they are particularly suitable for use with industrial pumps, ventilators, conveyor belts and air-conditioning installations and similar applications.

GAALFLEX® VFD CABLES

GAALFLEX® VFD 2XSLCHK-J

Inverter, connection to frequency converters, UV Resistant, halogen-free, 0,6/1 kV



Part no.	No. of cores x cross section n x mm ²	Outer-Ø ca. mm ± 10%	Copper weight kg/km	Cable weight approx. kg/km	AWG no. *)
33050G72041M15	4 G 1,5	11,3	95	230	16
33050G72071M15	7 G 1,5	12,9	151	310	16
33050G72041M25	4 G 2,5	12,4	150	300	14
33050G72071M25	7 G 2,5	14	265	450	14
33050G72041M40	4 G 4	13,6	235	485	12
33050G72041M60	4 G 6	14,8	320	630	10
33050G72041M61	4 G 10	19,3	533	794	8
33050G72041M62	4 G 16	22,6	789	1138	6
33050G72041M63	4 G 25	26,9	1236	1843	4
33050G72041M64	4 G 35	30,2	1662	2610	2
33050G72041M65	4 G 50	35,5	2345	2933	1
33050G72041M66	4 G 70	40,1	3196	3940	2/0
33050G72041M67	4 G 95	44,8	4316	5270	3/0
33050G72041M68	4 G 120	49,6	5435	6558	4/0
33050G72041M69	4 G 150	55,5	6394	7078	250 MCM
33050G72041M70	4 G 185	62,6	7639	8408	350 MCM
33050G72041M71	4 G 240	66,6	10017	11113	450 MCM
33050G72041M72	4 G 300	71,5	12570	13800	550 MCM
33050G72037M15	3 x 1,5 + 3 G 0,25	10,8	89	186	16 / 24
33050G72037M25	3 x 2,5 + 3 G 0,5	11,8	148	252	14 / 20
33050G72037M40	3 x 4 + 3 G 0,75	12,9	224	384	12 / 19
33050G72037M60	3 x 6 + 3 G 1	14,6	298	501	10 / 18
33050G72037M61	3 x 10 + 3 G 1,5	16,6	491	630	8 / 16
33050G72037M62	3 x 16 + 3 G 2,5	19,3	723	845	6 / 14
33050G72037M63	3 x 25 + 3 G 4	22,9	1137	1322	4 / 12
33050G72037M64	3 x 35 + 3 G 6	25,1	1535	1782	2 / 10
33050G72037M65	3 x 50 + 3 G 10	30,1	2182	2559	1 / 8
33050G72037M66	3 x 70 + 3 G 10	34,5	2871	3325	2/0 / 8
33050G72037M67	3 x 95 + 3 G 16	38,9	3953	4566	3/0 / 6
33050G72037M68	3 x 120 + 3 G 16	42,1	4836	5609	4/0 / 6
33050G72037M69	3 x 150 + 3 G 25	47,5	5412	6301	250 MCM / 4
33050G72037M70	3 x 185 + 3 G 35	52,3	7023	7892	350 MCM / 2
33050G72037M71	3 x 240 + 3 G 42,5	58,2	9130	10358	450 MCM / 1
33050G72037M72	3 x 300 + 3 G 50	69,5	11050	11560	550 MCM / 1

Other dimension and colours available on request.

GAALFLEX® VFD 1100 PH

Inverter, connection to frequency converters, UV Resistant, halogen-free, 0,6/1 kV



Construction:

Conductor:	flexible red copper conductor Cl. 5, acc to IEC 60228, DIN VDE 0295
Insulation:	GAALTHERM® 630
Cores color:	acc. to DIN VDE 0293-308, HD 308 S2 3 conductors + 3 earth conductors: grey, brown, black and green/yellow divided in interstices 4 cores: green/yellow, brown, black, grey
Stranding:	in layers
Screen:	aluminium tape + PETP foil and tinned copper braid
Outer Sheath:	black (similar RAL 9005) special PUR compound

Technical data:

Nominal voltage:	U ₀ /U 0,6/1 kV
Test voltage:	4 kV
Max. operating voltage:	A.C. and 3 phase 0,7/1,2 kV D.C. operation 0,9/1,8 kV
Peak value \hat{U}:	1,7 kV
Temperature range	
<i>Fixed laying:</i>	- 50 °C up to + 90 °C
<i>Flexible installation:</i>	- 40 °C up to + 90 °C
Max. temperature on conductor:	+ 90°C
Max. temperature in short circuit:	+ 250 °C
Min. bending radius	
<i>Fixed laying:</i>	up to 12 mm: 5 x d > 12 to 20 mm: 7,5 x d > 20 mm: 10 x d
<i>Flexible applicaton:</i>	up to 12 mm: 10 x d > 12 to 20 mm: 15 x d > 20 mm: 20 x d
Insulation resistance:	min. 200 MOhm x km
Radiation resistance:	up to 80x10 ⁶ cJ/kg
Coupling resistance:	depending on the cross-section: max. 250 Ohm/km
Mutual capacitance (4 conductors version):	depending on the cross-section core/core 70 to 250 nF/km core/screen 110 to 410 nF/km

Resistance:



Self-extinguishing and flame retardant acc. to:
DIN VDE 0482 part 265-2-1,
EN 50265-2-1,
IEC 60332-1-2



Halogen-free acc. to:
DIN VDE 0482, part 267
EN 50267-2-1,
IEC 60754-1

Features:

NEW VERSION! FOR HEAVY APPLICATIONS

- UV resistant
- outdoor use
- acc. to DIN VDE 0250
- EMC (electromagnetic compatibility)
- acc. to EN 55011 and DIN VDE 0875 part 11
- low mutual capacitance
- low coupling resistance
- installation in hazardous areas
- low coupling resistance for high electromagnetic compatibility
- RoHS and CE approval

On request:

acc. to DIN VDE 0482 part 265-5-2 / EN 50266-5-2 / IEC 60332-3-24
identified with "5" on the 5th number of the Part. no



Applications:

suitable in plants and buildings, as a supply and connecting cable for medium mechanical stresses in fixed installations and forced movements in dry, moist and wet environments for outdoor applications. Used in the automobile industry, food industry, environmental engineering, packaging industry, toolmaking machinery, handling equipment, for SIMOVERT drivers, they are particularly suitable for use with industrial pumps, ventilators, conveyor belts and air-conditioning installations and similar applications.

GAALFLEX® VFD CABLES

GAALFLEX® VFD 1100 PH

Inverter, connection to frequency converters, UV Resistant, halogen-free, 0,6/1 kV



Part no.	No. of cores x cross section n x mm ²	Outer-Ø ca. mm ± 10%	Copper weight kg/km	Cable weight approx. kg/km	AWG no. *)
33060G72041M15	4 G 1,5	10,6	95	230	16
33060G72041M25	4 G 2,5	12,3	150	300	14
33060G72041M40	4 G 4	14,5	235	485	12
33060G72041M60	4 G 6	16,4	320	633	10
33060G72041M61	4 G 10	20,1	533	863	8
33060G72041M62	4 G 16	23,4	789	1291	6
33060G72041M63	4 G 25	27	1236	1862	4
33060G72041M64	4 G 35	30,7	1662	2611	2
33060G72041M65	4 G 50	36,1	2345	2955	1
33060G72041M66	4 G 70	42,3	3196	3953	2/0
33060G72041M67	4 G 95	47,7	4316	5304	3/0
33060G72041M68	4 G 120	51,9	5435	6604	4/0
33060G72041M69	4 G 150	57,5	6394	7043	250 MCM
33060G72041M70	4 G 185	61,1	7639	8384	350 MCM
33060G72041M71	4 G 240	67	10013	11010	450 MCM
33060G72041M72	4 G 300	71,5	12570	13800	550 MCM
33060G72037M15	3 x 1,5 + 3 G 0,25	10,2	86	140	16 / 24
33060G72037M25	3 x 2,5 + 3 G 0,5	11,4	144	220	14 / 20
33060G72037M40	3x4 +3 G 0,75	13	224	323	12 / 19
33060G72037M60	3 x 6 +3 G 1	15	298	420	10 / 18
33060G72037M61	3 x 10 + 3 G 1,5	18,4	491	615	8 / 16
33060G72037M62	3 x 16 + 3 G 2,5	21,6	723	819	6 / 14
33060G72037M63	3 x 25 + 3 G 4	25,3	1138	1325	4 / 12
33060G72037M64	3 x 35 + 3 G 6	27,8	1535	1718	2 / 10
33060G72037M65	3 x 50 + 3 G 10	32,6	2208	2399	1 / 8
33060G72037M66	3 x 70 + 3 G 10	39	2871	3056	2/0 / 8
33060G72037M67	3 x 95 +3 G 16	44,3	3953	4162	3/0 / 6
33060G72037M68	3 x 120 +3 G 16	46,3	4836	5074	4/0 / 6
33060G72037M69	3 x 150 + 3 G 25	53,5	5412	6128	250 MCM / 4
33060G72037M70	3 x 185 + 3 G 35	59,5	6969	7189	350 MCM / 2
33060G72037M71	3 x 240 +3 G 42,5	65,2	8540	9540	450 MCM / 1
33060G72037M72	3 x 300 + 3 G 50	69,5	11050	11560	550 MCM / 1

Other dimension and colours available on request.

GAALFLEX® TRAY VFD I 500 T

Inverter, connection to frequency converters, UV Resistant, UL 2277 WTTC 1000 V 90°C Dry 75°C Wet



Construction:

Conductor:	finely stranded red copper, acc.to ASTM B-3 or ASTM B-33 and B-172 or B-174
Insulation:	special PVC/Nylon compound
Cores color:	4 conductors: black conductors and green/yellow or 3 black conductors + 3 earth conductors
Stranding:	in layers
Screen:	aluminium tape + PETP foil and tinned copper braid + tinned copper drain wire
Ripcord:	high strenght ripcord under outer sheath
Outer Sheath:	black (similar RAL 9005), special TPE compound

Technical data:

Nominal voltage UL:	1000 V
Temperature range	
<i>Fixed laying:</i>	- 25 °C up to + 90 °C
<i>Flexible installation:</i>	- 25 °C up to + 90 °C
Min. bending radius	6 x D

Resistance:



Fire performance acc. to:
c(UL) FT4

Features:

- UV resistant
- outdoor use
- installation in hazardous areas
- UL Type TC-ER c(UL) Type CIC FT4, Sun Res, Oil Res I
- UL 1277 60°C 600 V WTTC and UL 1277, UL type TC-ER for 600 V on request
- UL 2277 WTTC 1000 V 90°C dry
- RoHS approval
- tinned copper on request
- on request MSHA approved



UL/CSA Standards:

- ASTM B-3
- ASTM B-33
- ASTM B-172
- ASTM B-174
- UL 66 basic construction, test and marking
- UL 83 600 V thermoplastic insulation
- UL 1277 60°C for Oil Res I
- CSA C22.2 No 230 for tray cable
- CSA C22.2 No 239 for control and instrumentation cable

GAALFLEX® VFD CABLES

GAALFLEX® TRAY VFD I 500 T

Inverter, connection to frequency converters, UV Resistant, UL 2277 WTTTC 1000V 90°C Dry 75°C Wet



Part no.	No. of cores x cross section n x AWG/MCM	Outer Ø inches/mm ±10%	Cable weight approx. Lbs/Mft - kg/km
33070H70041A16	4 G 16	0,395 - 10	121 - 180
33070H70041A14	4 G 14	0,435 - 11	153 - 228
33070H70041A12	4 G 12	0,475 - 12,1	197 - 293
33070H70041A10	4 G 10	0,595 - 15,1	296 - 441
33070H70041A08	4 G 8	0,73 - 18,5	440 - 654
33070H70041A06	4 G 6	0,825 - 21	609 - 907
33070H70041A04	4 G 4	1,045 - 26,5	940 - 1399
33070H70041A02	4 G 2	1,19 - 30,2	1328 - 1976
33070H70041A01	4 G 1	1,33 - 33,8	1651 - 2457
33070H70041A1C	4 G 1/0	1,425 - 36,2	1986 - 2955
33070H70041A2C	4 G 2/0	1,545 - 39,2	2405 - 3579
33070H70041A3C	4 G 3/0	1,665 - 42,3	2917 - 4340
33070H70041A4C	4 G 4/0	1,915 - 48,6	3721 - 5536
33070H70041A5C	4 G 250 MCM	2,09 - 53,1	4336 - 6452
33070H70041A6C	4 G 300 MCM	2,195 - 55,8	5036 - 7494
33070H70041A7C	4 G 350 MCM	2,33 - 59,2	5809 - 8644
33070H70041A8C	4 G 400 MCM	2,4 - 61	6442 - 9586
33070H70041AAC	4 G 500 MCM	2,615 - 66,4	7886 - 11705
33070H70037A08	3x8+3G14	0,7 - 17,8	401 - 597
33070H70037A02	3x6+3G12	0,785 - 19,9	554 - 824
33070H70037A04	3x4+3G12	0,975 - 24,8	809 - 1204
33070H70037A02	3x2+3G10	1,105 - 28,1	1147 - 1707
33070H70037A01	3x1+3G8	1,235 - 31,4	1471 - 2189
33070H70037A1C	3x1/0+3G8	1,315 - 33,4	1719 - 2558
33070H70037A2C	3x2/0+3G8	1,42 - 36,1	2032 - 3024
33070H70037A3C	3x3/0+3G6	1,53 - 38,9	2521 - 3751
33070H70037A4C	3x4/0+3G6	1,76 - 44,7	3139 - 4671
33070H70037A5C	3x250 MCM+3G6	1,915 - 48,6	3596 - 5351
33070H70037A6C	3x300 MCM+3G4	2,01 - 51,1	4296 - 6392
33070H70037A7C	3x350 MCM+3G4	2,13 - 54,1	4873 - 7521
33070H70037A8C	3x400 MCM+3G4	2,195 - 55,8	5347 - 7956
33070H70037AAC	3x500 MCM+3G2	2,39 - 60,7	6653 - 9900

Other dimension and colours available on request.

GAALFLEX® TRAY VFD 1510 T

Inverter, connection to frequency converters, UV Resistant, UL 2277 WTTC 1000 V 90°C Dry 75°C Wet

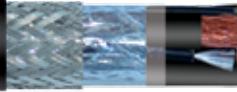
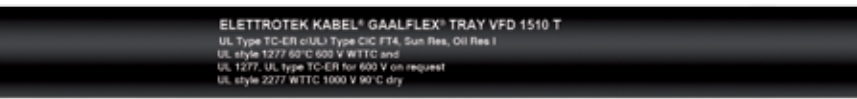

Construction:

- Conductor:** flexible red copper conductor Cl. 5, acc to IEC 60228, DIN VDE 0295
- Insulation:** special PVC/Nylon compound
- Cores color:** 4 conductors: black conductors and green/yellow or 3 black conductors + 3 earth conductors
- Stranding:** in layers
- Screen:** aluminium tape + PETP foil and tinned copper braid + tinned copper drain wire
- Ripcord:** high strength ripcord under outer sheath
- Outer Sheath:** black (similar RAL 9005), special TPE compound

Technical data:

- Nominal voltage UL:** 1000 V
- Temperature range**
- Fixed laying:* - 25 °C up to + 90 °C
- Flexible installation:* - 25 °C up to + 90 °C
- Min. bending radius** 6 x D

Resistance:



Fire performance acc. to:
c(UL) FT4

Features:

- UV resistant
- outdoor use
- installation in hazardous areas
- UL Type TC-ER c(UL) Type CIC FT4, Sun Res, Oil Res I
- UL 1277 60°C 600 V WTTC and UL 1277, UL type TC-ER for 600 V on request
- UL 2277 WTTC 1000 V 90°C dry
- RoHS approval
- tinned copper on request
- on request MSHA approved



UL/CSA Standards:

- ASTM B-3
- ASTM B-33
- ASTM B-172
- ASTM B-174
- UL 66 basic construction, test and marking
- UL 83 600 V thermoplastic insulation
- UL 1277 60°C for Oil Res I
- CSA C22.2 No 230 for tray cable
- CSA C22.2 No 239 for control and instrumentation cable

GAALFLEX® VFD CABLES

GAALFLEX® TRAY VFD 1510 T

Inverter, connection to frequency converters, UV Resistant, UL 2277 WTTC 1000 V 90°C Dry 75°C Wet



ELETTROTEK KABEL® GAALFLEX® TRAY VFD 1510 T

UL Type TC-ER or UL Type CIC FT4, Sun Res., Oil Res. I
UL style 1277 60°C 600 V WTTC and
UL 1277, UL Type TC-ER for 600 V on request
UL style 2277 WTTC 1000 V 90°C dry



ELETTROTEK KABEL® GAALFLEX® TRAY VFD 1510 T

UL Type TC-ER or UL Type CIC FT4, Sun Res., Oil Res. I
UL style 1277 60°C 600 V WTTC and
UL 1277, UL Type TC-ER for 600 V on request
UL style 2277 WTTC 1000 V 90°C dry



Part no.	No. of cores x cross section n x mm ²	Outer Ø inches/mm ±10%	Cable weight approx. Lbs/Mft - kg/km	AWG no.)*
33080H70041A16	4 G 1,5	0,395 - 10	121 - 180	16
33080H70041A14	4 G 2,5	0,435 - 11	153 - 228	14
33080H70041A12	4 G 4	0,475 - 12,1	197 - 293	12
33080H70041A10	4 G 6	0,595 - 15,1	296 - 441	10
33080H70041A08	4 G 10	0,73 - 18,5	440 - 654	8
33080H70041A06	4 G 16	0,825 - 21	609 - 907	6
33080H70041A04	4 G 25	1,045 - 26,5	940 - 1399	4
33080H70041A02	4 G 35	1,19 - 30,2	1328 - 1976	2
33080H70041A01	4 G 50	1,33- 33,8	1651 - 2457	1
33080H70041A2C	4 G 70	1,545 - 39,2	2405 - 3579	2/0
33080H70041A3C	4 G 95	1,665 - 42,3	2917 - 4340	3/0
33080H70041A4C	4 G 120	1,915 - 48,6	3721 - 5536	4/0
33080H70041A5C	4 G 150	2,09 - 53,1	4336 - 6452	250 MCM
33080H70041A7C	4 G 185	2,33 - 59,2	5809 - 8644	350 MCM
33080H70041A9C	4 G240	2,5 - 63,7	7437 - 11100	450 MCM
33080H70037A08	3x10+3G2,5	0,7 - 17,8	401 - 597	8 / 14
33080H70037A06	3x16+3G4	0,785 - 19,9	554 - 824	6 / 12
33080H70037A04	3x25+3G4	0,975 - 24,8	809 - 1204	4 / 12
33080H70037A02	3x35+3G6	1,105 - 28,1	1147 - 1707	2 / 10
33080H70037A01	3x50+3G10	1,235 - 31,4	1471 - 2189	1 / 8
33080H70037A2C	3x70+3G10	1,42 - 36,1	2032 - 3024	2/0 / 8
33080H70037A3C	3x95+3G16	1,53 - 38,9	2521 - 3751	3/0 / 6
33080H70037A4C	3x120+3G16	1,76 - 44,7	3139 - 4671	4/0 / 6
33080H70037A5C	3x150+3G16	1,915 - 48,6	3596 - 5351	250 MCM / 6
33080H70037A7C	3x185+3G25	2,13 - 54,1	4873 - 7521	350 MCM / 6
33080H70037A9C	3x240+3G35	2,26 - 57,3	6378 - 9520	450 MCM / 2

Other dimension and colours available on request.

GAALFLEX® VFD CABLES

GAALFLEX® TRAY VFD I 520

Inverter, connection to frequency converters, UV Resistant, UL 2277 WTTC 1000 V 90°C Dry 75°C Wet



Construction:

- Conductor:** flexible tinned copper conductor Cl. 5, acc. to IEC 60228, DIN VDE 0295
- Insulation:** GAALTHERM® 530
- Cores color:** 4 conductors: black conductors and green/yellow or 3 black conductors + 3 earth conductors
- Stranding:** in layers
- Screen:** aluminium tape + PETP foil and tinned copper braid + tinned copper drain wire
- Ripcord:** high strength ripcord under outer sheath
- Outer Sheath:** black (similar RAL 9005), special CPE compound

Technical data:

- Nominal voltage UL:** 1000 V
- Temperature range**
- Fixed laying:* - 25 °C up to + 90 °C
- Flexible installation:* - 25 °C up to + 90 °C
- Min. bending radius** 6 x D

Resistance:



Fire performance acc. to:
c(UL) FT4

Features:

- MSHA APPROVED
- UV resistant
- outdoor use
- installation in hazardous areas
- UL TC-ER c(UL) Type CIC FT4, Sun Res, Oil Res I
- UL 1277 60°C 600 V WTTC and UL 1277, UL type TC-ER for 600 V on request
- UL 2277 WTTC 1000 V 90°C dry
- RoHS approval



UL/CSA Standards:

- ASTM B-3
- ASTM B-33
- ASTM B-172
- ASTM B-174
- UL 66 basic construction, test and marking
- UL 83 600 V thermoplastic insulation
- UL 1277 60°C for Oil Res I
- CSA C22.2 No 230 for tray cable
- CSA C22.2 No 239 for control and instrumentation cable

GAALFLEX® VFD CABLES

GAALFLEX® TRAY VFD I 520

Inverter, connection to frequency converters, UV Resistant, UL 2277 WTTC 1000V 90°C Dry 75°C Wet



ELETTROTEK KABEL® GAALFLEX® TRAY VFD 1520
 UL Type TC-ER c(UL) Type CJC FT4, Sun Res, Oil Res I
 UL style 1277 90°C 600 V WTTC and
 UL 1277, UL type TC-ER for 600 V on request
 UL style 2277 WTTC 1000 V 90°C dry



ELETTROTEK KABEL® GAALFLEX® TRAY VFD 1520
 UL Type TC-ER c(UL) Type CJC FT4, Sun Res, Oil Res I
 UL style 1277 90°C 600 V WTTC and
 UL 1277, UL type TC-ER for 600 V on request
 UL style 2277 WTTC 1000 V 90°C dry



Part no.	No. of cores x cross section n x mm ²	Outer Ø inches/mm ±10%	Cable weight approx. Lbs/Mft - kg/km	AWG no.)*
33090H70041A16	4 G 1,5	0,395 - 10	121 - 180	16
33090H70041A14	4 G 2,5	0,435 - 11	153 - 228	14
33090H70041A12	4 G 4	0,475 - 12,1	197 - 293	12
33090H70041A10	4 G 6	0,595 - 15,1	296 - 441	10
33090H70041A08	4 G 10	0,73 - 18,5	440 - 654	8
33090H70041A06	4 G 16	0,825 - 21	609 - 907	6
33090H70041A04	4 G 25	1,045 - 26,5	940 - 1399	4
33090H70041A02	4 G 35	1,19 - 30,2	1328 - 1976	2
33090H70041A01	4 G 50	1,33- 33,8	1651 - 2457	1
33090H70041A2C	4 G 70	1,545 - 39,2	2405 - 3579	2/0
33090H70041A3C	4 G 95	1,665 - 42,3	2917 - 4340	3/0
33090H70041A4C	4 G 120	1,915 - 48,6	3721 - 5536	4/0
33090H70041A5C	4 G 150	2,09 - 53,1	4336 - 6452	250 MCM
33090H70041A7C	4 G 185	2,33 - 59,2	5809 - 8644	350 MCM
33090H70041A9C	4 G240	2,5 - 63,7	7437 - 11100	450 MCM
33090H70037A08	3x10+3G2,5	0,7 - 17,8	401 - 597	8 / 14
33090H70037A06	3x16+3G4	0,785 - 19,9	554 - 824	6 / 12
33090H70037A04	3x25+3G4	0,975 - 24,8	809 - 1204	4 / 12
33090H70037A02	3x35+3G6	1,105 - 28,1	1147 - 1707	2 / 10
33090H70037A01	3x50+3G10	1,235 - 31,4	1471 - 2189	1 / 8
33090H70037A2C	3x70+3G10	1,42 - 36,1	2032 - 3024	2/0 / 8
33090H70037A3C	3x95+3G16	1,53 - 38,9	2521 - 3751	3/0 / 6
33090H70037A4C	3x120+3G16	1,76 - 44,7	3139 - 4671	4/0 / 6
33090H70037A5C	3x150+3G16	1,915 - 48,6	3596 - 5351	250 MCM / 6
33090H70037A7C	3x185+3G25	2,13 - 54,1	4873 - 7521	350 MCM / 6
33090H70037A9C	3x240+3G35	2,26 - 57,3	6378 - 9520	450 MCM / 2

Other dimension and colours available on request.

GAALFLEX® VFD CABLES

GAALFLEX® TRAY VFD I 400

Inverter, connection to frequency converters, UV Resistant, UL 2277 WTTC 1000 V 90°C Dry 75°C Wet



Construction:

- Conductor:** flexible red copper conductor Cl. 5, acc. to IEC 60228, DIN VDE 0295
- Insulation:** special PVC/Nylon compound
- Cores color:** 4 conductors: black conductors and green/yellow or 3 black conductors + 3 earth conductors
- Stranding:** in layers
- Screen:** aluminium tape + PETP foil and tinned copper braid + tinned copper drain wire
- Ripcord:** high strength ripcord under outer sheath
- Outer Sheath:** black (similar RAL 9005), special PVC compound

Technical data:

- Nominal voltage UL:** 1000 V
- Temperature range**
- Fixed laying:* - 25 °C up to + 90 °C
- Flexible installation:* - 25 °C up to + 90 °C
- Min. bending radius** 6 x D

Resistance:



Fire performance acc. to:
c(UL) FT4

Features:

- UV resistant
- outdoor use
- installation in hazardous areas
- UL Type TC-ER c(UL) Type CIC FT4, Sun Res, Oil Res I
- UL 1277 60°C 600 V WTTC and
- UL 1277, UL type TC-ER for 600 V on request
- UL 2277 WTTC 1000 V 90°C dry
- RoHS approval
- tinned copper on request
- on request MSHA approved



UL/CSA Standards:

- ASTM B-3
- ASTM B-33
- ASTM B-172
- ASTM B-174
- UL 66 basic construction, test and marking
- UL 83 600 V thermoplastic insulation
- UL 1277 60°C for Oil Res I
- CSA C22.2 No 230 for tray cable
- CSA C22.2 No 239 for control and instrumentation cable

GAALFLEX® VFD CABLES

GAALFLEX® TRAY VFD I 400

Inverter, connection to frequency converters, UV Resistant, UL 2277 WTTTC 1000V 90°C Dry 75°C Wet



ELETTROTEK KABEL® GAALFLEX® TRAY VFD I 400
UL Type TC-ER (solid) Type DIC FTA, Sun Res, Oil Res I
UL style 2277 90°C 600 V WTTTC and
UL 2277, UL Type TC-ER for 600 V on request
UL style 2277 WTTTC 1000 V 90°C dry



ELETTROTEK KABEL® GAALFLEX® TRAY VFD I 400
UL Type TC-ER (solid) Type DIC FTA, Sun Res, Oil Res I
UL style 2277 90°C 600 V WTTTC and
UL 2277, UL Type TC-ER for 600 V on request
UL style 2277 WTTTC 1000 V 90°C dry



Part no.	No. of cores x cross section n x mm ²	Outer Ø inches/mm ±10%	Cable weight approx. Lbs/Mft - kg/km	AWG no.)*
33100H70041A16	4 G 1,5	0,395 - 10	121 - 180	16
33100H70041A14	4 G 2,5	0,435 - 11	153 - 228	14
33100H70041A12	4 G 4	0,475 - 12,1	197 - 293	12
33100H70041A10	4 G 6	0,595 - 15,1	296 - 441	10
33100H70041A08	4 G 10	0,73 - 18,5	440 - 654	8
33100H70041A06	4 G 16	0,825 - 21	609 - 907	6
33100H70041A04	4 G 25	1,045 - 26,5	940 - 1399	4
33100H70041A02	4 G 35	1,19 - 30,2	1328 - 1976	2
33100H70041A01	4 G 50	1,33- 33,8	1651 - 2457	1
33100H70041A2C	4 G 70	1,545 - 39,2	2405 - 3579	2/0
33100H70041A3C	4 G 95	1,665 - 42,3	2917 - 4340	3/0
33100H70041A4C	4 G 120	1,915 - 48,6	3721 - 5536	4/0
33100H70041A5C	4 G 150	2,09 - 53,1	4336 - 6452	250 MCM
33100H70041A7C	4 G 185	2,33 - 59,2	5809 - 8644	350 MCM
33100H7004A9C	4 G240	2,5 - 63,7	7437 - 11100	450 MCM
33100H70037A08	3x10+3G2,5	0,7 - 17,8	1651 - 2457	8 / 14
33100H70037A06	3x16+3G4	0,785 - 19,9	2405 - 3579	6 / 12
33100H70037A04	3x25+3G4	0,975 - 24,8	2917 - 4340	4 / 12
33100H70037A02	3x35+3G6	1,105 - 28,1	3721 - 5536	2 / 10
33100H70037A01	3x50+3G10	1,235 - 31,4	4336 - 6452	1 / 8
33100H70037A2C	3x70+3G10	1,42 - 36,1	5809 - 8644	2/0 / 8
33100H70037A3C	3x95+3G16	1,53 - 38,9	7437 - 11100	3/0 / 6
33100H70037A4C	3x120+3G16	1,76 - 44,7	3139 - 4671	4/0 / 6
33100H70037A5C	3x150+3G16	1,915 - 48,6	3596 - 53 51	250 MCM / 6
33100H70037A7C	3x185+3G25	2,13 - 54,1	4873 - 7521	350 MCM / 6
33100H70037A9C	3x240+3G35	2,26 - 57,3	6378 - 9520	450 MCM / 2

Other dimension and colours available on request.

GAALFLEX® TRAY VFD I405

Inverter, connection to frequency converters, UV Resistant, UL 2277 WTTC 1000 V 90°C Dry or 90°C Wet or UL 2277 Flexible Motor Supply Cable 2000 V 90°C Dry up to 4/0 AWG or UL 1277 TC-ER 2000 V 90°C Dry or 90°C Wet



ELETTROTEK KABEL® GAALFLEX® TRAY VFD I405
 UL style 2277 WTTC 1000 V 90°C Dry or 90°C Wet or UL 2277 Flexible Motor Supply Cable 2000 V 90°C Dry up to 4/0 AWG or UL Listed Type TC-ER, 90°C DRY or WET, 2000 V, SUN RES, DIR BUR, FT4 acc. to UL 1277, c(UL) Listed Type CIC, FT4 acc. to CSA C22.2 No. 239



Construction:

- Conductor:** finely stranded red copper, acc.to ASTM B-3 and B-172 6 AWG and smaller acc.to ASTM B-3 and B-174
- Insulation:** GAALTHERM® 590
- Cores color:** 3 black conductors + 3 earth conductors
- Stranding:** in layers
- Screen:** aluminium tape + PETP foil and tinned copper braid + tinned copper drain wire
- Ripcord:** high strenght ripcord under outer sheath
- Outer Sheath:** black (similar RAL 9005), special PVC compound

Resistance:



Fire performance acc. to: IEEE 1202, c(UL) FT4

Features:

- UV resistant
- outdoor use
- oil resistant
- installation in hazardous areas
- DIRECT BURIAL
- UL Listed Type TC-ER, 90°C DRY or WET, 2000V, SUN RES, DIR BUR, FT4 acc. to UL 1277, c(UL) Listed Type CIC, FT4 acc. to CSA C22.2 No. 239
- UL 2277 WTTC 1000 V 90°C Dry or 90°C Wet
- UL 2277 Flexible Motor Supply Cable 2000 V 90°C Dry up to 4/0 AWG
- on request MSHA approved
- on request tinned copper acc. to ASTM B-33
- RoHS approval



Technical data:

- Nominal voltage UL:** 2000 V
- Max. permissible Peak. voltage:** 2828 V A.C.
- Test voltage (acc. to UL 1277):**
- 14 AWG up to 8 AWG: 6000 V
 - 6 AWG up to 2 AWG: 7500 V
 - 1 AWG up to 4/0 AWG: 9000 V
 - 250 MCM up to 500 MCM: 10000 V
- Temperature range**
- Fixed laying: - 25 °C up to + 90 °C
 - Flexible installation: - 25 °C up to + 90 °C
- Min. bending radius** 6 x d

UL Standards:

- UL 44 2000 V thermoset insulation
- UL 2277 WTTC 1000 V 90°C Dry or 90°C Wet
- UL 2277 Flexible Motor Supply Cable 2000 V 90°C Dry up to 4/0 AWG
- UL 1277 Type TC-ER 2000 V 90°C Dry or 90°C Wet

Part no.	No. of cores x cross section n x AWG/MCM	Outer Ø inches/mm ±10%	Cable weight approx. Lbs/Mft - kg/km
33290170037A14	3 x 14 + 3 x 18	0,80 - 20	375 - 558
33290170037A12	3 x 12 + 3 x 16	0,82 - 20,8	410 - 610
33290170037A10	3 x 10 + 3 x 14	0,90 - 22,9	505 - 752
33290170037A08	3 x 8 + 3 x 14	0,97 - 24,63	615 - 915
33290170037A06	3 x 6 + 3 x 12	1,005 - 25,5	716 - 1065
33290170037A04	3 x 4 + 3 x 12	1,115 - 28,3	923 - 1373
33290170037A02	3 x 2 + 3 x 10	1,25 - 31,8	1273 - 1894
33290170037A01	3 x 1 + 3 x 10	1,42 - 36,1	1579 - 2350
33290170037A1C	3 x 1/0 + 3 x 10	1,515 - 38,5	1847 - 2748
33290170037A2C	3 x 2/0 + 3 x 10	1,62 - 41,1	2183 - 3248
33290170037A3C	3 x 3/0 + 3 x 8	1,735 - 44,1	2662 - 3961
33290170037A4C	3 x 4/0 + 3 x 8	1,975 - 50,2	3283 - 4885
33290170037A5C	3 x 250 + 3 x 6	2,16 - 54,9	3952 - 5881
33290170037A6C	3 x 300 + 3 x 6	2,255 - 57,3	4507 - 6706
33290170037A7C	3 x 350 + 3 x 6	2,38 - 60,5	5119 - 7617
33290170037A8C	3 x 400 + 3 x 6	2,45 - 62,2	5612 - 8351
33290170037AAC	3 x 500 + 3 x 6	2,645 - 67,2	6733 - 10019

Other dimension and colours available on request.

GAALFLEX® TRAY VFD 1410

Inverter, connection to frequency converters, UV Resistant, UL 1277 type TC-ER 2000 V 90°C Dry 90°C Wet



ELETTROTEK KABEL* GAALFLEX® TRAY VFD 1410
 UL 1277 Type TC-ER, 2000 V
 UL: Type RHH or RHW-2 conductors per UL 44
 and ICEA S-95-658, NEMA WC 70
 CSA: c (UL) CIC/TC FT4



Construction:

- Conductor:** stranded red copper, acc.to ASTM B-3 and ASTM B-8
- Insulation:** special XLPE compound
- Cores color:** acc. to ICEA S-58 679 method 4 black conductors whit number printed
- Earth conductor:** stranded red copper, acc.to ASTM B-3 and ASTM B-8
- Earth conductor insulation:** uninsulated
- Stranding:** in layers
- Screen:** red copper tape
- Outer Sheath:** black (similar RAL 9005), special PVC compound

Resistance:



- Flame test acc. to:**
- UL 1581,
 - UL 2556 VW-1,
 - CSA FT4,
 - UL 1685 vertical flame test,
 - IEEE 383, IEEE 1202 vertical tray flame test,
 - ICEA T-29-520

Technical data:

- Nominal voltage UL:** 2000 V
- Temperature range**
- Fixed laying:* - 25 °C up to + 90 °C
- Flexible application:* - 25 °C up to + 90 °C
- Min. bending radius:** 12 x d

Features:

- UV resistant
- outdoor use
- installation in hazardous areas
- on request special EPR compound insulation version
- on request 4 conductor version
- UL 1277 Type TC-ER, 2000 V
- UL: type RHH or RHW-2 conductors per UL 44 and ICEA S-95-658, NEMA WC 70
- CSA: c (UL) CIC/TC FT4
- RoHS approval
- EPA 40 CFR, part 261
- OSHA and MSHA on request



UL/CSA Standards:

- UL 44 2000 V thermoplastic insulation
- UL 1277 60°C for Oil Res I
- CSA C22.2 No 230 for tray cable
- CSA C22.2 No 239 for control and instrumentation cable

GAALFLEX® VFD CABLES

GAALFLEX® TRAY VFD I410

Inverter, connection to frequency converters, UV Resistant, UL 1277 type TC-ER 2000 V 90°C Dry 90°C Wet



ELETTROTEK KABEL® GAALFLEX® TRAY VFD I410
 UL 1277 Type TC-ER, 2000 V
 UL - type RHH or RHW-2 conductors per UL 44
 and IEEE 5-95-656, NEMA WC 70
 CDA: c. UL® CIGTG F14



Part no.	No. of cores x cross section n x AWG/MCM	Outer Ø inches/mm ±10%	Copper weight		Cable weight approx.	
			Lbs/Mft -	kg/km	Lbs/Mft -	kg/km
33110171037A14	3 x 14 + 3 x 18	0,58 - 14,73	91 - 135		212 - 315	
33110171037A12	3 x 12 + 3 x 16	0,615 - 15,37	127 - 189		260 - 387	
33110171037A10	3 x 10 + 3 x 14	0,67 - 24,8	183 - 272		329 - 490	
33110171037A08	3 x 8 + 3 x 14	0,77 - 28,1	246 - 366		441 - 656	
33110171037A06	3 x 6 + 3 x 12	0,895 - 31,4	368 - 548		618 - 920	
33110171037A04	3 x 4 + 3 x 12	0,995 - 36,1	522 - 777		830 - 1235	
33110171037A02	3 x 2 + 3 x 10	1,125 - 38,9	801 - 1192		1152 - 1714	
33110171037A1C	3 x 1/0 + 3 x 6	1,385 - 35,18	1348 - 2006		1853 - 2757	
33110171037A2C	3 x 2/0 + 3 x 6	1,48 - 37,59	1616 - 2405		2169 - 3227	
33110171037A3C	3 x 3/0 + 3 x 5	1,59 - 40,39	2010 - 2991		2619 - 3897	
33110171037A4C	3 x 4/0 + 3 x 4	1,78 - 45,21	2517 - 3745		3241 - 4823	
33110171037A5C	3 x 250 + 3 x 4	1,94 - 49,28	2895 - 4308		3763 - 5599	
33110171037A7C	3 x 350 + 3 x 2	2,16 - 54,86	4089 - 6084		5109 - 7602	
33110171037AAC	3 x 500 + 3 x 1	2,45 - 62,36	5693 - 8471		6933 - 10316	

Other dimension and colours available on request.

GAALFLEX® TRAY VFD 1420

Inverter, connection to frequency converters, UV Resistant,

UL 1277, WTTC 90°C DRY 1000 V, UL type TC-ER 2000 V 90°C Dry 90°C wet, cUL type CIC/TC FT4



ELETTROTEK KABEL® SPECIAL GAALFLEX® TRAY VFD 1420
 UL 1277 Type TC-ER 2000 V, 90°C Dry 90°C Wet, 1000 V, 90°C Dry 90°C Wet, 1000 V, 90°C Dry 90°C Wet
 UL type RHH-2 conductors per UL 44
 CSA c (UL) CIC/TC FT4



Construction:

- Conductor:** finely stranded red copper, acc.to ASTM B-3 and ASTM B-174
- Insulation:** special XLPE compound
- Cores color:** acc. to ICEA S-58 679 method 4 black conductors whit number printed
- Earth conductor:** finely stranded red copper acc.to ASTM B-3 or ASTM B-174
- Earth conductor insulation:** uninsulated
- Stranding:** in layers
- Screen:** red copper tape
- Outer Sheath:** black (similar RAL 9005), special PVC compound

Technical data:

- Nominal voltage UL:** 2000 V
- Temperature range**
- Fixed laying:* - 25 °C up to + 90 °C
- Flexible installation:* - 25 °C up to + 90 °C
- Min. bending radius** 12 x d

Resistance:



Flame test acc. to:
 UL 1581 / UL 2556 VW-1, CSA FT4,
 UL 1685 vertical flame test,
 IEEE 383, IEEE 1202 vertical tray flame test,
 ICEA T-29-520

Features:

- UV resistant
- outdoor use
- installation in hazardous areas
- UL 1277 type TC-ER 2000 V, 90°C Dry 90°C Wet
- WTTC 90°C DRY 1000 V
- UL: type RHH or RHW-2 conductors per UL 44 and ICEA S-95-658, NEMA WC 70
- on request UL type TC-ER 600 V 90°C Dry 90°C Wet
- CSA: c (UL) CIC/TC FT4
- RoHS approval
- EPA 40 CFR, part 261
- OSHA and MSHA on request
- on request special EPR compound insulation version
- tinned copper on request



UL/CSA Standards:

- UL 44 2000 V thermoplastic insulation
- UL 1277 60°C for Oil Res I
- CSA C22.2 No 230 for tray cable
- CSA C22.2 No 239 for control and instrumentation cable

Part no.	No. of cores x cross section n x AWG/MCM	Outer Ø inches/mm ±10%	Copper weight Lbs/Mft - kg/km	Cable weight approx. Lbs/Mft - kg/km
33120171037A14	3 x 14 + 3 G 18	0,58 - 14,73	91 - 135	212 - 315
33120171037A12	3 x 12 + 3 G 16	0,615 - 15,37	127 - 189	260 - 387
33120171037A10	3 x 10 + 3 G 14	0,67 - 24,8	183 - 272	329 - 490
33120171037A08	3 x 8 + 3 G 14	0,77 - 28,1	246 - 366	441 - 656
33120171037A06	3 x 6 + 3 G 12	0,895 - 31,4	368 - 548	618 - 920
33120171037A04	3 x 4 + 3 G 12	0,995 - 36,1	522 - 777	830 - 1235
33120171037A02	3 x 2 + 3 G 10	1,125 - 38,9	801 - 1192	1152 - 1714
33120171037A1C	3 x 1/0 + 3 G 6	1,385 - 35,18	1348 - 2006	1853 - 2757
33120171037A2C	3 x 2/0 + 3 G 6	1,48 - 37,59	1616 - 2405	2169 - 3227
33120171037A3C	3 x 3/0 + 3 G 5	1,59 - 40,39	2010 - 2991	2619 - 3897
33120171037A4C	3 x 4/0 + 3 G 4	1,78 - 45,21	2517 - 3745	3241 - 4823
33120171037A5C	3 x 250 + 3G 4	1,94 - 49,28	2895 - 4308	3763 - 5599
33120171037A7C	3 x 350 + 3 G 2	2,16 - 54,86	4089 - 6084	5109 - 7602
33120171037AAC	3 x 500 + 3 G 1	2,45 - 62,36	5693 - 8471	6933 - 10316

Other dimension and colours available on request.

GAALFLEX® VFD 9YSLCY-J and 9YSLCYK-J

Inverter, connection to frequency converters, (UV resistant), 0,6/1 kV



Construction:

Conductor:	flexible red copper conductor Cl. 5, acc to IEC 60228, DIN VDE 0295
Insulation:	PP compound
Cores color:	(9YSLCY-J) 4 cores: green/yellow, brown, black, grey (9YSLCYK-J) acc. to DIN VDE 0293-308, HD 308 S2 3 conductors + 3 earth conductors: grey, brown, black and green/yellow divided in interstices
Stranding:	in layers
Screen:	aluminium tape + PETP foil and tinned copper braid
Outer Sheath:	transparent, PVC type YM2 or black (similar RAL 9005), PVC compound

Resistance:



Self-extinguishing and flame retardant acc. to:
DIN VDE 0482 part 265-2-1,
EN 50265-2-1,
IEC 60332-1-2,
UL VW-1, CSA FT-1

Technical data:

Nominal voltage:	U ₀ /U 0,6/1 kV
Nominal voltage UL:	1000 V
Test voltage:	4 kV
Temperature range	
<i>Fixed laying:</i>	- 50 °C up to + 90 °C
<i>Flexible application:</i>	- 5 °C up to + 90 °C
Temperature range UL:	
<i>Fixed laying:</i>	- 40 °C up to + 80 °C
<i>Flexible application:</i>	- 5 °C up to + 80 °C
Min. bending radius	
<i>Single bending:</i>	4 x d
<i>Multiple bending:</i>	20 x d
Insulation resistance:	min. 200 MΩm x km
Transfer impedance at 30 MHz Ω/km:	< 250
Mutual capacitance (4 conductors version):	depending on the cross-section core/core 70 to 250 nF/km core/screen 110 to 410 nF/km

Features:

USA: acc. to NFPA 79 Ed 08
UV resistant (9YSLCYK-J)
outdoor use (9YSLCYK-J)
acc. to EN 61800-3
EN VDE 90°C rated PP insulation
EMC (electromagnetic compatibility)
interconnection between frequency converter and motor
used in paper, chemical and heavy industry
low coupling resistance
UL AWM Style 2570 1000 V 80°C VW-1
UL AWM //III A/B 1000 V 80° FT-1
RoHS and CE approval



Applications:

these motor power supply cables are flexible and have a special EMC performance due a double screened, low capacitance design. Ideal for frequency converters for variable speed. This cables are suitable in dry damp and wet rooms, Good resistance against acids, caustic solution, oils. Suitable for free, as well as static use, not suitable for continuously moving appliance under tensile load or if during flexing, accompanied by guidance.

GAALFLEX® VFD CABLES

GAALFLEX® VFD 9YSLCY-J and 9YSLCYK-J

Inverter, connection to frequency converters, (UV resistant), 0,6/1 kV



Part no.	No. of cores x cross section n x mm ²	Outer Ø Ca. mm ±10%	Copper weight kg/km	Cable weight approx. kg/km	AWG no.*)
33130HT2041A16	4 G 1,5	10,5	87	230	16
33130HT2041A14	4 G 2,5	11,8	133	300	14
33130HT2041A12	4 G 4	13,3	213	485	12
33130HT2041A10	4 G 6	14,9	298	630	10
33130HT2041A08	4 G 10	17,7	460	860	8
33130HT2041A06	4 G 16	21,5	707	1290	6
33130HT2041A04	4 G 25	26,3	1100	1860	4
33130HT2041A02	4 G 35	29,7	1542	2610	2
33130HT2041A01	4 G 50	34,1	2206	2950	1
33130HT2041A2C	4 G 70	40,9	3002	3950	2/0
33130HT2041A3C	4 G 95	45,4	4004	5300	3/0
33130HT2041A4C	4 G 120	49,8	5108	6600	4/0
33130HT2041A5C	4 G 150	56,1	6225	7043	250 MCM
33130HT2041A7C	4 G 185	61,4	7658	8384	350 MCM
33130HT2041A9C	4 G 240	67,9	9940	12150	450 MCM
33140H72037A16	3 x 1,5 + 3 G 0,25	11,4	88	140	16 / 24
33140H72037A14	3 x 2,5 + 3 G 0,5	12,9	130	220	14 / 20
33140H72037A12	3 x 4 + 3 G 0,75	13,6	224	323	12 / 10
33140H72037A10	3 x 6 + 3 G 1	15,2	276	420	10 / 18
33140H72037A08	3 x 10 + 3 G 1,5	17,4	511	615	8 / 16
33140H72037A06	3 x 16 + 3 G 2,5	20	751	819	6 / 14
33140H72037A04	3 x 25 + 3 G 4	24,3	1204	1325	4 / 12
33140H72037A02	3 x 35 + 3 G 6	27,5	1535	1718	2 / 10
33140H72037A01	3 x 50 + 3 G 10	31,1	2156	2399	1 / 8
33140H72037A2C	3 x 70 + 3 G 10	37,1	2980	3056	2/0 / 8
33140H72037A3C	3 x 95 + 3 G 16	40	3953	4162	3/0 / 6
33140H72037A4C	3 x 120 + 3 G 16	42,6	4836	5074	4/0 / 6
33140H72037A5C	3 x 150 + 3 G 25	50	5412	6128	250 MCM / 4
33140H72037A7C	3 x 185 + 3 G 35	55,6	7077	7820	350 MCM / 2

Other dimension and colours available on request.

GAALFLEX® VFD NYCWY

Power cable with concentric copper conductor, connection to frequency converters, 0,6/1 kV



ELETTROTEK KABEL® GAALFLEX® VFD NYCWY

Construction:

Conductor:	solid or stranded red copper conductor Cl. 1 or 2, acc. to IEC 60228, DIN VDE 0295 10-16 mm ² - round solid cores 25-240 mm ² - stranded conductor
Insulation:	PVC type DIV4
Cores color:	acc. to DIN VDE 0293-308, HD 308 S2
Stranding:	in layers
Inner sheath:	filler compound
Screen:	concentric conductor of corrugated copper wires + copper tape
Outer Sheath:	black (similar RAL 9005), PVC type DMV5

Resistance:



Self-extinguishing and flame retardant acc. to:
DIN VDE 0482 part 265-2-1,
EN 50265-2-1,
IEC 60332-1-2





Technical data:

Nominal voltage:	U ₀ /U 0,6/1 kV
Test voltage:	4 kV
Highest voltage:	
<i>Direct current system:</i>	1,8 kV
<i>Alternating current systems, single-phase system:</i>	1,4 kV
<i>One conductor earthed three phase systems:</i>	700 V
<i>One conductor earthed three phase systems:</i>	1,2 kV
<i>With concentric conductor and a cross-section of 240 mm² and above:</i>	3,6 kV
Temperature range	
<i>Fixed laying:</i>	- 30 °C up to + 70 °C
<i>Flexible installation:</i>	- 5 °C up to + 50 °C
Min. bending radius	
<i>Single core:</i>	15 x d
<i>Multi core:</i>	12 x d
Max tensile stress:	50 N/mm ²

Features:

Acc. to DIN VDE 0276 part 603, HD 603 S1
and IEC 60502

RoHS and CE approval

-  re: circular solid conductor
-  rm: circular stranded conductor
-  sm: sector-shaped stranded conductor
-  se: sector-shaped solid conductor



Applications:

suitable especially for underground laying,
for example in subscriber networks, power stations
also as control cable for transmission of control impulses
and test data

GAALFLEX® VFD CABLES

GAALFLEX® VFD NYCWY

Power cable with concentric copper conductor, connection to frequency converters, 0,6/1 kV



ELETTROTEK KABEL® GAALFLEX® VFD NYCWY

Part no.	No. of cores x cross section n x mm ²	Outer Ø Ca. mm ±10%	Copper weight kg/km	Cable weight approx. kg/km	AWG no.*)
33250G73020M61	2 x 10 re / 10	19	312	650	8
33250G73020M62	2 x 16 re / 16	21	489	850	6
33250G73020M63	2 x 25 rm / 25	24	763	1210	4
33250G73030M61	3 x 10 re / 10	19,5	408	730	8
33250G73030M62	3 x 16 re / 16	22	643	1000	6
33250G73030M63	3 x 25 rm / 16	26	902	1550	4
33250G73030M64	3 x 35 sm / 16	27	1190	1750	2
33250G73030M65	3 x 50 sm / 25	29	1723	2250	1
33250G73030M66	3 x 70 sm / 35	33	2410	2950	2/0
33250G73030M67	3 x 95 sm / 50	38	3296	4100	3/0
33250G73030M68	3 x 120 sm / 70	41	4236	5050	4/0
33250G73030M69	3 x 150 sm / 70	45	5100	6000	250 MCM
33250G73030M70	3 x 185 sm / 95	50	6383	7550	350 MCM
33250G73030M71	3 x 240 sm / 120	57	8242	9950	450 MCM
33251G73030M63	3 x 25 rm / 25	26	1003	1600	4
33251G73030M64	3 x 35 sm / 35	27,5	1402	1850	2
33251G73030M65	3 x 50 sm / 50	29,5	2000	2450	1
33251G73030M66	3 x 70 sm / 70	34	2796	3350	2/0
33251G73030M67	3 x 95 sm / 95	38,5	3791	4550	3/0
33251G73030M68	3 x 120 sm / 120	42	4786	5550	4/0
33251G73030M69	3 x 150 sm / 150	46	5970	6900	250 MCM
33251G73030M70	3 x 185 sm / 185	51	7363	8500	350 MCM
33250G73040M61	4 x 10 re / 10	20,5	504	890	8
33250G73040M62	4 x 16 re / 16	23,5	796	1250	6
33250G73040M63	4 x 25 rm / 16	28	1142	1800	4
33250G73040M64	4 x 35 sm / 16	29	1526	2050	2
33250G73040M65	4 x 50 sm / 25	33	2203	2700	1
33250G73040M66	4 x 70 sm / 35	37	3082	3750	2/0
33250G73040M67	4 x 95 sm / 50	43,5	4208	5000	3/0
33250G73040M68	4x120 sm / 70	47,2	5388	6350	4/0
33250G73040M69	4 x 150 sm / 70	51	6540	7650	250 MCM
33250G73040M70	4 x 185 sm / 95	56	8159	9350	350 MCM
33250G73040M71	4 x 240 sm / 120	62,5	10546	11600	450 MCM

Other dimension and colours available on request.

GAALFLEX® VFD 1000 P

Inverter, connection to frequency converters, UV Resistant, 0,6/1 kV

ELETTROTEK KABEL® GAALFLEX® VFD 1000 P

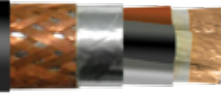

Construction:

Conductor:	flexible red copper conductor Cl. 5, acc to IEC 60228, DIN VDE 0295
Insulation:	GAALTHERM® 530
Cores color:	acc. to DIN VDE 0293-308, HD 308 S2 3 phase cores: brown-black-gray
Stranding:	in layers
Screen:	aluminium tape (100% covering), red copper braid of the same section as the phase conductor (for sections up to 16 mm ²) or equal to half phase conductor, with a minimum of 16 mm ² (for section greater than 25 mm ²)
Outer Sheath:	black (similar RAL 9005), special PUR compound

Resistance:



Self-extinguishing and flame retardant acc. to:
DIN VDE 0482 part 265-2-1,
EN 50265-2-1,
IEC 60332-1-2

Technical data:

Nominal voltage:	U ₀ /U 0,6/1 kV
Test voltage:	4 kV
Temperature range	
<i>Fixed laying:</i>	- 50 °C up to + 90 °C
<i>Flexible installation:</i>	- 40 °C up to + 90 °C
Max. temperature on conductor:	+ 90°C
Max. temperature in short circuit:	+ 250 °C
Min. bending radius	8 x d

Features:

UV resistant
acc. to IEC 60502-1 and CEI 20-13, CEI-UNEL 35375
RoHS and CE approval
On request is possible:
GAALFLEX® VFD 1000 PH, Halogen free Version
Insulation: GAALTHERM® 630



Part no.	No. of cores x cross section n x mm ²	Outer Ø Ca. mm ±10%	Copper weight kg/km	Cable weight approx. kg/km	AWG no.®)
33160G73030M25	3 x 2,5 + SH	14,6	96	340	14
33160G73030M40	3 x 4 + SH	15,8	134	400	12
33160G73030M60	3 x 6 + SH	18,7	231	490	10
33160G73030M61	3 x 10 + SH	21,7	336	720	8
33160G73030M62	3 x 16 + SH	25,3	615	1040	6
33160G73030M63	3 x 25 + SH	28,8	873	1410	4
33160G73030M64	3 x 35 + SH	32,2	1162	1870	2
33160G73030M65	3 x 50 + SH	36	1680	2400	1
33160G73030M66	3 x 70 + SH	40,7	2352	3360	2/0
33160G73030M67	3 x 95 + SH	47,6	3192	4350	3/0
33160G73030M68	3 x 120 + SH	52,2	4032	5540	4/0
33160G73030M69	3 x 150 + SH	56,4	5040	6880	250 MCM
33160G73030M70	3 x 185 + SH	64,8	6216	8350	350 MCM
33160G73030M71	3 x 240 + SH	74,5	8604	11540	450 MCM
33160G73030M72	3 x 300 + SH	85,5	10080	13480	550 MCM

Other dimension and colours available on request.

GAALFLEX® VFD I 200

Inverter, connection to frequency converters, UV Resistant, 0,6/1 kV

ELETTROTEK KABEL® GAALFLEX® VFD 1200

Construction:

Conductor:	stranded red copper conductor Cl. 2, acc to IEC 60228, DIN VDE 0295
Insulation:	GAALTHERM® 590
Cores color:	acc. to DIN VDE 0293-308, HD 308 S2 3 phase cores: brown-black-gray
Stranding:	in layers
Screen:	aluminium tape (100% covering), red copper wires screen wrapped of the same section as the phase conductor (for sections up to 16 mm ²) or equal to half phase conductor, with a minimum of 16 mm ² (for section greater than 25 mm ²)
Outer Sheath:	black (similar RAL 9005), special PUR compound

Resistance:



Self-extinguishing and flame retardant acc. to:
DIN VDE 0482 part 265-2-1,
EN 50265-2-1,
IEC 60332-1-2

Technical data:

Nominal voltage:	U ₀ /U 0,6/1 kV
Test voltage:	4 kV
Temperature range	
<i>Fixed laying:</i>	- 50 °C up to + 90 °C
<i>Flexible installation:</i>	- 40 °C up to + 90 °C
Max. temperature on conductor:	+ 90°C
Max. temperature in short circuit:	+ 250 °C
Min. bending radius	8 x d

Features:

UV resistant
acc. to IEC 60502-1
RoHS and CE approval



Part no.	No. of cores x cross section n x mm ²	Outer Ø Ca. mm ± 10%	Copper weight kg/km	Cable weight approx. kg/km	AWG no.®)
33270G73030M25	3 x 2,5 + SH	14,6	96	340	14
33270G73030M40	3 x 4 + SH	15,8	134	400	12
33270G73030M60	3 x 6 + SH	18,7	231	490	10
33270G73030M61	3 x 10 + SH	21,7	336	720	8
33270G73030M62	3 x 16 + SH	25,3	615	1040	6
33270G73030M63	3 x 25 + SH	28,8	873	1410	4
33270G73030M64	3 x 35 + SH	32,2	1162	1870	2
33270G73030M65	3 x 50 + SH	36	1680	2400	1
33270G73030M66	3 x 70 + SH	40,7	2352	3360	2/0
33270G73030M67	3 x 95 + SH	47,6	3192	4350	3/0
33270G73030M68	3 x 120 + SH	52,2	4032	5540	4/0
33270G73030M69	3 x 150 + SH	56,4	5040	6880	250 MCM
33270G73030M70	3 x 185 + SH	64,8	6216	8350	350 MCM
33270G73030M71	3 x 240 + SH	74,5	8604	11540	450 MCM
33270G73030M72	3 x 300 + SH	85,5	10080	13480	550 MCM

Other dimension and colours available on request.

GAALFLEX® VFD FG7OHH2R

Inverter, connection to frequency converters, 0,6/1 kV

ELETTROTEK KABEL® GAALFLEX® VFD FG7OHH2R



Construction:

- Conductor:** flexible red copper conductor Cl. 5, acc to IEC 60228, DIN VDE 0295
- Insulation:** rubber HEPR compound
- Cores color:** acc. to DIN VDE 0293-308, HD 308 S2
3 phase cores: brown-black-gray
- Stranding:** in layers
- Screen:** aluminium tape (100% covering), red copper braid of the same section as the phase conductor (for sections up to 16 mm²) or equal to half phase conductor, with a minimum of 16 mm² (for section greater than 25 mm²)
- Outer Sheath:** grey (similar RAL 7035), special PVC type RZ

Resistance:



Self-extinguishing and flame retardant acc. to:

DIN VDE 0482 part 265-2-1,
EN 50265-2-1,
IEC 60332-1-2,
DIN VDE 0482 part 266-2-4,
EN 50266-2-4,
IEC 60332-3-24

Technical data:

- Nominal voltage:** U₀/U 0,6/1 kV
- Test voltage:** 4 kV
- Temperature range**
- Fixed laying:* - 15 °C up to + 90 °C
- Flexible installation:* - 0 °C up to + 90 °C
- Max. temperature on conductor:** + 90 °C
- Max. temperature in short circuit:** + 250 °C
- Min. bending radius** 8 x d

Features:

- acc. to IEC 60502-1 and CEI 20-13, CEI-UNEL 35375
- RoHS and CE approval
- On request is possible:
FG7OHH2M1 0,6/1 kV, Halogen free Version
Outer Sheath: green M1 LSZH thermoplastic



Part no.	No. of cores x cross section n x mm ²	Outer Ø Ca. mm ± 10%	Copper weight kg/km	Cable weight approx. kg/km	AWG no.®)
33170G83030M25	3 x 2,5 + SH	14,6	96	340	14
33170G83030M40	3 x 4 + SH	15,8	134	400	12
33170G83030M60	3 x 6 + SH	18,5	231	490	10
33170G83030M61	3 x 10 + SH	21	336	720	8
33170G83030M62	3 x 16 + SH	23,5	615	1040	6
33170G83030M63	3 x 25 + SH	27	873	1410	4
33170G83030M64	3 x 35 + SH	30,5	1162	1870	2
33170G83030M65	3 x 50 + SH	35	1680	2400	1
33170G83030M66	3 x 70+SH	40	2352	3360	2/0
33170G83030M67	3 x 95+SH	45	3192	4350	3/0
33170G83030M68	3 x 120+SH	50	4032	5540	4/0
33170G83030M69	3 x 150+SH	55,4	5040	6880	250 MCM
33170G83030M70	3 x 185+SH	61,5	6216	8350	350 MCM
33170G83030M71	3 x 240+SH	68	8604	11540	450 MCM
33170G83030M72	3 x 300+SH	73,5	10080	13480	550 MCM

Other dimension and colours available on request.

GAALFLEX® VFD FE4OHH2R

Inverter, connection to frequency converters, 0,6/1 kVV

ELETTROTEK KABEL® GAALFLEX® VFD FE4OHH2R

Construction:

- Conductor:** flexible red copper conductor Cl. 5, acc to IEC 60228, DIN VDE 0295
- Insulation:** XLPE compound
- Cores color:** acc. to DIN VDE 0293-308, HD 308 S2
3 phase cores: brown-black-gray
- Stranding:** in layers
- Screen:** aluminium tape (100% covering), red copper braid of the same section as the phase conductor (for sections up to 16 mm²) or equal to half phase conductor, with a minimum of 16 mm² (for section greater than 25 mm²)
- Outer Sheath:** black (similar RAL 7035), special PVC type RZ

Resistance:



Self-extinguishing and flame retardant acc. to:

DIN VDE 0482 part 265-2-1,
EN 50265-2-1,
IEC 60332-1-2,
DIN VDE 0482 part 266-2-4,
EN 50266-2-4,
IEC 60332-3-24

Technical data:

- Nominal voltage:** U₀/U 0,6/1 kV
- Test voltage:** 4 kV
- Temperature range**
- Fixed laying:* - 20 °C up to + 90 °C
- Flexible installation:* - 0 °C up to + 90 °C
- Max. temperature on conductor:** + 90°C
- Max. temperature in short circuit:** + 250 °C
- Min. bending radius** 8 x d

Features:

acc. to IEC 60502-1 and CEI 20-13, CEI-UNEL 35375

RoHS and CE approval



Part no.	No. of cores x cross section n x mm ²	Outer Ø Ca. mm ±10%	Copper weight kg/km	Cable weight approx. kg/km	AWG no.®)
33180G73020M61	2 x 10 / 10	19	312	650	8
33180G73020M62	2 x 16 / 16	21	489	850	6
33180G73020M63	2 x 25 / 25	24	763	1210	4
33180G73030M61	3 x 10 / 10	19,5	408	730	8
33180G73030M62	3 x 16 / 16	22	643	1000	6
33180G73030M63	3 x 25 / 16	26	902	1550	4
33180G73030M64	3 x 35 / 16	27	1190	1750	2
33180G73030M65	3 x 50 / 25	29	1723	2250	1
33180G73030M66	3 x 70 / 35	33	2410	2950	2/0
33180G73030M67	3 x 95 / 50	38	3296	4100	3/0
33180G73030M68	3 x 120 / 70	41	4236	5050	4/0
33180G73030M69	3 x 150 / 70	45	5100	6000	250 MCM
33180G73030M70	3 x 185 / 95	50	6383	7550	350 MCM
33180G73030M71	3 x 240 / 120	57	8242	9950	450 MCM
33182G73030M63	3 x 25 / 25	26	1003	1600	4
33182G73030M64	3 x 35 / 35	27,5	1402	1850	2

GAALFLEX® VFD CABLES

GAALFLEX® VFD FE4OHH2R

Inverter, connection to frequency converters, 0,6/1 kVV

ELETTROTEK KABEL® GAALFLEX® VFD FE4OHH2R

Part no.	No. of cores x cross section n x mm ²	Outer Ø Ca. mm ±10%	Copper weight kg/km	Cable weight approx. kg/km	AWG no.*)
33182G73030M65	3 x 50 / 50	29,5	2000	2450	1
33182G73030M66	3 x 70 / 70	34	2796	3350	2/0
33182G73030M67	3 x 95 / 95	38,5	3791	4550	3/0
33182G73030M68	3 x 120 / 120	42	4786	5550	4/0
33182G73030M69	3 x 150 / 150	46	5970	6900	250 MCM
33182G73030M70	3 x 185 / 185	51	7363	8500	350 MCM
33180G73040M61	4 x 10 / 10	20,5	504	890	8
33180G73040M62	4 x 16 / 16	23,5	796	1250	6
33180G73040M63	4 x 25 / 16	28	1142	1800	4
33180G73040M64	4 x 35 / 16	29	1526	2050	2
33180G73040M65	4 x 50 / 25	33	2203	2700	1
33180G73040M66	4 x 70 / 35	37	3082	3750	2/0
33180G73040M67	4 x 95 / 50	43,5	4208	5000	3/0
33180G73040M68	4x120 / 70	47,2	5388	6350	4/0
33180G73040M69	4 x 150 / 70	51	6540	7650	250 MCM
33180G73040M70	4 x 185 / 95	56	8159	9350	350 MCM
33180G73040M71	4 x 240 / 120	62,5	10546	11600	450 MCM

Other dimension and colours available on request.

GAALFLEX® VFD FG7(O)CR

Inverter, connection to frequency converters, 0,6/1 kV

ELETTROTEK KABEL® GAALFLEX® VFD FG7(O)CR



Construction:

Conductor:	flexible red copper conductor Cl. 5, acc to IEC 60228, DIN VDE 0295
Insulation:	rubber HEPR compound
Cores color:	acc. to DIN VDE 0293-308, HD 308 S2 3 phase cores: brown-black-gray
Stranding:	in layers
Inner sheath:	PVC type R2
Screen:	red copper braid of the same section as the phase conductor (for sections up to 16 mm ²) or equal to half phase conductor, with a minimum of 16 mm ² (for section greater than 25 mm ²)
Outer Sheath:	grey (similar RAL 7035), special PVC compound

Resistance:



Self-extinguishing and flame retardant acc. to:

DIN VDE 0482 part 265-2-1,
EN 50265-2-1,
IEC 60332-1-2,
DIN VDE 0482 part 266-2-4,
EN 50266-2-4,
IEC 60332-3-24

Technical data:

Nominal voltage:	U ₀ /U 0,6/1 kV
Test voltage:	4 kV
Temperature range	
<i>Fixed laying:</i>	- 15 °C up to + 90 °C
<i>Flexible installation:</i>	- 0 °C up to + 90 °C
Max. temperature on conductor:	+ 90°C
Max. temperature in short circuit:	+ 250 °C
Min. bending radius	8 x d

Features:

acc. to IEC 60502-1 and CEI 20-13, CEI-UNEL 35375

RoHS and CE approval



Part no.	No. of cores x cross section n x mm ²	Outer Ø Ca. mm ±10%	Copper weight kg/km	Cable weight approx. kg/km	AWG no. *)
33190G83030M25	3 x 2,5 + SH	14,6	96	340	14
33190G83030M40	3 x 4 +SH	15,8	134	400	12
33190G83030M60	3 x 6 + SH	18,7	231	490	10
33190G83030M61	3 x 10 + SH	21,7	336	720	8
33190G83030M62	3 x 16 + SH	25,3	615	1040	6
33190G83030M63	3 x 25 + SH	28,8	873	1410	4
33190G83030M64	3 x 35 + SH	32,2	1162	1870	2
33190G83030M65	3 x 50 + SH	36	1680	2400	1
33190G83030M66	3x70+SH	40,7	2352	3360	2/0
33190G83030M67	3x95+SH	47,6	3192	4350	3/0
33190G83030M68	3x120+SH	52,2	4032	5540	4/0
33190G83030M69	3x150+SH	56,4	5040	6880	250 MCM
33190G83030M70	3x185+SH	64,8	6216	8350	350 MCM
33190G83030M71	3x240+SH	74,5	8604	11540	450 MCM
33190G83030M72	3x300+SH	85,5	10080	13480	550 MCM

Other dimension and colours available on request.

GAALFLEX® VFD CABLES

GAALFLEX® VFD FE4(O)CR

Inverter, connection to frequency converters, 0,6/1 kV

ELETTROTEK KABEL® GAALFLEX® VFD FE4(O)CR

Construction:

Conductor:	flexible red copper conductor Cl. 5, acc to IEC 60228, DIN VDE 0295
Insulation:	XLPE compound
Cores color:	acc. to DIN VDE 0293-308, HD 308 S2 3 phase cores: brown-black-gray
Stranding:	in layers
Inner sheath:	PVC type R2
Screen:	red copper braid of the same section as the phase conductor (for sections up to 16 mm ²) or equal to half phase conductor, with a minimum of 16 mm ² (for section greater than 25 mm ²)
Outer Sheath:	grey (similar RAL 7035), special PVC compound

Resistance:



Self-extinguishing and flame retardant acc. to:

DIN VDE 0482 part 265-2-1,
EN 50265-2-1,
IEC 60332-1-2,
DIN VDE 0482 part 266-2-4,
EN 50266-2-4,
IEC 60332-3-24

Technical data:

Nominal voltage:	U ₀ /U 0,6/1 kV
Test voltage:	4 kV
Temperature range	
<i>Fixed laying:</i>	- 20 °C up to + 90 °C
<i>Flexible installation:</i>	- 0 °C up to + 90 °C
Max. temperature on conductor:	+ 90°C
Max. temperature in short circuit:	+ 250 °C
Min. bending radius	8 x d

Features:

acc. to IEC 60502-1 and CEI 20-13, CEI-UNEL 35375

RoHS and CE approval



Part no.	No. of cores x cross section n x mm ²	Outer Ø Ca. mm ±10%	Copper weight kg/km	Cable weight approx. kg/km	AWG no.®)
33200G83030M25	3 x 2,5 + SH	14,6	96	340	14
33200G83030M40	3 x 4 + SH	15,8	134	400	12
33200G83030M60	3 x 6 + SH	18,7	231	490	10
33200G83030M61	3 x 10 + SH	21,7	336	720	8
33200G83030M62	3 x 16 + SH	25,3	615	1040	6
33200G83030M63	3 x 25 + SH	28,8	873	1410	4
33200G83030M64	3 x 35 + SH	32,2	1162	1870	2
33200G83030M65	3 x 50 + SH	36	1680	2400	1
33200G83030M66	3 x 70 + SH	40,7	2352	3360	2/0
33200G83030M67	3 x 95 + SH	47,6	3192	4350	3/0
33200G83030M68	3 x 120 + SH	52,2	4032	5540	4/0
33200G83030M69	3 x 150 + SH	56,4	5040	6880	250 MCM
33200G83030M70	3 x 185 + SH	64,8	6216	8350	350 MCM
33200G83030M71	3 x 240 + SH	74,5	8604	11540	450 MCM
33200G83030M72	3 x 300 + SH	85,5	10080	13480	550 MCM

Other dimension and colours available on request.

GAALFLEX® VFD EMV-FC 3GSEGCY

Medium voltage motor power supply cables, overall copper screen, 3,6/6 kV and 6/10 kV

ELETTROTEK KABEL® GAALFLEX® VFD EMV-FC 3GSEGCY



Construction:

Conductor:	stranded red copper conductor Cl. 2, acc. to IEC 60228, DIN VDE 0295	
Inner semi-conductive layer:	semi-conductive rubber compound, acc. to IEC 60502-2	
Insulation:	rubber EPR compound acc. To IEC 60502-2	
Outer semi-conductive layer:	semi-conductive rubber compound, acc. to IEC 60502-2	
Cores identification:	numerical 1-2-3 imprint on the outer semi-conductive layer	
Screen:	two red copper tapes <i>conductor cross section:</i> <i>screen cross. section:</i> 35 to 120 mm ² 16 mm ² > 120 mm ² 25 mm ²	
Inner sheath:	black, polyolefin compound acc. to IEC 60502-2	
Concentric overall copper screen:	red copper wires and one or two copper tape(s) applied helically <i>screen cross section:</i> approx. 0,5 conductor cross-section (electrical)	
Outer Sheath:	red (similar RAL 3005), PVC type ST2 acc. to IEC 60502-1	

Resistance:



Self-extinguishing and flame retardant acc. to:
DIN VDE 0482 part 265-2-1,
EN 50265-2-1,
IEC 60332-1-2

Technical data:

Nominal voltage:	U ₀ /U 3,6/6 kV U ₀ /U 6/10 kV
Test voltage:	U ₀ /U 3,6/6 kV / 21kV U ₀ /U 6/10 kV / 29 kV
Temperature range:	- 30 °C up to + 70 °C
Installation temperature range:	- 10 °C up to + 50 °C
Max. temperature on conductor:	+ 90°C
Max. temperature in short circuit:	+ 250 °C
Min. bending radius:	10 x d
Current carrying capacity:	acc. to DIN VDE 0276-620 6
Tensile strength:	up to 50 N/mm ²
(RFI) and RFI-voltage:	EMC-optimized cables acc. to DIN EN 55011/DIN 0875 part. 11, classes A1 and B1

Features:

on request:
acc. to DIN VDE 0482 part 266-2-2 / EN 50266-2-2 /
IEC 60332-3/22
identified with "5 " on the 5th number of the Part no.

On request is possible:
GAALSHOCK technology version

RoHS approval



Applications:

for frequency converter controlled AC drives.
For fixed installation outdoor as well as indoors in dry,
damp and wet conditions and in explosion hazard areas.
This cable can be installed directly in ground

GAALFLEX® VFD EMV-FC 3GSEGCY

Medium voltage motor power supply cables, overall copper screen, 3,6/6 kV and 6/10 kV

ELETTROTEK KABEL® GAALFLEX® VFD EMV-FC 3GSEGCY



3,6/6 kV

Part no.	No. of cores x cross section n x mm ²	Outer Ø Ca. mm ±10%	Copper weight kg/km	Cable weight approx. kg/km	AWG no.*)
33210MR1030M64	3 x 35	45,5	1330	3500	2
33210MR1030M65	3 x 50	48	1835	4200	1
33210MR1030M66	3 x 70	52,5	2510	5200	2/0
33210MR1030M67	3 x 95	56,5	3350	6400	3/0
33210MR1030M68	3 x 120	60	4190	7600	4/0
33210MR1030M69	3 x 150	64	5280	8700	250 MCM
33210MR1030M70	3 x 185	68	6460	10500	350 MCM
33210MR1030M71	3 x 240	73,5	8310	13000	450 MCM

6/10 kV

Part no.	No. of cores x cross section n x mm ²	Outer Ø Ca. mm ±10%	Copper weight kg/km	Cable weight approx. kg/km	AWG no.*)
33210QR1030M70	3 x 185/95	76,3	6642	11880	350 MCM

Other dimension and colours available on request.

GAALFLEX® VFD EMV-FC 3GSEGCH

Medium voltage motor power supply cables, halogen-free, overall copper screen, 3,6/6 kV



ELETTROTEK KABEL® GAALFLEX® VFD EMV-FC 3GSEGCH



Construction:

Conductor:	stranded red copper conductor Cl. 2, acc to IEC 60228, DIN VDE 0295
Inner semi-conductive layer:	semi-conductive rubber compound, acc. to IEC 60502-2
Insulation:	rubber EPR compound acc. to IEC 60502-2
Outer semi-conductive layer:	semi-conductive rubber compound, acc. to IEC 60502-2
Cores identification:	numerical 1-2-3 imprint on the outer semi-conductive layer
Screen:	two red copper tapes <i>conductor cross section:</i> 35 to 120 mm ² <i>screen cross. section:</i> 16 mm ² > 120 mm ² 25 mm ²
Inner sheath:	black, polyolefin compound acc. to IEC 60502-2
Concentric overall copper screen:	red copper wires and one or two copper tape(s) applied helically <i>screen cross section:</i> approx. 0,5 conductor cross-section (electrical)
Outer Sheath:	red (similar RAL 3005), halogen-free type ST8, acc. to IEC 60502-1

Technical data:

Nominal voltage:	U ₀ /U 3,6/6 kV
Test voltage:	21 kV
Max. perm. voltage U:	14,6 kV
<i>for connection on 3 level frequency converters with a nominal voltage:</i>	6,6 kV
Temperature range:	- 30 °C up to + 70 °C
Installation temperature range:	- 10 °C up to + 50 °C
Max. temperature on conductor:	+ 90°C
Max. temperature in short circuit:	+ 250 °C
Min. bending radius	10 x d
Current carrying capacity:	acc. to DIN VDE 0276-620 6
Tensile strength:	up to 50 N/mm ²
(RFI) and RFI-voltage:	EMC-optimized cables acc. to DIN EN 55011/DIN 0875 part. 11, classes A1 and B1

Resistance:



Self-extinguishing and flame retardant acc. to:
DIN VDE 0482 part 265-2-1,
EN 50265-2-1,
IEC 60332-1-2,
DIN VDE 0482 part 266-2-2,
EN 50266-2-2,
IEC 60332-3-22



Halogen-free acc. to:
DIN VDE 0482 part 267,
EN 50267-2-1,
IEC 60754-1



Smoke density acc. to:
DIN VDE 0482 part 268-1/-2,
EN 50268-1/-2,
DIN EN 61034-1+2,
IEC 61034-1+2 part 1+2

Features:

On request is possible:
GAALSHOCK technology version

RoHS approval



Applications:

for frequency converter controlled AC drives.
For fixed installation outdoor as well as indoors in dry,
damp and wet conditions and in explosion hazard areas.
This cable can be installed directly in ground or in water

GAALFLEX® VFD CABLES

GAALFLEX® VFD EMV-FC 3GSEGCH

Medium voltage motor power supply cables, halogen-free, overall copper screen, 3,6/6 kV



ELETTROTEK KABEL® GAALFLEX® VFD EMV-FC 3GSEGCH

Part no.	No. of cores x cross section n x mm ²	Outer Ø Ca. mm ±10%	Copper weight kg/km	Cable weight approx. kg/km	AWG no.*)
33220MR1030M64	3 x 35	45,5	1330	3500	2
33220MR1030M65	3 x 50	48	1835	4200	1
33220MR1030M66	3 x 70	52,5	2510	5200	2/0
33220MR1030M67	3 x 95	56,5	3350	6400	3/0
33220MR1030M68	3 x 120	60	4190	7600	4/0
33220MR1030M69	3 x 150	64	5280	8700	250 MCM
33220MR1030M70	3 x 185	68	6460	10500	350 MCM
33220MR1030M71	3 x 240	73,5	8310	13000	450 MCM

GAALFLEX® VFD EMV-FC 2XSEHCHRH

Medium voltage motor power supply cables, halogen-free, overall copper screen and steel wire armouring, 3,6/6 kV



ELETTROTEK KABEL® GAALFLEX® VFD EMV-FC 2XSEHCHRH



Construction:

- Conductor:** stranded red copper conductor Cl. 2, acc to IEC 60228, DIN VDE 0295
- Inner semi-conductive layer:** semi-conductive rubber compound
- Insulation:** XLPE compound
- Outer semi-conductive layer:** semi-conductive rubber compound
- Cores identification:** numerical 1-2-3
imprint on the outer semi-conductive layer
- Screen:** two red copper tapes
conductor cross section: 35 to 120 mm²
screen cross section: 16 mm²
> 120 mm² 25 mm²
- 1st Inner sheath:** black (RAL 9005), halogen-free compound
- Concentric overall copper screen:** red copper wires and one or two copper tape(s) applied helically
screen cross section: approx. 0,5 conductor cross-section (electrical)
- 2nd Inner sheath:** black (similar RAL 9005), halogen-free compound
- Armouring:** galvanized steel wires
- Outer Sheath:** black (similar RAL 9005), halogen-free compound

Technical data:

- Nominal voltage:** U₀/U 3,6/6 kV
- Test voltage:** 21 kV
- Max. perm. voltage U:** 14,6 kV
for connection on 3 level frequency converters with a nominal voltage: 6,6 kV
- Temperature range:** - 30 °C up to + 90 °C
- Installation temperature range:** - 10 °C up to + 50 °C
- Max. temperature on conductor:** + 90°C
- Max. temperature in short circuit:** + 250 °C
- Min. bending radius** 10 x d
- Current carrying capacity:** acc. to DIN VDE 0276-620 6
- Max. tensile strenght:** up to 50 N/mm²
- (RFI) and RFI-voltage:** EMC-optimized cables acc. to DIN EN 55011/DIN 0875 part. 11, classes A1 and B1

Resistance:



Self-extinguishing and flame retardant acc. to:

DIN VDE 0482 part 265-2-1,
EN 50265-2-1,
IEC 60332-1-2,
DIN VDE 0482 part 266-2-2,
EN 50266-2-2,
IEC 60332-3-22



Halogen-free acc. to:

DIN VDE 0482 part 267,
EN 50267-2-1,
IEC 60754-1



Corrosiveness of conflagration gases:

acc. to DIN VDE 0482 part 267,
EN 50267-2-2,
IEC 60754-2



Smoke density acc. to:

DIN VDE 0482 part 268-1/-2,
EN 50268-1/-2,
DIN EN 61034-1+2,
IEC 61034-1+2 part 1+2

Features:

- UV resistant
- acc. to IEC 60502-1
- RoHS approval



Applications:

for frequency converter controlled AC drives. For fixed installation outdoor as well as indoors in dry, damp and wet conditions and in explosion hazard areas. This cable can be installed directly in ground

Part no.	No. of cores x cross section n x mm ²	Outer Ø Ca. mm ±10%	Copper weight kg/km	Cable weight approx. kg/km	AWG no.*)
33260M71030M69	3 x 150	67,6	4859	10744	350 MCM

Other dimension and colours available on request.

GAALFLEX® VFD 600

XLPE/PVC, Low voltage variable frequency drive systems, 600 V



ELETTROTEK KABEL® GAALFLEX® VFD 600

UL standard 44
UL standard 1277



Construction:

Conductor:	stranded red copper, acc.to ASTM B-3 and ASTM B-8
Insulation:	XLPE compound, acc. to UL 44 and VW-1 flame test
Earth conductor:	stranded red copper, acc.to ASTM B-3 and ASTM B-8
Cores color:	acc. to ICEA S-73-352 (NEMA WC 57) black conductors with number print
Stranding:	in layers + fillers + 3 earth conductor in interstices
Screen :	corrugated red copper tape
Outer Sheath:	black (similar RAL 9005), PVC compound, heat and moisture resistant acc. to UL1581 and UL 1277

Technical data:

Nominal voltage UL:	600 V
Temperature range	
<i>Fixed laying:</i>	- 40 °C up to + 90 °C
<i>Flexible installation:</i>	- 5 °C up to + 90 °C
Min. bending radius:	12 x d

Resistance:



Flame test acc. to:
IEEE 1202 , Flame test
ICEA T-29-520, Flame test

Features:

MSHA APPROVED

On request is possible:
2000 V nominal voltage version
Optional features are:

1. EPR insulation
2. CPE, LSZH or TPE Outer sheath

RoHS approval



UL Standards:

UL standard 44
UL standard 1277

Applications:

these cables are designed for use with low voltage (600 V) AC motors controlled for speed by modern PWM inverters.

Part no.	No. of cores x cross section n x AWG/MCM	Outer Ø Inches/mm ±10%	Cable weight approx. Lbs/Mft-kg/km
33230F70037A16	3 x 16 + 3 x 18	0,43 - 10,9	92 - 136
33230F70037A14	3 x 14 + 3 x 18	0,46 - 11,7	144 - 213
33230F70037A12	3 x 12 + 3 x 18	0,519 - 13	176 - 260
33230F70037A10	3 x 10 + 3 x 16	0,59 - 15	254 - 376
33230F70037A08	3 x 8 + 3 x 14	0,73 - 18,5	390 - 577
33230F70037A06	3 x 6 + 3 x 12	0,78 - 19,8	263 - 389
33230F70037A04	3 x 4 + 3 x 10	0,93 - 23,6	769 - 1138
33230F70037A02	3 x 2 + 3 x 8	1,11 - 28,2	1154 - 1655
33230F70037A01	3 x 1 + 3 x 8	1,28 - 32,5	1427 - 2112
33230F70037A1C	3 x 1/0 + 3 x 6	1,37 - 34,8	1764 - 2611)
33230F70037A2C	3 x 2/0 + 3 x 6	1,43 - 36,3	2077 - 3074
33230F70037A3C	3 x 3/0 + 3 x 4	1,55 - 39,4	2599 - 3847
33230F70037A4C	3 x 4/0 + 3 x 4	1,66 - 42,2	3093 - 4578
33230F70037A5C	3 x 250 MCM+ 3 x 4	1,88 - 47,8	3791 - 5611
33230F70037A7C	3 x 350 MCM + 3 x 2	2 - 50,8	5020 - 7430
33230F70037AAC	3 x 500 MCM + 3 x 1	2,3 - 58,4	7012 - 10378

Other dimension and colours available on request.

GAALFLEX® SAFE



GAALFLEX® SAFE

PVC control cable blue outer sheath, 300/500 V

ELETTROTEK KABEL® GAALFLEX® SAFE



Construction:

Conductor:	flexible red copper conductor Cl.5, acc.to IEC 60228, DIN VDE 0295
Insulation:	PVC type Tl2 acc. to DIN VDE 0281 part 1 + HD 21.1
Colour cores:	black cores with consecutive numbers acc. to EN 50334
Stranding:	in layers
Outer sheath:	blue (RAL 5015), PVC type TM2, acc. to DIN VDE 0281 part 1 + HD 21.1

Resistance:



Self-extinguishing and flame retardant acc. to:
DIN VDE 0482 part 332-1-2
EN 60332-1-2
IEC 60332-1-2



Oil resistance acc. to:
DIN VDE 0473 part 811-2-1
IEC EN 60811-2-1

Technical data:

Nominal voltage:	UoU 300/500 V
Test voltage:	3 kV acc.to DIN VDE 0281 part 2 + HD 21.2
Temperature range	
<i>Fixed laying:</i>	-40°C up to +70°C
<i>Flexible installation:</i>	+5°C up to +70°C
Min. bending radius	
<i>Fixed laying:</i>	4 x d
<i>Flexible installation:</i>	7,5 x d
Radiation resistance:	8 x 10 ⁷ cJ/kg

Features:

for hazardous areas to hazard type -i-
for intrinsically safe circuits,
acc. to DIN EN 60079-14 and IEC 60079-14
section 12.2.2., VDE 0165 part 1

RoHS and CE approval



GAALFLEX® SAFE

PVC control cable blue outer sheath, 300/500V

ELETTROTEK KABEL® GAALFLEX® SAFE



Part no.	No. of cores x cross section n x mm ²	Outer-Ø ca. mm ± 10%	Copper weight kg/km	Cable weight approx. kg/km	AWG no. *)
34010DB1020M07	2 x 0,75	5,2	14,4	46	19
34010DB1030M07	3 x 0,75	5,5	21,6	54	19
34010DB1040M07	4 x 0,75	6,2	29	66	19
34010DB1050M07	5 x 0,75	6,8	36	80	19
34010DB1070M07	7 x 0,75	8,1	52	110	19
34010DB1080M07	8 x 0,75	8,9	58	130	19
34010DB1120M07	12 x 0,75	9,9	88	179	19
34010DB1180M07	18 x 0,75	11,9	130	257	19
34010DB1250M07	25 x 0,75	14,5	180	365	19
34010DB1300M07	30 x 0,75	15,8	215	448	19
34010DB1340M07	34 x 0,75	16,4	245	510	19
34010DB1410M07	41 x 0,75	17,6	298	607	19
34010DB1020M10	2 x 1	5,5	19	60	18
34010DB1030M10	3 x 1	6	29	72	18
34010DB1040M10	4 x 1	6,6	38	86	18
34010DB1050M10	5 x 1	7,2	48	104	18
34010DB1070M10	7 x 1	8,6	67	141	18
34010DB1120M10	12 x 1	10,7	115	230	18
34010DB1180M10	18 x 1	12,7	173	343	18
34010DB1250M10	25 x 1	15,6	240	485	18
34010DB1020M15	2 x 1,5	6,3	29	70	16
34010DB1030M15	3 x 1,5	6,7	43	90	16
34010DB1040M15	4 x 1,5	7,3	58	109	16
34010DB1050M15	5 x 1,5	8,2	72	131	16
34010DB1070M15	7 x 1,5	9,8	101	184	16
34010DB1120M15	12 x 1,5	12,1	173	309	16
34010DB1180M15	18 x 1,5	14,5	259	440	16
34010DB1250M15	25 x 1,5	17,8	360	620	16
34010DB1300M15	30 x 1,5	20	440	842	16
34010DB1030M15	3 x 2,5	8,3	72	148	14
34010DB1040M15	4 x 2,5	9,1	96	178	14
34010DB1050M15	5 x 2,5	10,2	120	221	14

Other dimensions and colors available on request.

GAALFLEX® SAFE CY Lean

PVC control cable blue outer sheath and overall copper screen, 300/500 V

ELETTROTEK KABEL® GAALFLEX® SAFE CY Lean



Construction:

Conductor:	flexible red copper conductor Cl.5, acc.to IEC 60228, DIN VDE 0295
Insulation:	PVC type Tl2 acc. to DIN VDE 0281 part 1 + HD 21.1
Colour cores:	black cores with consecutive numbers acc. to EN 50334
Stranding:	in layers
Screen:	tinned copper braid
Outer sheath:	blue (RAL 5015), PVC type TM2, acc. to DIN VDE 0281 part 1 + HD 21.1

Resistance:



Self-extinguishing and flame retardant acc. to:
DIN VDE 0482 part 332-1-2
EN 60332-1-2
IEC 60332-1-2



Oil resistance acc. to:
DIN VDE 0473 part 811-2-1
IEC EN 60811-2-1

Technical data:

Nominal voltage:	UoU 300/500 V
Test voltage:	3 kV acc.to DIN VDE 0281 part 2 + HD 21.2
Temperature range	
<i>Fixed laying:</i>	-40°C up to +80°C
<i>Flexible installation:</i>	+5°C up to +80°C
Min. bending radius	
<i>Fixed laying:</i>	5 x d
<i>Flexible installation:</i>	10 x d
Radiation resistance:	8 x 10 ⁷ cJ/kg

Features:

for hazardous areas to hazard type -i- for intrinsically safe circuits, acc. to DIN EN 60079-14 and IEC 60079-14 section 12.2.2., VDE 0165 part 1

RoHS and CE approval



GAALFLEX® SAFE CY Lean

PVC control cable blue outer sheath and overall copper screen, 300/500V

ELETTROTEK KABEL® GAALFLEX® SAFE CY Lean

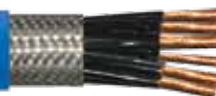

Part no.	No. of cores x cross section n x mm ²	Outer-Ø ca. mm ± 10%	Copper weight kg/km	Cable weight approx. kg/km	AWG no. *)
34020DB1020M07	2 x 0,75	6,1	40	59	19
34020DB1030M07	3 x 0,75	6,4	52	66	19
34020DB1040M07	4 x 0,75	6,9	60	77	19
34020DB1050M07	5 x 0,75	7,4	71	93	19
34020DB1070M07	7 x 0,75	8,6	91	130	19
34020DB1080M07	8 x 0,75	9,4	110	145	19
34020DB1100M07	10 x 0,75	10,2	137	180	19
34020DB1120M07	12 x 0,75	10,4	142	202	19
34020DB1180M07	18 x 0,75	12,4	212	292	19
34020DB1200M07	20 x 0,75	12,9	238	362	19
34020DB1250M07	25 x 0,75	15,1	281	415	19
34020DB1300M07	30 x 0,75	15,6	320	486	19
34020DB1340M07	34 x 0,75	16,9	345	523	19
34020DB1410M07	41 x 0,75	18,3	400	680	19
34020DB1020M10	2 x 1	6,4	50	65	18
34020DB1030M10	3 x 1	6,7	60	81	18
34020DB1040M10	4 x 1	7,3	71	98	18
34020DB1050M10	5 x 1	7,8	88	127	18
34020DB1070M10	7 x 1	9,1	111	158	18
34020DB1120M10	12 x 1	11,2	184	260	18
34020DB1180M10	18 x 1	13,2	260	380	18
34020DB1250M10	25 x 1	16,2	349	534	18
34020DB1340M10	34 x 1	18	468	741	18
34020DB1020M15	2 x 1,5	6,8	63	88	16
34020DB1030M15	3 x 1,5	7,3	80	100	16
34020DB1040M15	4 x 1,5	8,1	97	126	16
34020DB1050M15	5 x 1,5	8,9	119	160	16
34020DB1070M15	7 x 1,5	10,5	147	208	16
34020DB1120M15	12 x 1,5	12,8	267	338	16
34020DB1180M15	18 x 1,5	15,2	374	479	16
34020DB1250M15	25 x 1,5	18,5	526	705	16
34020DB1300M15	30 x 1,5	19	555	830	16
34020DB1340M15	34 x 1,5	20,8	629	900	16

Other dimensions and colors available on request.

GAALFLEX® SAFE CY TP

paired PVC control cable blue outer sheath and overall copper screen, 300/500 V

ELETTROTEK KABEL® GAALFLEX® SAFE CY TP

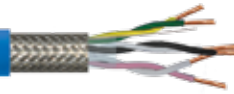

Construction:

Conductor:	flexible red copper conductor Cl.5, acc.to IEC 60228, DIN VDE 0295
Insulation:	PVC type YI2 acc. to DIN VDE 0207 part 4
Colour cores:	acc. to DIN 47100
Stranding:	cores twisted in pairs, pairs stranded layers
Screen:	tinned copper braid + PETP foil
Outer sheath:	blue (RAL 5015) PVC type YM2 acc. to DIN VDE 0207 part 5

Resistance:



Self-extinguishing and flame retardant acc. to:
DIN VDE 0482 part 332-1-2
EN 60332-1-2
IEC 60332-1-2



Oil resistance acc. to:
DIN VDE 0473 part 811-2-1
IEC EN 60811-2-1

Technical data:

Nominal voltage:	0.14 mm ² = max.350V 0.25 mm ² = max 500 V
Test voltage:	0.14 mm ² = max 1,2 kV 0.25 mm ² = max 2 kV
Breakdown voltage:	0.14 mm ² = max 2,4 kV 0.25 mm ² = max 2,4 kV
Temperature range	
<i>Fixed laying:</i>	-30°C up to +80°C
<i>Flexible installation:</i>	+5°C up to +80°C
Min. bending radius	
<i>Fixed laying:</i>	12 x d
<i>Flexible installation:</i>	6 x d
Radiation resistance:	up to 80 x 10 ⁶ cJ/kg (up to 80 Mrad)
Mutual capacitance:	
<i>Core/core:</i>	0.14 mm ² = 147 pf/m 0.25 mm ² = 152.5 pf/m
<i>Core/screen:</i>	0.14 mm ² = 147 pf/m 0.25 mm ² = 263 pf/m
Impedence:	0.14 mm ² = 536 Ohm/1 kHz/20°C 0.25 mm ² = 396 Ohm/1 kHz/20°C
Coupling:	250 pF/100 m/1 kHz
Screen resistance:	0.14 mm ² = 36 Ohm/km 0.25 mm ² = 18 Ohm/km

Features:

for hazardous areas to hazard type -i-
for intrinsically safe circuits,
acc. to DIN EN 60079-14 and IEC 60079-14
section 12.2.2., VDE 0165 part 1

RoHS and CE approval



GAALFLEX® SAFE CY TP

paired PVC control cable blue outer sheath and overall copper screen, 300/500 V

ELETTROTEK KABEL® GAALFLEX® SAFE CY TP

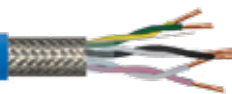

Part no.	No. of cores x cross section n x mm ²	Outer-Ø ca. mm ± 10%	Copper weight kg/km	Cable weight approx. kg/km	AWG no. *)
34030CB4022M05	2 x 2 x 0,5	8	47	89	20
34030CB4032M05	3 x 2 x 0,5	8,4	67	104	20
34030CB4042M05	4 x 2 x 0,5	9,1	80	126	20
34030CB4062M05	6 x 2 x 0,5	10,7	108	171	20
34030CB4082M05	8 x 2 x 0,5	13	129	251	20
34030CB4102M05	10 x 2 x 0,5	14,2	172	282	20
34030CB4122M05	12 x 2 x 0,5	14,4	235	261	20
34030CB4162M05	16 x 2 x 0,5	17,7	301	445	20
34030CB4202M05	20 x 2 x 0,5	19,2	343	525	20
34030CB4242M05	24 x 2 x 0,5	20,7	394	590	20
34030CB4252M05	25 x 2 x 0,5	20,9	406	622	20
34030CB4022M07	2 x 2 x 0,75	8,7	60	105	19
34030CB4032M07	3 x 2 x 0,75	9,2	80	128	19
34030CB4042M07	4 x 2 x 0,75	10	110	156	19
34030CB4062M07	6 x 2 x 0,75	11,1	142	216	19
34030CB4082M07	8 x 2 x 0,75	14,6	200	308	19
34030CB4102M07	10 x 2 x 0,75	16	238	355	19
34030CB4122M07	12 x 2 x 0,75	16,4	270	405	19
34030CB4162M07	16 x 2 x 0,75	20	342	560	19
34030CB4202M07	20 x 2 x 0,75	21,6	369	671	19
34030CB4242M07	24 x 2 x 0,75	24,3	451	795	19
34030CB4252M07	25 x 2 x 0,75	24,4	461	803	19

Other dimensions and colors available on request.

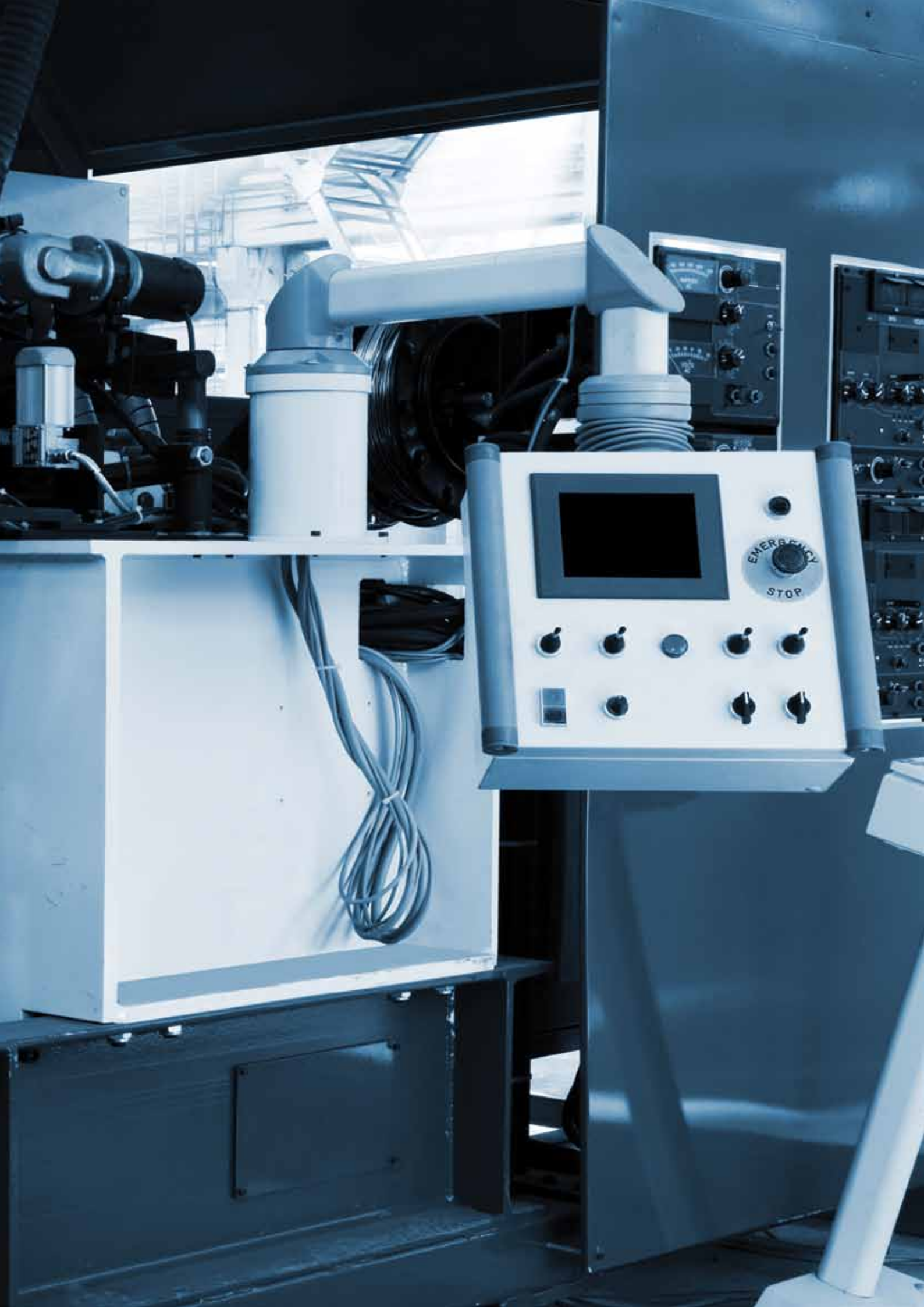

DATA CABLES



DATA CABLES

GAALFLEX® DATA LiYY

PVC data cable

ELETTROTEK KABEL® GAALFLEX® DATA LiYY



Construction:

Conductor:	flexible red copper conductor Cl.5, acc.to IEC 60228, DIN VDE 0295
Insulation:	PVC type T11, acc. to DIN VDE 0207 part. 4
Colour cores:	acc. to DIN 47100
Stranding:	in layers
Outer sheath:	grey (RAL 7001),PVC type TM2, acc. to DIN VDE 0207 part. 5

Resistance:



Self-extinguishing and flame retardant acc. to:
DIN VDE 0482 part 265-2-1
EN 50265-2-1
IEC 60332-1-2



Oil resistance acc. to:
DIN VDE 0473 part 811-2-1
IEC EN 60811-2-1

Technical data:

Nominal voltage:	< 0,34 mm ² = 250 V max.350 V ≥ 0,34 mm ² = 300/500 V
Test voltage:	< 0,34 mm ² = max. 800 V ≥ 0,34 mm ² = max. 1,2 kV
Temperature range	
<i>Fixed laying:</i>	- 30°C up to +70°C
<i>Flexible installation:</i>	- 5°C up to + 70°C
Min. bending radius	
<i>Fixed laying:</i>	5 x d
<i>Flexible installation:</i>	10 x d
Radiation resistance:	8 x 10 ⁷ cJ/kg

Features:

on request tinned copper conductor
on request grey (RAL 7032)
Flexible
small outer diameter
small bending radius
RoHS and CE approval



Part no.	No.of cores x cross section n x mm ²	Outer-Ø ca.mm ± 10%	Copper weight kg/km	Cable weight approx. kg/km	AWG no.*)
35010C54020M01	2 x 0,14	3,1	2,7	13	26
35010C54030M01	3 x 0,14	3,3	4	15	26
35010C54040M01	4 x 0,14	3,5	5,4	17	26
35010C54050M01	5 x 0,14	3,8	6,7	21	26
35010C54060M01	6 x 0,14	4,1	8,1	25	26
35010C54070M01	7 x 0,14	4,1	9,4	25	26
35010C54080M01	8 x 0,14	4,7	10,8	33	26
35010C54100M01	10 x 0,14	5,1	13,4	34	26
35010C54120M01	12 x 0,14	5,3	16,1	39	26
35010C54140M01	14 x 0,14	5,5	18,8	44	26
35010C54160M01	16 x 0,14	6,0	21,5	53	26
35010C54180M01	18 x 0,14	6,3	24,2	59	26
35010C54200M01	20 x 0,14	6,6	26,9	65	26
35010C54210M01	21 x 0,14	6,9	28,2	69	26
35010C54240M01	24 x 0,14	7,3	32,3	73	26
35010C54250M01	25 x 0,14	7,7	33,6	79	26
35010C54270M01	27 x 0,14	7,7	36,3	83	26
35010C54300M01	30 x 0,14	7,9	40,3	90	26
35010C54320M01	32 x 0,14	8,2	43	97	26
35010C54360M01	36 x 0,14	8,5	48,4	107	26
35010C54400M01	40 x 0,14	9,1	53,8	119	26
35010C54440M01	44 x 0,14	9,5	59,1	126	26
35010C54480M01	48 x 0,14	10,1	64,5	144	26
35010C54500M01	50 x 0,14	10,3	67,2	149	26
35010C54520M01	52 x 0,14	10,3	69,9	154	26
35010C54560M01	56 x 0,14	10,6	75,3	165	26
35010C54610M01	61 x 0,14	10,9	82	175	26

DATA CABLES

GAALFLEX® DATA LiYY

PVC data cable

ELETTROTEK KABEL® GAALFLEX® DATA LiYY



Part no.	No. of cores x cross section n x mm ²	Outer-Ø ca. mm ± 10%	Copper weight kg/km	Cable weight approx. kg/km	AWG no. *)
35010C54020M02	2 x 0,25	3,4	4,8	16	24
35010C54030M02	3 x 0,25	3,6	7,2	20	24
35010C54040M02	4 x 0,25	3,9	9,6	24	24
35010C54050M02	5 x 0,25	4,2	12,	29	24
35010C54060M02	6 x 0,25	4,6	14,4	34	24
35010C54070M02	7 x 0,25	4,6	16,8	35	24
35010C54080M02	8 x 0,25	5,2	19,2	45	24
35010C54090M02	9 x 0,25	5,6	21,6	51	24
35010C54100M02	10 x 0,25	5,9	24	51	24
35010C54120M02	12 x 0,25	6,1	28,8	58	24
35010C54140M02	14 x 0,25	6,4	33,6	66	24
35010C54160M02	16 x 0,25	6,7	38,4	74	24
35010C54180M02	18 x 0,25	7,1	43,2	83	24
35010C54200M02	20 x 0,25	7,6	48,0	95	24
35010C54210M02	21 x 0,25	7,9	50,4	100	24
35010C54240M02	24 x 0,25	8,4	57,6	108	24
35010C54250M02	25 x 0,25	8,6	60	112	24
35010C54270M02	27 x 0,25	8,6	64,8	119	24
35010C54300M02	30 x 0,25	8,9	72	131	24
35010C54320M02	32 x 0,25	9,2	76,8	139	24
35010C54360M02	36 x 0,25	10	86,4	163	24
35010C54400M02	40 x 0,25	10,6	96	181	24
35010C54440M02	44 x 0,25	11,1	105,6	192	24
35010C54480M02	48 x 0,25	11,3	115,2	206	24
35010C54500M02	50 x 0,25	11,6	120	214	24
35010C54520M02	52 x 0,25	11,6	124,8	221	24
35010C54560M02	56 x 0,25	11,9	134,4	237	24
35010C54610M02	61 x 0,25	12,3	146,4	254	24
35010D54020M03	2 x 0,34	4	6,5	23	22
35010D54030M03	3 x 0,34	4,2	9,8	27	22
35010D54040M03	4 x 0,34	4,6	13,1	33	22
35010D54050M03	5 x 0,34	5	16,3	41	22
35010D54060M03	6 x 0,34	5,5	19,6	49	22
35010D54070M03	7 x 0,34	5,5	22,8	51	22
35010D54080M03	8 x 0,34	6,5	26,1	67	22
35010D54100M03	10 x 0,34	7,1	32,6	72	22
35010D54120M03	12 x 0,34	7,3	39,2	83	22
35010D54140M03	14 x 0,34	7,9	45,7	98	22
35010D54160M03	16 x 0,34	8,3	52,2	111	22
35010D54180M03	18 x 0,34	8,8	58,8	124	22
35010D54200M03	20 x 0,34	9,2	65,3	137	22
35010D54210M03	21 x 0,34	10	68,5	153	22
35010D54240M03	24 x 0,34	10,6	78,3	165	22
35010D54250M03	25 x 0,34	10,8	81,6	170	22
35010D54270M03	27 x 0,34	10,8	88,1	181	22
35010D54300M03	30 x 0,34	11,2	97,9	197	22
35010D54320M03	32 x 0,34	11,6	104,4	210	22
35010D54360M03	36 x 0,34	12,1	117,5	234	22
35010D54400M03	40 x 0,34	12,9	130,6	261	22
35010D54440M03	44 x 0,34	13,5	143,6	277	22
35010D54480M03	48 x 0,34	13,7	156,7	298	22
35010D54520M03	52 x 0,34	14,5	169,7	333	22
35010D54560M03	56 x 0,34	14,9	182,8	356	22
35010D54610M03	61 x 0,34	15,4	199,1	382	22

DATA CABLES

GAALFLEX® DATA LiYY

PVC data cable

ELETTROTEK KABEL® GAALFLEX® DATA LiYY



Part no.	No. of cores x cross section n x mm ²	Outer-Ø ca. mm ± 10%	Copper weight kg/km	Cable weight approx. kg/km	AWG no. *)
35010D54020M05	2 x 0,50	4,3	9,6	27	20
35010D54030M05	3 x 0,50	4,5	14,4	33	20
35010D54040M05	4 x 0,50	4,9	19,2	40	20
35010D54050M05	5 x 0,50	5,4	24	50	20
35010D54060M05	6 x 0,50	6,1	28,8	62	20
35010D54070M05	7 x 0,50	6,1	33,6	65	20
35010D54080M05	8 x 0,50	7,1	38,4	83	20
35010D54100M05	10 x 0,50	7,9	48	92	20
35010D54120M05	12 x 0,50	8,1	57,6	106	20
35010D54140M05	14 x 0,50	8,5	67,2	120	20
35010D54160M05	16 x 0,50	9	76,8	137	20
35010D54180M05	18 x 0,50	9,5	86,4	152	20
35010D54200M05	20 x 0,50	10,4	96	178	20
35010D54210M05	21 x 0,50	10,9	100,8	189	20
35010D54240M05	24 x 0,50	11,5	115,2	203	20
35010D54250M05	25 x 0,50	11,7	120	210	20
35010D54270M05	27 x 0,50	11,7	129,6	223	20
35010D54300M05	30 x 0,50	12,1	144	244	20
35010D54320M05	32 x 0,50	12,6	153,6	261	20
35010D54360M05	36 x 0,50	13,1	172,8	290	20
35010D54400M05	40 x 0,50	14,5	192	337	20
35010D54440M05	44 x 0,50	15,1	211,2	358	20
35010D54480M05	48 x 0,50	15,3	230,4	384	20
35010D54520M05	52 x 0,50	15,7	249,6	412	20
35010D54560M05	56 x 0,50	16,2	268,8	442	20
35010D54610M05	61 x 0,50	16,7	292,8	475	20
35010D54020M07	2 x 0,75	4,9	14,4	37	19
35010D54030M07	3 x 0,75	5,2	21,6	45	19
35010D54040M07	4 x 0,75	5,9	28,8	58	19
35010D54050M07	5 x 0,75	6,4	36	71	19
35010D54060M07	6 x 0,75	7	43,2	84	19
35010D54070M07	7 x 0,75	7	50,4	89	19
35010D54080M07	8 x 0,75	8,3	57,6	116	19
35010D54100M07	10 x 0,75	9,1	72	127	19
35010D54120M07	12 x 0,75	9,4	86,4	146	19
35010D54140M07	14 x 0,75	10,3	100,8	175	19
35010D54160M07	16 x 0,75	10,8	115,2	198	19
35010D54180M07	18 x 0,75	11,4	129,6	221	19
35010D54210M07	21 x 0,75	12,5	151,2	260	19
35010D54240M07	24 x 0,75	13,3	172,8	280	19
35010D54270M07	27 x 0,75	13,6	194,4	309	19
35010D54300M07	30 x 0,75	14,5	216	351	19
35010D54320M07	32 x 0,75	15	230,4	375	19
35010D54360M07	36 x 0,75	15,6	259,2	417	19
35010D54020M10	2 x 1	5,1	19,2	43	18
35010D54030M10	3 x 1	5,4	28,8	54	18
35010D54040M10	4 x 1	6,1	38,4	70	18
35010D54050M10	5 x 1	6,7	48	87	18
35010D54060M10	6 x 1	7,3	57,6	103	18
35010D54070M10	7 x 1	7,3	67,2	110	18
35010D54020M15	2 x 1,5	5,6	28,8	54	16
35010D54030M15	3 x 1,5	6,1	43,2	70	16
35010D54040M15	4 x 1,5	6,7	57,6	87	16
35010D54050M15	5 x 1,5	7,7	72	115	16
35010D54060M15	6 x 1,5	8,4	86,4	136	16
35010D54070M15	7 x 1,5	8,4	100,8	146	16

Other dimension and colours available on request.

GAALFLEX® DATA LIYCY

PVC data cable with overall copper screen

ELETTROTEK KABEL® GAALFLEX® DATA LIYCY



Construction:

Conductor:	flexible red copper conductor Cl.5, acc.to IEC 60228, DIN VDE 0295
Insulation:	PVC type T11, acc. to DIN VDE 0207 part. 4
Colour cores:	acc. to DIN 47100
Stranding:	in layers
Wrapping:	PETP foil
Screen:	tinned copper braid
Outer sheath:	grey (RAL 7001),PVC type TM2, acc. to DIN VDE 0207 part. 5

Resistance:



Self-extinguishing and flame retardant acc. to:

DIN VDE 0482 part 265-2-1
EN 50265-2-1
IEC 60332-1-2



Oil resistance acc. to:

DIN VDE 0473 part 811-2-1
IEC EN 60811-2-1

Technical data:

Nominal voltage:	< 0,34 mm ² = 250 V max.350 V ≥ 0,34 mm ² = 300/500 V
Test voltage:	< 0,34 mm ² = max. 800 V ≥ 0,34 mm ² = max. 1,2 kV
Temperature range	
<i>Fixed laying:</i>	- 30°C up to +70°C
<i>Flexible installation:</i>	- 5°C up to + 70°C
Min. bending radius	
<i>Fixed laying:</i>	5 x d
<i>Flexible installation:</i>	10 x d
Radiation resistance:	8 x 10 ⁷ cJ/kg

Features:

on request tinned copper conductor
on request grey (RAL 7032)
good EMC characteristics
flexible
small outer diameter
small bending radius
RoHS and CE approval



Part no	No.of cores x cross section n x mm ²	Outer-Ø ca.mm ± 10%	Copper weight kg/km	Cable weight approx. kg/km	AWG no.*)
35020C54020M01	2 x 0,14	3,6	12,6	18	26
35020C54030M01	3 x 0,14	3,8	14,1	21	26
35020C54040M01	4 x 0,14	4	15,9	24	26
35020C54050M01	5 x 0,14	4,3	19,5	29	26
35020C54060M01	6 x 0,14	4,6	22	33	26
35020C54070M01	7 x 0,14	4,6	24	33	26
35020C54080M01	8 x 0,14	5,4	26	44	26
35020C54100M01	10 x 0,14	5,8	29	47	26
35020C54120M01	12 x 0,14	6,2	32	55	26
35020C54140M01	14 x 0,14	6,4	35	61	26
35020C54160M01	16 x 0,14	6,7	49	69	26
35020C54180M01	18 x 0,14	7	54	75	26
35020C54200M01	20 x 0,14	7,3	58	82	26
35020C54210M01	21 x 0,14	7,6	60	87	26
35020C54240M01	24 x 0,14	8	74	92	26
35020C54250M01	25 x 0,14	8,6	78	102	26
35020C54270M01	27 x 0,14	8,6	85	106	26
35020C54300M01	30 x 0,14	8,8	98	116	26
35020C54320M01	32 x 0,14	9,1	108	122	26
35020C54360M01	36 x 0,14	9,4	117	133	26
35020C54400M01	40 x 0,14	10	126	148	26
35020C54440M01	44 x 0,14	10,6	138	168	26
35020C54480M01	48 x 0,14	10,8	145	177	26
35020C54500M01	50 x 0,14	11	150	183	26
35020C54520M01	52 x 0,14	11	155	187	26
35020C54560M01	56 x 0,14	11,3	166	202	26
35020C54610M01	61 x 0,14	11,6	176	213	26

DATA CABLES

GAALFLEX® DATA LiYCY

PVC data cable with overall copper screen

ELETTROTEK KABEL® GAALFLEX® DATA LiYCY



Part no.	No. of cores x cross section n x mm ²	Outer-Ø ca. mm ± 10%	Copper weight kg/km	Cable weight approx. kg/km	AWG no. *)
35020C54010M02	1 x 0,25	2,7	8	13	24
35020C54020M02	2 x 0,25	3,9	15	23	24
35020C54030M02	3 x 0,25	4,1	18	26	24
35020C54040M02	4 x 0,25	4,4	22	31	24
35020C54050M02	5 x 0,25	4,9	25	38	24
35020C54060M02	6 x 0,25	5,3	30	45	24
35020C54070M02	7 x 0,25	5,3	32	46	24
35020C54080M02	8 x 0,25	6,1	35	59	24
35020C54090M02	9 x 0,25	6,5	39	57	24
35020C54100M02	10 x 0,25	6,6	42	65	24
35020C54120M02	12 x 0,25	6,8	50	73	24
35020C54140M02	14 x 0,25	7,1	64	81	24
35020C54150M02	15 x 0,25	7,4	68	90	24
35020C54160M02	16 x 0,25	7,4	71	91	24
35020C54180M02	18 x 0,25	7,8	80	102	24
35020C54200M02	20 x 0,25	8,5	96	117	24
35020C54210M02	21 x 0,25	8,8	105	125	24
35020C54240M02	24 x 0,25	9,3	115	133	24
35020C54250M02	25 x 0,25	9,5	117	139	24
35020C54270M02	27 x 0,25	9,5	120	145	24
35020C54300M02	30 x 0,25	9,8	132	157	24
35020C54320M02	32 x 0,25	10,1	138	166	24
35020C54360M02	36 x 0,25	10,7	152	195	24
35020C54400M02	40 x 0,25	11,3	164	217	24
35020C54440M02	44 x 0,25	11,8	180	229	24
35020C54480M02	48 x 0,25	12,4	209	254	24
35020C54500M02	50 x 0,25	12,7	222	262	24
35020C54520M02	52 x 0,25	12,7	234	269	24
35020C54560M02	56 x 0,25	13	259	288	24
35020C54610M02	61 x 0,25	13,4	287	306	24
35020D54020M03	2 x 0,34	4,5	17	29	22
35020D54030M03	3 x 0,34	4,9	21	35	22
35020D54040M03	4 x 0,34	5,3	25	43	22
35020D54050M03	5 x 0,34	5,7	30	52	22
35020D54060M03	6 x 0,34	6,4	37	64	22
35020D54070M03	7 x 0,34	6,4	42	65	22
35020D54080M03	8 x 0,34	7,2	45	81	22
35020D54100M03	10 x 0,34	7,8	63	89	22
35020D54120M03	12 x 0,34	8,0	70	100	22
35020D54140M03	14 x 0,34	8,8	78	121	22
35020D54160M03	16 x 0,34	9,2	87	134	22
35020D54180M03	18 x 0,34	9,7	108	150	22
35020D54200M03	20 x 0,34	10,1	124	163	22
35020D54210M03	21 x 0,34	10,7	127	185	22
35020D54240M03	24 x 0,34	11,3	140	200	22
35020D54250M03	25 x 0,34	12,1	144	259	22
35020D54270M03	27 x 0,34	11,5	151	216	22
35020D54300M03	30 x 0,34	11,9	162	233	22
35020D54320M03	32 x 0,34	12,7	171	257	22
35020D54360M03	36 x 0,34	13,2	188	285	22
35020D54400M03	40 x 0,34	14	208	316	22
35020D54420M03	42 x 0,34	14	215	326	22
35020D54440M03	44 x 0,34	14,6	223	334	22
35020D54480M03	48 x 0,34	14,8	243	355	22
35020D54500M03	50 x 0,34	15,8	248	402	22
35020D54520M03	52 x 0,34	15,8	273	412	22
35020D54560M03	56 x 0,34	16,2	292	437	22
35020D54610M03	61 x 0,34	16,7	316	464	22

DATA CABLES

GAALFLEX® DATA LiYCY

PVC data cable with overall copper screen

ELETTROTEK KABEL® GAALFLEX® DATA LiYCY



Part no.	No. of cores x cross section n x mm ²	Outer-Ø ca. mm ± 10%	Copper weight kg/km	Cable weight approx. kg/km	AWG no. *)
35020D54010M05	1 x 0,5	3,2	13,3	19	20
35020D54020M05	2 x 0,5	5	23,5	36	20
35020D54030M05	3 x 0,5	5,2	28,4	42	20
35020D54040M05	4 x 0,5	5,6	35,1	51	20
35020D54050M05	5 x 0,5	6,3	41,6	64	20
35020D54060M05	6 x 0,5	6,8	48,3	75	20
35020D54070M05	7 x 0,5	6,8	53,1	78	20
35020D54080M05	8 x 0,5	7,8	62	99	20
35020D54100M05	10 x 0,5	8,8	74,5	115	20
35020D54120M05	12 x 0,5	9	84,2	128	20
35020D54140M05	14 x 0,5	9,4	93,5	143	20
35020D54160M05	16 x 0,5	9,9	105,9	162	20
35020D54180M05	18 x 0,5	10,6	133,9	191	20
35020D54200M05	20 x 0,5	11,1	143,8	208	20
35020D54210M05	21 x 0,5	11,6	154,9	224	20
35020D54240M05	24 x 0,5	12,6	169,7	248	20
35020D54250M05	25 x 0,5	12,8	174,6	256	20
35020D54270M05	27 x 0,5	12,8	184,2	269	20
35020D54300M05	30 x 0,5	13,2	203,6	293	20
35020D54320M05	32 x 0,5	13,7	213,5	311	20
35020D54360M05	36 x 0,5	14,2	239,0	344	20
35020D54400M05	40 x 0,5	15,8	289,4	416	20
35020D54420M05	42 x 0,5	15,8	299,0	429	20
35020D54500M05	50 x 0,5	17	349,7	487	20
35020D54520M05	52 x 0,5	17	359,3	500	20
35020D54610M05	61 x 0,5	18	403,7	565	20
35020D54010M07	1 x 0,75	3,5	15,7	22	19
35020D54020M07	2 x 0,75	5,6	30,3	45	19
35020D54030M07	3 x 0,75	6,1	37,6	56	19
35020D54040M07	4 x 0,75	6,6	46,5	68	19
35020D54050M07	5 x 0,75	7,1	55,7	83	19
35020D54060M07	6 x 0,75	7,7	66,8	99	19
35020D54070M07	7 x 0,75	7,7	74	103	19
35020D54080M07	8 x 0,75	9,2	83,8	136	19
35020D54100M07	10 x 0,75	10	101,1	150	19
35020D54120M07	12 x 0,75	10,5	133,9	183	19
35020D54140M07	14 x 0,75	11	148,5	203	19
35020D54160M07	16 x 0,75	11,5	169,2	231	19
35020D54180M07	18 x 0,75	12,4	184	264	19
35020D54210M07	21 x 0,75	13,6	211	307	19
35020D54240M07	24 x 0,75	14,4	239,1	333	19
35020D54270M07	27 x 0,75	14,7	260,9	363	19
35020D54300M07	30 x 0,75	15,8	313,4	428	19
35020D54320M07	32 x 0,75	16,3	328,3	453	19
35020D54360M07	36 x 0,75	16,9	357,8	496	19
35020D54010M10	1 x 1	3,5	18,2	25	18
35020D54020M10	2 x 1	5,8	35,2	50	18
35020D54030M10	3 x 1	6,3	46,4	64	18
35020D54040M10	4 x 1	6,8	57,9	79	18
35020D54050M10	5 x 1	7,4	69,6	96	18
35020D54060M10	6 x 1	8	81,3	113	18
35020D54070M10	7 x 1	8	90,9	120	18
35020D54010M15	1 x 1,5	3,8	24,7	31	16
35020D54020M15	2 x 1,5	6,5	46,5	68	16
35020D54030M15	3 x 1,5	6,8	62,7	79	16
35020D54040M15	4 x 1,5	7,4	79,2	98	16
35020D54050M15	5 x 1,5	8,6	95,8	131	16
35020D54060M15	6 x 1,5	9,3	112,7	155	16
35020D54070M15	7 x 1,5	9,3	127,1	164	16

Other dimension and colours available on request.

DATA CABLES

GAALFLEX® DATA LiYCY-CY

PVC data cable with individual and overall copper screen, 350/500V

ELETTROTEK KABEL® GAALFLEX® DATA LiYCY-CY



Construction:

Conductor:	flexible red copper conductor Cl.5, acc.to IEC 60228, DIN VDE 0295
Insulation:	PVC type Yl2, acc. to DIN VDE 0207 part. 4
Colour cores:	acc. to DIN 47100
Stranding:	cores twisted in pairs, pairs twisted in layers
Individual screen:	pairs screened individually with tinned copper braid
Insulation pair:	PVC compound
Wrapping:	PETP foil
Screen:	tinned copper braid
Outer sheath:	grey (RAL 7001),PVC type YM2, acc. to DIN VDE 0207 part. 5

Resistance:



Self-extinguishing and flame retardant acc. to:
DIN VDE 0482 part 265-2-1
EN 50265-2-1
IEC 60332-1-2



Oil resistance acc. to:
DIN VDE 0473 part 811-2-1
IEC EN 60811-2-1

Technical data:

Nominal voltage:	0,14 mm ² = max.350V ≥ 0,25 mm ² = max 500 V
Test voltage:	0,14 mm ² = max 1,2 kV ≥ 0,25 mm ² = max 2 kV
Breakdown voltage:	0,14 mm ² = max. 2,4 kV ≥ 0,25 mm ² = max. 4kV
Temperature range	
<i>Fixed laying:</i>	- 40°C up to +80°C
<i>Flexible installation:</i>	- 5°C up to + 80°C
Min. bending radius	
<i>Fixed laying:</i>	6 x d
<i>Flexible installation:</i>	12 x d
Radiation resistance:	8 x 10 ⁻⁷ cJ/kg
Conductor resistance:	0,14 mm ² = 138 Ohm/km ≥ 0,25 mm ² = 77,8 Ohm/km
Screen resistance:	0,14 mm ² = 36 Ohm/km ≥ 0,25 mm ² = 18 Ohm/km
Mutual capacitance	
<i>Core/core:</i>	0,14 mm ² = 147 p _p f/m ≥ 0,25 mm ² = 152.5 p _p f/m
<i>Core/screen</i>	0,14 mm ² = 147 p _p f/m ≥ 0,25 mm ² = 263 p _p f/m
Impedence:	0,14 mm ² = 536 Ohm/1 kHz/20°C ≥ 0,25 mm ² = 396 Ohm/1 kHz/20°C
Coupling:	250 pF/100 m/1 kHz

Features:

on request tinned copper conductor
good EMC characteristics
flexible
small outer diameter
small bending radius
RoHS and CE approval



Applications:

this cable type offers total interference-free data transfer and is ideal for use as a signal and control cable in combination with computers and external units

DATA CABLES

GAALFLEX® DATA LiYCY-CY

PVC data cable with individual and overall copper screen, 350/500V

ELETTROTEK KABEL® GAALFLEX® DATA LiYCY-CY



Part no.	No. of cores x cross section n x mm ²	Outer-Ø ca. mm ± 10%	Copper weight kg/km	Cable weight approx. kg/km	AWG no. *)
35100C54022M01	2 x 2 x 0,14	7,3	31	95	26
35100C54032M01	3 x 2 x 0,14	7,5	34	105	26
35100C54042M01	4 x 2 x 0,14	9,3	45	140	26
35100C54052M01	5 x 2 x 0,14	10,5	58	160	26
35100C54062M01	6 x 2 x 0,14	11	61	185	26
35100C54072M01	7 x 2 x 0,14	11	78	230	26
35100C54082M01	8 x 2 x 0,14	13	97	245	26
35100C54092M01	9 x 2 x 0,14	14,1	101	280	26
35100C54102M01	10 x 2 x 0,14	14	108	325	26
35100C54122M01	12 x 2 x 0,14	15	134	380	26
35100C54162M01	16 x 2 x 0,14	17	179	440	26
35100C54202M01	20 x 2 x 0,14	17,8	225	520	26
35100C54022M02	2 x 2 x 0,25	9,5	62	125	24
35100C54032M02	3 x 2 x 0,25	10	78,2	140	24
35100C54042M02	4 x 2 x 0,25	12	124,1	205	24
35100C54052M02	5 x 2 x 0,25	12,1	137,6	230	24
35100C54062M02	6 x 2 x 0,25	13	148,1	275	24
35100C54072M02	7 x 2 x 0,25	16	159,1	295	24
35100C54082M02	8 x 2 x 0,25	17	178,7	330	24
35100C54102M02	10 x 2 x 0,25	17,2	213,9	420	24
35100C54122M02	12 x 2 x 0,25	17,5	238	465	24
35100C54162M02	16 x 2 x 0,25	22	291,4	590	24
35100C54202M02	20 x 2 x 0,25	22,6	325	620	24
35100C54242M02	24 x 2 x 0,25	27,5	367	690	24
35100C54322M02	32 x 2 x 0,25	29,8	588	785	24
35100C54482M02	48 x 2 x 0,25	34,5	840,5	970	24
35100D54022M03	2 x 2 x 0,34	10,1	73,1	139	22
35100D54032M03	3 x 2 x 0,34	11	88,1	157	22
35100D54042M03	4 x 2 x 0,34	12,4	137,2	213	22
35100D54062M03	6 x 2 x 0,34	14,5	174,8	308	22
35100D54082M03	8 x 2 x 0,34	17,6	247,2	385	22
35100D54102M03	10 x 2 x 0,34	17,6	288,7	433	22
35100D54122M03	12 x 2 x 0,34	18,5	321	495	22
35100D54142M03	14 x 2 x 0,34	20,7	388,4	600	22
35100D54162M03	16 x 2 x 0,34	22,5	425,5	637	22
35100D54242M03	24 x 2 x 0,34	28	577,1	781	22
35100D54022M05	2 x 2 x 0,50	10,8	83,1	143	20
35100D54032M05	3 x 2 x 0,50	11,4	106,4	179	20
35100D54042M05	4 x 2 x 0,50	13	158	241	20
35100D54062M05	6 x 2 x 0,50	14,9	201,4	319	20
35100D54082M05	8 x 2 x 0,50	18,8	311,5	441	20
35100D54102M05	10 x 2 x 0,50	18	334,5	464	20
35100D54122M05	12 x 2 x 0,50	20,1	394,1	529	20
35100D54142M05	14 x 2 x 0,50	21,6	446	641	20
35100D54162M05	16 x 2 x 0,50	23,8	501,2	694	20
35100D54242M05	24 x 2 x 0,50	28,4	712,4	930	20

Other dimension and colours available on request.

GAALFLEX® DATA LiYCY (B) TP

paired PVC data cable with drain wire and overall copper screen

ELETTROTEK KABEL® GAALFLEX® DATA LiYCY B TP

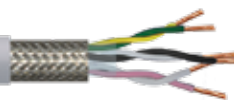

Construction:

Conductor:	flexible red copper conductor Cl.5, acc.to IEC 60228, DIN VDE 0295
Insulation:	PVC type T11, acc. to DIN VDE 0207 part. 4
Colour cores:	acc. to DIN 47100
Stranding:	cores twisted in pairs, pairs twisted in layers
Wrapping:	PETP foil
Screen:	tinned copper braid + tinned copper drain wire (0,34mm ²)
Outer sheath:	grey (RAL 7001),PVC type TM2, acc. to DIN VDE 0207 part. 5

Resistance:



Self-extinguishing and flame retardant acc. to:
DIN VDE 0482 part 265-2-1
EN 50265-2-1
IEC 60332-1-2



Oil resistance acc. to:
DIN VDE 0473 part 811-2-1
IEC EN 60811-2-1

Technical data:

Nominal voltage:	< 0,34 mm ² = 250 V max.350 V ≥ 0,34 mm ² = 300/500 V
Test voltage:	< 0,34 mm ² = max. 800 V ≥ 0,34 mm ² = max. 1,2 kV
Temperature range	
<i>Fixed laying:</i>	- 30°C up to +70°C
<i>Flexible installation:</i>	- 5°C up to + 70°C
Min. bending radius	
<i>Fixed laying:</i>	6 x d
<i>Flexible installation:</i>	15 x d
Radiation resistance:	8 x 10 ⁷ cJ/kg

Features:

- on request tinned copper conductor
- on request grey (RAL 7032)
- good EMC characteristics
- flexible
- small outer diameter
- small bending radius
- RoHS and CE approval



DATA CABLES

GAALFLEX® DATA LiYCY (B) TP

paired PVC data cable with drain wire and overall copper screen

ELETTROTEK KABEL® GAALFLEX® DATA LiYCY B TP

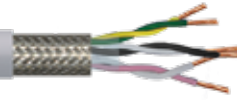

Part no.	No. of cores x cross section n x mm ²	Outer-Ø ca. mm ± 10%	Copper weight kg/km	Cable weight approx. kg/km	AWG no. *)
35030C54022M01	2 x 2 x 0,14	5,2	19,1	34	26
35030C54032M01	3 x 2 x 0,14	5,7	23,4	41	26
35030C54042M01	4 x 2 x 0,14	6,5	27,8	53	26
35030C54052M01	5 x 2 x 0,14	7	31,9	60	26
35030C54062M01	6 x 2 x 0,14	7,2	36,2	68	26
35030C54082M01	8 x 2 x 0,14	7,8	43,4	80	26
35030C54102M01	10 x 2 x 0,14	8,9	50,6	100	26
35030C54122M01	12 x 2 x 0,14	9,7	58,2	111	26
35030C54162M01	16 x 2 x 0,14	10,5	71,4	136	26
35030C54182M01	18 x 2 x 0,14	11,1	92,8	159	26
35030C54202M01	20 x 2 x 0,14	11,1	98,1	164	26
35030C54242M01	24 x 2 x 0,14	12,8	114,8	203	26
35030C54252M01	25 x 2 x 0,14	12,8	117,5	207	26
35030C54282M01	28 x 2 x 0,14	13,1	125,7	221	26
35030C54302M01	30 x 2 x 0,14	13,8	135,6	237	26
35030C54362M01	36 x 2 x 0,14	14,6	157,8	275	26
35030C54402M01	40 x 2 x 0,14	14,9	168,2	296	26
35030C54442M01	44 x 2 x 0,14	16,3	205,9	348	26
35030C54522M01	52 x 2 x 0,14	17	228,1	388	26
35030C54612M01	61 x 2 x 0,14	18,3	263,2	443	26
35030C54022M02	2 x 2 x 0,25	5,7	24,9	42	24
35030C54032M02	3 x 2 x 0,25	6,4	31,4	55	24
35030C54042M02	4 x 2 x 0,25	7,8	44,9	81	24
35030C54062M02	6 x 2 x 0,25	7,9	50,7	85	24
35030C54082M02	8 x 2 x 0,25	9	62,1	109	24
35030C54102M02	10 x 2 x 0,25	9,8	73,9	132	24
35030C54122M02	12 x 2 x 0,25	10,9	101,9	160	24
35030C54162M02	16 x 2 x 0,25	11,9	126,8	195	24
35030C54182M02	18 x 2 x 0,25	12,7	136,6	222	24
35030C54242M02	24 x 2 x 0,25	14,2	170,3	270	24
35030D54022M03	2 x 2 x 0,34	6,8	31,5	57	22
35030D54032M03	3 x 2 x 0,34	7,4	39,7	72	22
35030D54042M03	4 x 2 x 0,34	8,8	49,8	99	22
35030D54052M03	5 x 2 x 0,34	9,5	58,5	116	22
35030D54062M03	6 x 2 x 0,34	9,7	65,1	128	22
35030D54082M03	8 x 2 x 0,34	10,6	80,7	144	22
35030D54122M03	12 x 2 x 0,34	13,4	133,1	225	22
35030D54162M03	16 x 2 x 0,34	14,6	165	280	22
35030D54182M03	18 x 2 x 0,34	15,1	178,3	306	22
35030D54242M03	24 x 2 x 0,34	17,6	255,1	415	22
35030D54022M05	2 x 2 x 0,5	7,2	39,3	66	20
35030D54032M05	3 x 2 x 0,5	7,9	50,1	84	20
35030D54042M05	4 x 2 x 0,5	9,6	82	126	20
35030D54062M05	6 x 2 x 0,5	10,4	86	146	20
35030D54082M05	8 x 2 x 0,5	10,9	111,5	166	20
35030D54102M05	10 x 2 x 0,5	13,2	146,5	229	20
35030D54122M05	12 x 2 x 0,5	14,4	175,7	268	20
35030D54162M05	16 x 2 x 0,5	16,3	241,3	368	20
35030D54182M05	18 x 2 x 0,5	16,9	261	399	20
35030D54202M05	20 x 2 x 0,5	16,9	280,2	418	20
35030D54242M05	24 x 2 x 0,5	19	330,4	491	20
35030D54022M07	2 x 2 x 0,75	8,5	52,4	92	19
35030D54032M07	3 x 2 x 0,75	9,4	69,4	112	19
35030D54042M07	4 x 2 x 0,75	10,9	108	179	19
35030D54062M07	6 x 2 x 0,75	12,5	136,5	218	19
35030D54082M07	8 x 2 x 0,75	14,9	180	305	19
35030D54122M07	12 x 2 x 0,75	17,1	261,2	385	19
35030D54162M07	16 x 2 x 0,75	18,6	329,9	482	19
35030D54182M07	18 x 2 x 0,75	19,3	369,3	535	19
35030D54242M07	24 x 2 x 0,75	21,8	469,2	661	19
35030D54022M10	2 x 2 x 1	9,4	70	120	18
35030D54032M10	3 x 2 x 1	10	90	150	18
35030D54042M10	4 x 2 x 1	10,4	110	180	18
35030D54052M10	5 x 2 x 1	12,1	150	240	18
35030D54022M15	2 x 2 x 1,5	10,5	86,4	140	16

Other dimension and colours available on request.

GAALFLEX® DATA Li2YCY (TP) Pimf

paired PE/PVC data cable with double screened, 300 V

ELETTROTEK KABEL® GAALFLEX® DATA Li2YCY TP Pimf

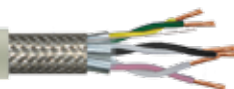

Construction:

Conductor:	flexible red copper conductor Cl.5, acc.to IEC 60228, DIN VDE 0295
Insulation:	PE compound
Colour cores:	acc. to DIN 47100
Stranding:	cores twisted in pairs, pairs twisted in layers
Individual screen:	pairs screened individually with aluminium tape + tinned copper drain wire
Wrapping:	PETP foil
Screen:	tinned copper braid
Outer sheath:	grey, (RAL 7032) PVC type TM2 acc. to DIN VDE 0281 part 1

Resistance:



Self-extinguishing and flame retardant acc. to:
DIN VDE 0482 part 265-2-1
EN 50265-2-1
IEC 60332-1-2

Technical data:

Nominal voltage:	max. 300 V
Test voltage:	
<i>Core/core:</i>	2 kV
<i>Core/screen:</i>	1 kV
Temperature range	
<i>Fixed laying:</i>	- 20°C up to +80°C
<i>Flexible installation:</i>	- 5°C up to + 80°C
Min. bending radius	
<i>Fixed laying:</i>	6 x d
<i>Flexible installation:</i>	10 x d
Radiation resistance:	80 x 10 ⁶ cJ/kg
Insulation resistance:	5 GOhm x km
Mutual capacitance	
<i>Core/core:</i>	75 _p f/m
Impedence	
<i>at 1 kHz:</i>	360 Ohm
<i>at 10 kHz:</i>	125 Ohm
<i>at 100 kHz:</i>	87 Ohm
<i>at 1000 kHz:</i>	70 Ohm
Line attenuation	
<i>at 1 kHz:</i>	1,1 dB
<i>at 10 kHz:</i>	2,7 dB
<i>at 100 kHz:</i>	6,8 dB
<i>at 1000 kHz:</i>	1000 dB
Cross talk attenuation:	min. 60 dB at 100 kHz

Features:

- On request tinned copper conductor
- Good EMC characteristics
- Flexible
- small outer diameter
- small bending radius
- RoHS and CE approval



Applications:

This cable type offers total interference-free data transfer and is ideal for use as a signal and control cable in combination with computers and external units

DATA CABLES

GAALFLEX® DATA Li2YCY (TP) Pimf

paired PE/PVC data cable with double screened, 300V

ELETTROTEK KABEL® GAALFLEX® DATA Li2YCY TP Pimf

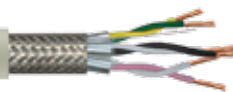

Part no.	No. of cores x cross section n x mm ²	Outer-Ø ca. mm ± 10%	Copper weight kg/km	Cable weight approx. kg/km	AWG no. *)
35110C64022M05	2 x 2 x 0,50	9,1	50	101	20
35110C64032M05	3 x 2 x 0,50	10	66	120	20
35110C64042M05	4 x 2 x 0,50	12	108	196	20
35110C64052M05	5 x 2 x 0,50	13,1	120	201	20
35110C64062M05	6 x 2 x 0,50	14,4	148	260	20
35110C64082M05	8 x 2 x 0,50	15	180	310	20
35110C64102M05	10 x 2 x 0,50	17,6	236	398	20
35110C64162M05	16 x 2 x 0,50	21,2	338	515	20
35110C64202M05	20 x 2 x 0,50	22,9	394	688	20
35110C64302M05	30 x 2 x 0,50	27,9	577	980	20
35110C64402M05	40 x 2 x 0,50	38,3	684	1390	20
35110C64502M05	50 x 2 x 0,50	43,2	834	1860	20
35110C64022M07	2 x 2 x 0,75	10,4	61	117	19
35110C64032M07	3 x 2 x 0,75	11,3	97	142	19
35110C64042M07	4 x 2 x 0,75	14	141	240	19
35110C64052M07	5 x 2 x 0,75	15,1	163	304	19
35110C64062M07	6 x 2 x 0,75	16,8	198	352	19
35110C64082M07	8 x 2 x 0,75	17,2	246	415	19
35110C64102M07	10 x 2 x 0,75	19,8	305	5,5	19
35110C64162M07	16 x 2 x 0,75	24	446	732	19
35110C64202M07	20 x 2 x 0,75	25,6	530	860	19
35110C64302M07	30 x 2 x 0,75	30,9	765	1210	19
35110C64022M10	2 x 2 x 1	11,9	72	130	18
35110C64032M10	3 x 2 x 1	12,2	104	161	18
35110C64042M10	4 x 2 x 1	16,2	186	360	18
35110C64052M10	5 x 2 x 1	17,4	231	412	18
35110C64062M10	6 x 2 x 1	18,7	260	472	18
35110C64082M10	8 x 2 x 1	19,2	322	540	18
35110C64102M10	10 x 2 x 1	22,2	382	670	18
35110C64162M10	16 x 2 x 1	26,9	578	982	18
35110C64202M10	20 x 2 x 1	29,4	810	1240	18
35110C64302M10	30 x 2 x 1	35,4	1050	1720	18
35110C64022M15	2 x 2 x 1,5	12,8	81	164	16
35110C64032M15	3 x 2 x 1,5	14,1	141	197	16
35110C64042M15	4 x 2 x 1,5	17,4	261	480	16
35110C64052M15	5 x 2 x 1,5	18,4	284	516	16
35110C64062M15	6 x 2 x 1,5	20,1	355	590	16
35110C64082M15	8 x 2 x 1,5	20,7	448	696	16
35110C64102M15	10 x 2 x 1,5	23,9	551	874	16
35110C64162M15	16 x 2 x 1,5	29,7	838	1340	16
35110C64202M15	20 x 2 x 1,5	31,7	1030	1620	16

Other dimension and colours available on request.

GAALFLEX® DATA LIYY UL

PVC data cable, 300 V UL/CSA



ELETTROTEK KABEL® GAALFLEX® DATA LIYY UL



Construction:

Conductor:	flexible red copper conductor acc. to ASTM B 286
Insulation:	PVC semi-rigid compound
Colour cores:	acc. to US 2
Stranding:	in layers
Outer sheath:	grey, (RAL 7032), PVC type YM1, acc. to DIN VDE 0207 part. 5

Resistance:



Self-extinguishing and flame retardant acc. to:

DIN VDE 0482 part 265-2-1
EN 50265-2-1
IEC 60332-1-2,
CSA FT1 FT2



Oil resistance acc. to:

DIN VDE 0473 part 811-2-1
IEC EN 60811-2-1

Technical data:

Nominal voltage:	300 V
Test voltage:	1,5 kV
Temperature range	DIN VDE: UL/CSA: up to + 80°C
<i>Fixed laying:</i>	- 30°C up to +70°C
<i>Flexible installation:</i>	- 5°C up to + 70°C
Min. bending radius	
<i>Fixed laying:</i>	5 x d
<i>Flexible installation:</i>	10 x d

Features:

on request color cores acc. to DIN 47100

 AWM style 2464 80°C 300 V CSA AWM I/II A/B 80°C 300 V FT1 FT2 CE

flexible

small outer diameter

small bending radius

RoHS and CE approval



DATA CABLES

GAALFLEX® DATA LIYY UL

PVC data cable, 300 V UL/CSA



ELETTROTEK KABEL® GAALFLEX® DATA LIYY UL



Part no.	No. of cores x cross section n x mm ²	Outer-Ø ca. mm ± 10%	Copper weight kg/km	Cable weight approx. kg/km	AWG no. *)
35070C66020A26	2 x 0,14	3,6	2,7	16	26
35070C66030A26	3 x 0,14	3,8	4	19	26
35070C66040A26	4 x 0,14	4	5,4	21	26
35070C66050A26	5 x 0,14	4,3	6,7	25	26
35070C66070A26	7 x 0,14	4,7	9,4	30	26
35070C66080A26	8 x 0,14	5,2	10,8	36	26
35070C66120A26	12 x 0,14	5,7	16,1	45	26
35070C66160A26	16 x 0,14	6,3	21,5	56	26
35070C66180A26	18 x 0,14	6,6	24,2	61	26
35070C66250A26	25 x 0,14	7,8	33,6	80	26
35070C66020A24	2 x 0,25	3,9	4,4	20	24
35070C66030A24	3 x 0,25	4,1	6,6	23	24
35070C66040A24	4 x 0,25	4,3	8,8	27	24
35070C66050A24	5 x 0,25	4,7	11	32	24
35070C66070A24	7 x 0,25	5	15,5	39	24
35070C66080A24	8 x 0,25	5,7	17,7	45	24
35070C66120A24	12 x 0,25	6,3	26,5	59	24
35070C66160A24	16 x 0,25	6,9	35,3	74	24
35070C66180A24	18 x 0,25	7,2	39,7	82	24
35070C66250A24	25 x 0,25	8,5	55,2	107	24
35070C66020A22	2 x 0,34	4,2	6	24	22
35070C66030A22	3 x 0,34	4,4	10,4	29	22
35070C66040A22	4 x 0,34	4,7	13,8	34	22
35070C66050A22	5 x 0,34	5,1	17,3	41	22
35070C66070A22	7 x 0,34	5,5	24,2	51	22
35070C66080A22	8 x 0,34	6,2	27,6	60	22
35070C66120A22	12 x 0,34	6,9	41,5	78	22
35070C66160A22	16 x 0,34	7,6	55,3	100	22
35070C66180A22	18 x 0,34	8	62,2	110	22
35070C66250A22	25 x 0,34	9,4	86,4	146	22
35070C66020A20	2 x 0,5	4,7	11,9	33	20
35070C66030A20	3 x 0,5	4,9	17,9	40	20
35070C66040A20	4 x 0,5	5,3	23,8	48	20
35070C66050A20	5 x 0,5	5,7	29,8	57	20
35070C66070A20	7 x 0,5	6,2	41,7	73	20
35070C66120A20	12 x 0,5	7,9	71,4	115	20
35070C66180A20	18 x 0,5	9,2	107,1	164	20
35070C66250A20	25 x 0,5	12,4	148,8	228	20
35070C66020A18	2 x 1	5,2	18,4	43	18
35070C66030A18	3 x 1	5,4	27,6	53	18
35070C66040A18	4 x 1	5,9	36,9	66	18
35070C66050A18	5 x 1	6,4	46,1	79	18
35070C66070A18	7 x 1	6,9	64,5	102	18
35070C66120A18	12 x 1	8,9	110,6	164	18
35070C66180A18	18 x 1	10,6	165,9	238	18
35070C66250A18	25 x 1	13,1	230,4	321	18
35070C66020A16	2 x 1,5	5,5	23,6	51	16
35070C66030A16	3 x 1,5	5,8	35,4	64	16
35070C66040A16	4 x 1,5	6,2	47,2	78	16
35070C66050A16	5 x 1,5	6,8	59	92	16
35070C66070A16	7 x 1,5	7,4	82,7	123	16

Other dimension and colours available on request.



GAALFLEX® DATA LIYCY UL

PVC data cable with overall copper screen, 300 V UL/CSA

ELETTROTEK KABEL® GAALFLEX® DATA LIYCY UL



Construction:

Conductor:	flexible red copper conductor acc. to ASTM B 286
Insulation:	PVC semi-rigid compound
Colour cores:	acc. to US 2
Stranding:	in layers
Wrapping:	PETP foil
Screen:	tinned copper braid
Outer sheath:	grey, (RAL 7032), PVC type YM1, acc. to DIN VDE 0207 part. 5

Resistance:



Self-extinguishing and flame retardant acc. to:
 DIN VDE 0482 part 265-2-1
 EN 50265-2-1
 IEC 60332-1-2,
 CSA FT1 FT2



Oil resistance acc. to:
 DIN VDE 0473 part 811-2-1
 IEC EN 60811-2-1

Technical data:

Nominal voltage:	300 V
Test voltage:	1,5 kV
Temperature range	DIN VDE: UL/CSA: up to + 80°C
<i>Fixed laying:</i>	- 30°C up to +70°C
<i>Flexible installation:</i>	- 5°C up to + 70°C
Min. bending radius	
<i>Fixed laying:</i>	5 x d
<i>Flexible installation:</i>	10 x d

Features:

on request color cores acc. to DIN 47100

AWM style 2464 80°C 300 V CSA AWM I/II A/B 80°C 300 V FT1 FT2 CE

flexible

small outer diameter

small bending radius

good EMC characteristics

RoHS and CE approval



DATA CABLES

GAALFLEX® DATA LiYCY UL

PVC data cable with overall copper screen, 300V UL/CSA



ELETTROTEK KABEL® GAALFLEX® DATA LiYCY UL



Part no.	No. of cores x cross section n x mm ²	Outer-Ø ca. mm ± 10%	Copper weight kg/km	Cable weight approx. kg/km	AWG no. *)
35080C66020A26	2 x 0,14	4,1	9,5	22	26
35080C66030A26	3 x 0,14	4,3	10,8	24	26
35080C66040A26	4 x 0,14	4,5	12,2	26	26
35080C66050A26	5 x 0,14	4,8	15,3	31	26
35080C66070A26	7 x 0,14	5,1	18	36	26
35080C66080A26	8 x 0,14	5,7	21,2	44	26
35080C66120A26	12 x 0,14	6,2	26,6	52	26
35080C66160A26	16 x 0,14	6,8	33,9	64	26
35080C66180A26	18 x 0,14	7,1	38,4	71	26
35080C66250A26	25 x 0,14	8,2	50	91	26
35080C66020A24	2 x 0,25	4,4	11,2	25	24
35080C66030A24	3 x 0,25	4,6	13,4	28	24
35080C66040A24	4 x 0,25	4,9	17,4	33	24
35080C66050A24	5 x 0,25	5,2	19,6	38	24
35080C66070A24	7 x 0,25	5,5	25,8	46	24
35080C66080A24	8 x 0,25	6,2	28,2	55	24
35080C66100A24	10 x 0,25	6,6	34,4	60	24
35080C66120A24	12 x 0,25	6,8	38,9	67	24
35080C66160A24	16 x 0,25	7,4	49,7	84	24
35080C66180A24	18 x 0,25	7,8	54,2	92	24
35080C66250A24	25 x 0,25	9,2	73,8	123	24
35080C66020A22	2 x 0,34	4,7	13,7	28	22
35080C66030A22	3 x 0,34	4,9	18,9	34	22
35080C66040A22	4 x 0,34	5,2	22,4	40	22
35080C66050A22	5 x 0,34	5,6	27,7	47	22
35080C66070A22	7 x 0,34	6	34,6	57	22
35080C66080A22	8 x 0,34	6,7	40	68	22
35080C66100A22	10 x 0,34	7,2	48,8	78	22
35080C66120A22	12 x 0,34	7,4	55,8	87	22
35080C66160A22	16 x 0,34	8,1	71,7	107,4	22
35080C66180A22	18 x 0,34	8,7	78,8	117,4	22
35080C66250A22	25 x 0,34	10,1	107,4	147,4	22
35080C66020A20	2 x 0,5	5,2	20,5	37	20
35080C66030A20	3 x 0,5	5,4	26,5	44	20
35080C66040A20	4 x 0,5	5,8	34,2	54	20
35080C66050A20	5 x 0,5	6,2	40,3	63	20
35080C66060A20	6 x 0,5	6,7	48,1	74	20
35080C66070A20	7 x 0,5	6,7	54	80	20
35080C66100A20	10 x 0,5	8,2	76	109	20
35080C66120A20	12 x 0,5	8,5	87,9	127	20
35080C66180A20	18 x 0,5	9,9	126,1	179	20
35080C66250A20	25 x 0,5	11,6	172,8	238	20
35080C66020A18	2 x 1	5,6	28,8	47	18
35080C66030A18	3 x 1	5,9	38,1	57	18
35080C66040A18	4 x 1	6,3	49,1	71	18
35080C66050A18	5 x 1	6,9	60,3	86	18
35080C66070A18	7 x 1	7,4	78,8	108	18
35080C66080A18	8 x 1	8,6	90,2	131	18
35080C66120A18	12 x 1	9,6	129,4	176	18
35080C66180A18	18 x 1	11,1	189,5	251	18
35080C66250A18	25 x 1	13,4	258,9	346	18
35080C66020A16	2 x 1,5	6	34,1	54	16
35080C66030A16	3 x 1,5	6,2	45,9	67	16
35080C66040A16	4 x 1,5	6,7	59,6	83	16
35080C66050A16	5 x 1,5	7,3	73,3	101	16
35080C66070A16	7 x 1,5	7,9	99	130	16
35080C66080A16	8 x 1,5	9,1	113,1	157	16
35080C66120A16	12 x 1,5	10,2	162,8	212	16

Other dimension and colours available on request.

GAALFLEX® DATA LiYCY (B) TP UL

paired PVC data cable with drain wire, overall copper screen, 300V UL/CSA



ELETTROTEK KABEL® GAALFLEX® DATA LIYCY B TP UL



Construction:

Conductor:	flexible red copper conductor acc. to ASTM B 286
Insulation:	PVC semi-rigid compound
Colour cores:	acc. to US 3 (on request DIN 47100)
Stranding:	cores twisted to pairs, pairs stranded in layers
Wrapping:	PETP foil
Screen:	tinned copper braid + tinned copper drain wire
Outer sheath:	grey, (RAL 7032), PVC type YM1, acc. to DIN VDE 0207 part. 5

Resistance:



Self-extinguishing and flame retardant acc. to:
 DIN VDE 0482 part 265-2-1
 EN 50265-2-1
 IEC 60332-1-2,
 CSA FT1 FT2



Oil resistance acc. to:
 DIN VDE 0473 part 811-2-1
 IEC EN 60811-2-1

Technical data:

Nominal voltage:	300 V
Test voltage:	1,5 kV
Temperature range	DIN VDE: UL/CSA: up to + 80°C
<i>Fixed laying:</i>	- 30°C up to +70°C
<i>Flexible installation:</i>	- 5°C up to + 70°C
Min. bending radius	
<i>Fixed laying:</i>	5 x d
<i>Flexible installation:</i>	10 x d

Features:

 AWM style 2464 80°C 300 V CSA AWM I/II A/B 80°C
 300 V FT1 FT2 CE

flexible

small outer diameter

small bending radius

good EMC characteristics

RoHS and CE approval



DATA CABLES

GAALFLEX® DATA LiYCY (B) TP UL

paired PVC data cable with drain wire, overall copper screen, 300V UL/CSA



ELETTROTEK KABEL® GAALFLEX® DATA LiYCY B TP UL



Part no.	No. of cores x cross section n x mm ²	Outer-Ø ca. mm ± 10%	Copper weight kg/km	Cable weight approx. kg/km	AWG no. *)
35090C67022A26	2 x 2 x 0,14	5,5	14,9	34	26
35090C67032A26	3 x 2 x 0,14	6,1	19,2	43	26
35090C67042A26	4 x 2 x 0,14	6,8	23,5	49	26
35090C67052A26	5 x 2 x 0,14	7,3	26,3	56	26
35090C67062A26	6 x 2 x 0,14	7,6	33,3	66	26
35090C67082A26	8 x 2 x 0,14	8,1	36,1	72	26
35090C67102A26	10 x 2 x 0,14	9	43,3	89	26
35090C67122A26	12 x 2 x 0,14	9,8	50,6	102	26
35090C67162A26	16 x 2 x 0,14	10,6	63,4	125	26
35090C67182A26	18 x 2 x 0,14	10,9	70,6	136	26
35090C67252A26	25 x 2 x 0,14	12,7	90,3	182	26
35090C67262A26	26 x 2 x 0,14	12,6	92,9	185	26
35090C67022A24	2 x 2 x 0,25	5,9	19,9	42	24
35090C67032A24	3 x 2 x 0,25	6,6	24,4	51	24
35090C67042A24	4 x 2 x 0,25	7,4	30,5	59	24
35090C67052A24	5 x 2 x 0,25	7,9	36,6	69	24
35090C67072A24	7 x 2 x 0,25	8,5	47,2	87	24
35090C67082A24	8 x 2 x 0,25	9	51,7	95	24
35090C67102A24	10 x 2 x 0,25	9,8	62,5	113	24
35090C67122A24	12 x 2 x 0,25	10,7	73,4	130	24
35090C67162A24	16 x 2 x 0,25	11,6	93,3	161	24
35090C67182A24	18 x 2 x 0,25	12,4	102,4	189	24
35090C67252A24	25 x 2 x 0,25	14	137,3	239	24
35090C67262A24	26 x 2 x 0,25	14,3	141,9	247	24
35090C67022A22	2 x 2 x 0,34	6,4	25	50	22
35090C67032A22	3 x 2 x 0,34	7,1	33,5	62	22
35090C67042A22	4 x 2 x 0,34	8	42,2	74	22
35090C67052A22	5 x 2 x 0,34	8,8	50,9	91	22
35090C67072A22	7 x 2 x 0,34	9,3	64,9	110	22
35090C67122A22	12 x 2 x 0,34	11,8	105,7	170	22
35090C67182A22	18 x 2 x 0,34	13,7	151,2	246	22
35090C67252A22	25 x 2 x 0,34	15,8	203	332	22
35090C67022A20	2 x 2 x 0,5	7	36,6	64	20
35090C67032A20	3 x 2 x 0,5	7,6	50,3	80	20
35090C67042A20	4 x 2 x 0,5	9,2	64,1	104	20
35090C67052A20	5 x 2 x 0,5	9,9	77,9	124	20
35090C67072A20	7 x 2 x 0,5	10,4	103,6	155	20
35090C67122A20	12 x 2 x 0,5	13,9	169,7	255	20
35090C67182A20	18 x 2 x 0,5	16	244,6	368	20
35090C67252A20	25 x 2 x 0,5	18,1	336,9	484	20
35090C67022A18	2 x 2 x 1	7,8	51,4	81	18
35090C67032A18	3 x 2 x 1	9	71,7	114	18
35090C67042A18	4 x 2 x 1	10,2	92,3	138	18
35090C67052A18	5 x 2 x 1	11,1	112,8	166	18
35090C67072A18	7 x 2 x 1	11,7	151,7	211	18
35090C67122A18	12 x 2 x 1	16	251,6	365	18
35090C67182A18	18 x 2 x 1	18	366,1	511	18
35090C67252A18	25 x 2 x 1	20,6	521,4	692	18
35090C67022A16	2 x 2 x 1,5	8,2	61,9	96	16
35090C67032A16	3 x 2 x 1,5	9,6	89,1	133	16
35090C67042A16	4 x 2 x 1,5	10,9	115	164	16
35090C67052A16	5 x 2 x 1,5	11,8	140,8	198	16
35090C67072A16	7 x 2 x 1,5	12,9	188,5	264	16
35090C67082A16	8 x 2 x 1,5	13,8	215,8	297	16

Other dimension and colours available on request.

GAALFLEX® DATA LIHH

Halogen-free data cable



ELETTROTEK KABEL® GAALFLEX® DATA LIHH



Construction:

Conductor:	flexible red copper conductor Cl. 5, acc to IEC 60228, DIN VDE 0295
Insulation:	halogen-free compound
Colour cores:	acc. to DIN 47100
Stranding:	in layers
Outer sheath:	grey (RAL 7001), halogen-free compound

Resistance:



Self-extinguishing and flame retardant acc. to:
DIN VDE 0482 part 265-2-1
EN 50265-2-1
IEC 60332-1-2



Oil resistance acc. to:
DIN VDE 0473 part 811-2-1
IEC EN 60811-2-1



Halogen-free acc. to:
acc. to DIN VDE 0482, part 267
EN 50267-2-1
IEC 60754-1



Low smoke density acc. to:
DIN VDE 0482 part. 268-1-2
IEC 61034-1-2

Technical data:

Nominal voltage:	< 0,34 mm ² = 250 V max.350 V ≥ 0,34 mm ² = 300/500 V
Test voltage:	< 0,34 mm ² = max. 800 V ≥ 0,34 mm ² = max. 1,2 kV
Temperature range	
<i>Fixed laying:</i>	- 40°C up to +70°C
<i>Flexible installation:</i>	- 15°C up to + 70°C
Min. bending radius	
<i>Fixed laying:</i>	5 x d
<i>Flexible installation:</i>	10 x d
Radiation resistance:	8 x 10 ⁷ cj/kg

Features:

- on request tinned copper conductor
- on request grey (RAL 7032)
- flexible
- small outer diameter
- small bending radius
- halogen-free
- RoHS and CE approva



Part no.	No. of cores x cross section n x mm ²	Outer-Ø ca.mm ± 10%	Copper weight kg/km	Cable weight approx. kg/km	AWG no. *)
35040C54020M01	2 x 0,14	3,1	2,7	13	26
35040C54030M01	3 x 0,14	3,3	4	15	26
35040C54040M01	4 x 0,14	3,5	5,4	17	26
35040C54050M01	5 x 0,14	3,8	6,7	21	26
35040C54060M01	6 x 0,14	4,1	8,1	25	26
35040C54070M01	7 x 0,14	4,1	9,4	25	26
35040C54080M01	8 x 0,14	4,7	10,8	33	26
35040C54100M01	10 x 0,14	5,1	13,4	34	26
35040C54120M01	12 x 0,14	5,3	16,1	39	26
35040C54140M01	14 x 0,14	5,5	18,8	44	26
35040C54160M01	16 x 0,14	6	21,5	53	26
35040C54180M01	18 x 0,14	6,3	24,2	59	26
35040C54200M01	20 x 0,14	6,6	26,9	65	26
35040C54210M01	21 x 0,14	6,9	28,2	69	26
35040C54240M01	24 x 0,14	7,3	32,3	73	26
35040C54250M01	25 x 0,14	7,7	33,6	79	26
35040C54270M01	27 x 0,14	7,7	36,3	83	26
35040C54300M01	30 x 0,14	7,9	40,3	90	26
35040C54320M01	32 x 0,14	8,2	43	97	26
35040C54360M01	36 x 0,14	8,5	48,4	107	26

DATA CABLES

GAALFLEX® DATA LIHH

Halogen-free data cable



ELETTROTEK KABEL® GAALFLEX® DATA LIHH



Part no.	No.of cores x cross section n x mm ²	Outer-Ø ca.mm ± 10%	Copper weight kg/km	Cable weight approx. kg/km	AWG no.*)
35040C54400M01	40 x 0,14	9,1	53,8	119	26
35040C54440M01	44 x 0,14	9,5	59,1	126	26
35040C54480M01	48 x 0,14	10,1	64,5	144	26
35040C54500M01	50 x 0,14	10,3	67,2	149	26
35040C54520M01	52 x 0,14	10,3	69,9	154	26
35040C54560M01	56 x 0,14	10,6	75,3	165	26
35040C54610M01	61 x 0,14	10,9	82	175	26
35040C54020M02	2 x 0,25	3,4	4,8	16	24
35040C54030M02	3 x 0,25	3,6	7,2	20	24
35040C54040M02	4 x 0,25	3,9	9,6	24	24
35040C54050M02	5 x 0,25	4,2	12,	29	24
35040C54060M02	6 x 0,25	4,6	14,4	34	24
35040C54070M02	7 x 0,25	4,6	16,8	35	24
35040C54080M02	8 x 0,25	5,2	19,2	45	24
35040C54090M02	9 x 0,25	5,6	21,6	51	24
35040C54100M02	10 x 0,25	5,9	24	51	24
35040C54120M02	12 x 0,25	6,1	28,8	58	24
35040C54140M02	14 x 0,25	6,4	33,6	66	24
35040C54160M02	16 x 0,25	6,7	38,4	74	24
35040C54180M02	18 x 0,25	7,1	43,2	83	24
35040C54200M02	20 x 0,25	7,6	48,0	95	24
35040C54210M02	21 x 0,25	7,9	50,4	100	24
35040C54240M02	24 x 0,25	8,4	57,6	108	24
35040C54250M02	25 x 0,25	8,6	60	112	24
35040C54270M02	27 x 0,25	8,6	64,8	119	24
35040C54300M02	30 x 0,25	8,9	72,0	131	24
35040C54320M02	32 x 0,25	9,2	76,8	139	24
35040C54360M02	36 x 0,25	10	86,4	163	24
35040C54400M02	40 x 0,25	10,6	96	181	24
35040C54440M02	44 x 0,25	11,1	105,6	192	24
35040C54480M02	48 x 0,25	11,3	115,2	206	24
35040C54500M02	50 x 0,25	11,6	120	214	24
35040C54520M02	52 x 0,25	11,6	124,8	221	24
35040C54560M02	56 x 0,25	11,9	134,4	237	24
35040C54610M02	61 x 0,25	12,3	146,4	254	24
35040D54020M03	2 x 0,34	4	6,5	23	22
35040D54030M03	3 x 0,34	4,2	9,8	27	22
35040D54040M03	4 x 0,34	4,6	13,1	33	22
35040D54050M03	5 x 0,34	5	16,3	41	22
35040D54060M03	6 x 0,34	5,5	19,6	49	22
35040D54070M03	7 x 0,34	5,5	22,8	51	22
35040D54080M03	8 x 0,34	6,5	26,1	67	22
35040D54100M03	10 x 0,34	7,1	32,6	72	22
35040D54120M03	12 x 0,34	7,3	39,2	83	22
35040D54140M03	14 x 0,34	7,9	45,7	98	22
35040D54160M03	16 x 0,34	8,3	52,2	111	22
35040D54180M03	18 x 0,34	8,8	58,8	124	22
35040D54200M03	20 x 0,34	9,2	65,3	137	22
35040D54210M03	21 x 0,34	10	68,5	153	22
35040D54240M03	24 x 0,34	10,6	78,3	165	22
35040D54250M03	25 x 0,34	10,8	81,6	170	22
35040D54270M03	27 x 0,34	10,8	88,1	181	22
35040D54300M03	30 x 0,34	11,2	97,9	197	22
35040D54320M03	32 x 0,34	11,6	104,4	210	22
35040D54360M03	36 x 0,34	12,1	117,5	234	22
35040D54400M03	40 x 0,34	12,9	130,6	261	22
35040D54440M03	44 x 0,34	13,5	143,6	277	22
35040D54480M03	48 x 0,34	13,7	156,7	298	22
35040D54520M03	52 x 0,34	14,5	169,7	333	22
35040D54560M03	56 x 0,34	14,9	182,8	356	22
35040D54610M03	61 x 0,34	15,4	199,1	382	22

DATA CABLES

GAALFLEX® DATA LIHH

Halogen-free data cable



ELETTROTEK KABEL® GAALFLEX® DATA LIHH



Part no.	No. of cores x cross section n x mm ²	Outer-Ø ca. mm ± 10%	Copper weight kg/km	Cable weight approx. kg/km	AWG no. *)
35040D54020M05	2 x 0,50	4,3	9,6	27	20
35040D54030M05	3 x 0,50	4,5	14,4	33	20
35040D54040M05	4 x 0,50	4,9	19,2	40	20
35040D54050M05	5 x 0,50	5,4	24	50	20
35040D54060M05	6 x 0,50	6,1	28,8	62	20
35040D54070M05	7 x 0,50	6,1	33,6	65	20
35040D54080M05	8 x 0,50	7,1	38,4	83	20
35040D54100M05	10 x 0,50	7,9	48	92	20
35040D54120M05	12 x 0,50	8,1	57,6	106	20
35040D54140M05	14 x 0,50	8,5	67,2	120	20
35040D54160M05	16 x 0,50	9	76,8	137	20
35040D54180M05	18 x 0,50	9,5	86,4	152	20
35040D54200M05	20 x 0,50	10,4	96	178	20
35040D54210M05	21 x 0,50	10,9	100,8	189	20
35040D54240M05	24 x 0,50	11,5	115,2	203	20
35040D54250M05	25 x 0,50	11,7	120	210	20
35040D54270M05	27 x 0,50	11,7	129,6	223	20
35040D54300M05	30 x 0,50	12,1	144	244	20
35040D54320M05	32 x 0,50	12,6	153,6	261	20
35040D54360M05	36 x 0,50	13,1	172,8	290	20
35040D54400M05	40 x 0,50	14,5	192	337	20
35040D54440M05	44 x 0,50	15,1	211,2	358	20
35040D54480M05	48 x 0,50	15,3	230,4	384	20
35040D54520M05	52 x 0,50	15,7	249,6	412	20
35040D54560M05	56 x 0,50	16,2	268,8	442	20
35040D54610M05	61 x 0,50	16,7	292,8	475	20
35040D54020M07	2 x 0,75	4,9	14,4	37	19
35040D54030M07	3 x 0,75	5,2	21,6	45	19
35040D54040M07	4 x 0,75	5,9	28,8	58	19
35040D54050M07	5 x 0,75	6,4	36	71	19
35040D54060M07	6 x 0,75	7	43,2	84	19
35040D54070M07	7 x 0,75	7	50,4	89	19
35040D54080M07	8 x 0,75	8,3	57,6	116	19
35040D54100M07	10 x 0,75	9,1	72	127	19
35040D54120M07	12 x 0,75	9,4	86,4	146	19
35040D54140M07	14 x 0,75	10,3	100,8	175	19
35040D54160M07	16 x 0,75	10,8	115,2	198	19
35040D54180M07	18 x 0,75	11,4	129,6	221	19
35040D54210M07	21 x 0,75	12,5	151,2	260	19
35040D54240M07	24 x 0,75	13,3	172,8	280	19
35040D54270M07	27 x 0,75	13,6	194,4	309	19
35040D54300M07	30 x 0,75	14,5	216	351	19
35040D54320M07	32 x 0,75	15	230,4	375	19
35040D54360M07	36 x 0,75	15,6	259,2	417	19
35040D54020M10	2 x 1	5,1	19,2	43	18
35040D54030M10	3 x 1	5,4	28,8	54	18
35040D54040M10	4 x 1	6,1	38,4	70	18
35040D54050M10	5 x 1	6,7	48	87	18
35040D54060M10	6 x 1	7,3	57,6	103	18
35040D54070M10	7 x 1	7,3	67,2	110	18
35040D54020M15	2 x 1,5	5,6	28,8	54	16
35040D54030M15	3 x 1,5	6,1	43,2	70	16
35040D54040M15	4 x 1,5	6,7	57,6	87	16
35040D54050M15	5 x 1,5	7,7	72	115	16
35040D54060M15	6 x 1,5	8,4	86,4	136	16
35040D54070M15	7 x 1,5	8,4	100,8	146	16

Other dimension and colours available on request.

GAALFLEX® DATA LIHCH

halogen-free data cable with overall copper screen



ELETTROTEK KABEL® GAALFLEX® DATA LIHCH



Construction:

Conductor:	flexible red copper conductor Cl. 5, acc to IEC 60228, DIN VDE 0295
Insulation:	halogen-free compound
Colour cores:	acc. to DIN 47100
Stranding:	in layers
Wrapping:	PETP foi
Screen:	tinned copper braid
Outer sheath:	grey (RAL 7001), halogen-free compound

Resistance:



Self-extinguishing and flame retardant acc. to:
DIN VDE 0482 part 265-2-1
EN 50265-2-1
IEC 60332-1-2



Oil resistance acc. to:
DIN VDE 0473 part 811-2-1
IEC EN 60811-2-1



Halogen-free acc. to:
acc. to DIN VDE 0482, part 267
EN 50267-2-1
IEC 60754-1



Low smoke density acc. to:
DIN VDE 0482 part. 268-1-2
IEC 61034-1-2

Technical data:

Nominal voltage:	< 0,34 mm ² = 250 V max.350 V ≥ 0,34 mm ² = 300/500 V
Test voltage:	< 0,34 mm ² = max. 800 V ≥ 0,34 mm ² = max. 1,2 kV
Temperature range	
<i>Fixed laying:</i>	- 40°C up to +70°C
<i>Flexible installation:</i>	- 15°C up to + 70°C
Min. bending radius	
<i>Fixed laying:</i>	5 x d
<i>Flexible installation:</i>	10 x d
Radiation resistance:	8 x 10 ⁷ cj/kg

Features:

- on request tinned copper conductor
- on request grey (RAL 7032)
- flexible
- small outer diameter
- small bending radius
- halogen-free
- RoHS and CE approva



Part no.	No.of cores x cross section n x mm ²	Outer-Ø ca.mm ± 10%	Copper weight kg/km	Cable weight approx. kg/km	AWG no.*)
35050C54020M01	2 x 0,14	3,6	12,6	18	26
35050C54030M01	3 x 0,14	3,8	14,1	21	26
35050C54040M01	4 x 0,14	4	15,9	24	26
35050C54050M01	5 x 0,14	4,3	19,5	29	26
35050C54060M01	6 x 0,14	4,6	22	33	26
35050C54070M01	7 x 0,14	4,6	24	33	26
35050C54080M01	8 x 0,14	5,4	26	44	26
35050C54100M01	10 x 0,14	5,8	29	47	26
35050C54120M01	12 x 0,14	6,2	32	55	26
35050C54140M01	14 x 0,14	6,4	35	61	26
35050C54160M01	16 x 0,14	6,7	49	69	26
35050C54180M01	18 x 0,14	7	54	75	26
35050C54200M01	20 x 0,14	7,3	58	82	26
35050C54210M01	21 x 0,14	7,6	60	87	26
35050C54240M01	24 x 0,14	8	74	92	26
35050C54250M01	25 x 0,14	8,6	78	102	26
35050C54270M01	27 x 0,14	8,6	85	106	26
35050C54300M01	30 x 0,14	8,8	98	116	26
35050C54320M01	32 x 0,14	9,1	108	122	26
35050C54360M01	36 x 0,14	9,4	117	133	26

DATA CABLES

GAALFLEX® DATA LIHCH

halogen-free data cable with overall copper screen



ELETTROTEK KABEL® GAALFLEX® DATA LIHCH



Part no.	No. of cores x cross section n x mm ²	Outer-Ø ca. mm ± 10%	Copper weight kg/km	Cable weight approx. kg/km	AWG no. *)
35050C54400M01	40 x 0,14	10	126	148	26
35050C54440M01	44 x 0,14	10,6	138	168	26
35050C54480M01	48 x 0,14	10,8	145	177	26
35050C54500M01	50 x 0,14	11	150	183	26
35050C54520M01	52 x 0,14	11	155	187	26
35050C54560M01	56 x 0,14	11,3	166	202	26
35050C54610M01	61 x 0,14	11,6	176	213	26
35050C54010M02	1 x 0,25	2,7	8	13	24
35050C54020M02	2 x 0,25	3,9	15	23	24
35050C54030M02	3 x 0,25	4,1	18	26	24
35050C54040M02	4 x 0,25	4,4	22	31	24
35050C54050M02	5 x 0,25	4,9	25	38	24
35050C54060M02	6 x 0,25	5,3	30	45	24
35050C54070M02	7 x 0,25	5,3	32	46	24
35050C54080M02	8 x 0,25	6,1	35	59	24
35050C54090M02	9 x 0,25	6,5	39	57	24
35050C54100M02	10 x 0,25	6,6	42	65	24
35050C54120M02	12 x 0,25	6,8	50	73	24
35050C54140M02	14 x 0,25	7,1	64	81	24
35050C54150M02	15 x 0,25	7,4	68	90	24
35050C54160M02	16 x 0,25	7,4	71	91	24
35050C54180M02	18 x 0,25	7,8	80	102	24
35050C54200M02	20 x 0,25	8,5	96	117	24
35050C54210M02	21 x 0,25	8,8	105	125	24
35050C54240M02	24 x 0,25	9,3	115	133	24
35050C54250M02	25 x 0,25	9,5	117	139	24
35050C54270M02	27 x 0,25	9,5	120	145	24
35050C54300M02	30 x 0,25	9,8	132	157	24
35050C54320M02	32 x 0,25	10,1	138	166	24
35050C54360M02	36 x 0,25	10,7	152	195	24
35050C54400M02	40 x 0,25	11,3	164	217	24
35050C54440M02	44 x 0,25	11,8	180	229	24
35050C54480M02	48 x 0,25	12,4	209	254	24
35050C54500M02	50 x 0,25	12,7	222	262	24
35050C54520M02	52 x 0,25	12,7	234	269	24
35050C54560M02	56 x 0,25	13	259	288	24
35050C54610M02	61 x 0,25	13,4	287	306	24
35050D54020M03	2 x 0,34	4,5	17	29	22
35050D54030M03	3 x 0,34	4,9	21	35	22
35050D54040M03	4 x 0,34	5,3	25	43	22
35050D54050M03	5 x 0,34	5,7	30	52	22
35050D54060M03	6 x 0,34	6,4	37	64	22
35050D54070M03	7 x 0,34	6,4	42	65	22
35050D54080M03	8 x 0,34	7,2	45	81	22
35050D54100M03	10 x 0,34	7,8	63	89	22
35050D54120M03	12 x 0,34	8,0	70	100	22
35050D54140M03	14 x 0,34	8,8	78	121	22
35050D54160M03	16 x 0,34	9,2	87	134	22
35050D54180M03	18 x 0,34	9,7	108	150	22
35050D54200M03	20 x 0,34	10,1	124	163	22
35050D54210M03	21 x 0,34	10,7	127	185	22
35050D54240M03	24 x 0,34	11,3	140	200	22
35050D54250M03	25 x 0,34	12,1	144	259	22
35050D54270M03	27 x 0,34	11,5	151	216	22
35050D54300M03	30 x 0,34	11,9	162	233	22
35050D54320M03	32 x 0,34	12,7	171	257	22
35050D54360M03	36 x 0,34	13,2	188	285	22
35050D54400M03	40 x 0,34	14	208	316	22
35050D54420M03	42 x 0,34	14	215	326	22
35050D54440M03	44 x 0,34	14,6	223	334	22
35050D54480M03	48 x 0,34	14,8	243	355	22
35050D54500M03	50 x 0,34	15,8	248	402	22
35050D54520M03	52 x 0,34	15,8	273	412	22
35050D54560M03	56 x 0,34	16,2	292	437	22
35050D54610M03	61 x 0,34	16,7	316	464	22

DATA CABLES

GAALFLEX® DATA LIHCH

halogen-free data cable with overall copper screen



ELETTROTEK KABEL® GAALFLEX® DATA LIHCH



Part no.	No. of cores x cross section n x mm ²	Outer-Ø ca. mm ± 10%	Copper weight kg/km	Cable weight approx. kg/km	AWG no. *)
35050D54010M05	1 x 0,5	3,2	13,3	19	20
35050D54020M05	2 x 0,5	5	23,5	36	20
35050D54030M05	3 x 0,5	5,2	28,4	42	20
35050D54040M05	4 x 0,5	5,6	35,1	51	20
35050D54050M05	5 x 0,5	6,3	41,6	64	20
35050D54060M05	6 x 0,5	6,8	48,3	75	20
35050D54070M05	7 x 0,5	6,8	53,1	78	20
35050D54080M05	8 x 0,5	7,8	62	99	20
35050D54100M05	10 x 0,5	8,8	74,5	115	20
35050D54120M05	12 x 0,5	9	84,2	128	20
35050D54140M05	14 x 0,5	9,4	93,5	143	20
35050D54160M05	16 x 0,5	9,9	105,9	162	20
35050D54180M05	18 x 0,5	10,6	133,9	191	20
35050D54200M05	20 x 0,5	11,1	143,8	208	20
35050D54210M05	21 x 0,5	11,6	154,9	224	20
35050D54240M05	24 x 0,5	12,6	169,7	248	20
35050D54250M05	25 x 0,5	12,8	174,6	256	20
35050D54270M05	27 x 0,5	12,8	184,2	269	20
35050D54300M05	30 x 0,5	13,2	203,6	293	20
35050D54320M05	32 x 0,5	13,7	213,5	311	20
35050D54360M05	36 x 0,5	14,2	239,0	344	20
35050D54400M05	40 x 0,5	15,8	289,4	416	20
35050D54420M05	42 x 0,5	15,8	299,0	429	20
35050D54500M05	50 x 0,5	17	349,7	487	20
35050D54520M05	52 x 0,5	17	359,3	500	20
35050D54610M05	61 x 0,5	18	403,7	565	20
35050D54010M07	1 x 0,75	3,5	15,7	22	19
35050D54020M07	2 x 0,75	5,6	30,3	45	19
35050D54030M07	3 x 0,75	6,1	37,6	56	19
35050D54040M07	4 x 0,75	6,6	46,5	68	19
35050D54050M07	5 x 0,75	7,1	55,7	83	19
35050D54060M07	6 x 0,75	7,7	66,8	99	19
35050D54070M07	7 x 0,75	7,7	74	103	19
35050D54080M07	8 x 0,75	9,2	83,8	136	19
35050D54100M07	10 x 0,75	10	101,1	150	19
35050D54120M07	12 x 0,75	10,5	133,9	183	19
35050D54140M07	14 x 0,75	11	148,5	203	19
35050D54160M07	16 x 0,75	11,5	169,2	231	19
35050D54180M07	18 x 0,75	12,4	184	264	19
35050D54210M07	21 x 0,75	13,6	211	307	19
35050D54240M07	24 x 0,75	14,4	239,1	333	19
35050D54270M07	27 x 0,75	14,7	260,9	363	19
35050D54300M07	30 x 0,75	15,8	313,4	428	19
35050D54320M07	32 x 0,75	16,3	328,3	453	19
35050D54360M07	36 x 0,75	16,9	357,8	496	19
35050D54010M10	1 x 1	3,5	18,2	25	18
35050D54020M10	2 x 1	5,8	35,2	50	18
35050D54030M10	3 x 1	6,3	46,4	64	18
35050D54040M10	4 x 1	6,8	57,9	79	18
35050D54050M10	5 x 1	7,4	69,6	96	18
35050D54060M10	6 x 1	8	81,3	113	18
35050D54070M10	7 x 1	8	90,9	120	18
35050D54010M15	1 x 1,5	3,8	24,7	31	16
35050D54020M15	2 x 1,5	6,5	46,5	68	16
35050D54030M15	3 x 1,5	6,8	62,7	79	16
35050D54040M15	4 x 1,5	7,4	79,2	98	16
35050D54050M15	5 x 1,5	8,6	95,8	131	16
35050D54060M15	6 x 1,5	9,3	112,7	155	16
35050D54070M15	7 x 1,5	9,3	127,1	164	16

Other dimension and colours available on request.

GAALFLEX® DATA LIHCH (B) TP

paired halogen-free data cable with drain wire, overall copper screen



ELETTROTEK KABEL® GAALFLEX® DATA LIHCH B TP

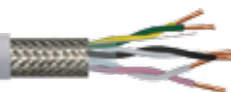

Construction:

Conductor:	flexible red copper conductor Cl. 5, acc to IEC 60228, DIN VDE 0295
Insulation:	halogen-free compound
Colour cores:	acc. to DIN 47100
Stranding:	cores twisted to pairs, pairs stranded in layers
Wrapping:	PETP foil
Screen:	tinned copper braid + tinned copper drain wire (0,34mm ²)
Outer sheath:	grey (RAL 7001), halogen-free compound

Resistance:



Self-extinguishing and flame retardant acc. to:
DIN VDE 0482 part 265-2-1
EN 50265-2-1
IEC 60332-1-2



Oil resistance acc. to:
DIN VDE 0473 part 811-2-1
IEC EN 60811-2-1



Halogen-free acc. to:
DIN VDE 0482, part 267
EN 50267-2-1
IEC 60754-1



Low smoke density acc. to:
DIN VDE 0482 part. 268-1-2
IEC 61034-1-2

Technical data:

Nominal voltage:	< 0,34 mm ² = 250 V max.350 V ≥ 0,34 mm ² = 300/500 V
Test voltage:	< 0,34 mm ² = max. 800 V ≥ 0,34 mm ² = max. 1,2 kV
Temperature range	
<i>Fixed laying:</i>	- 40°C up to +70°C
<i>Flexible installation:</i>	- 15°C up to + 70°C
Min. bending radius	
<i>Fixed laying:</i>	5 x d
<i>Flexible installation:</i>	10 x d
Radiation resistance:	8 x 10 ⁷ cj/kg

Features:

- on request tinned copper conductor
- on request grey (RAL 7032)
- good EMC characteristics
- flexible
- small outer diameter
- small bending radius
- halogen-free
- RoHS and CE approva



DATA CABLES

GAALFLEX® DATA LIHCH (B) TP

paired halogen-free data cable with drain wire, overall copper screen



ELETTROTEK KABEL® GAALFLEX® DATA LIHCH B TP

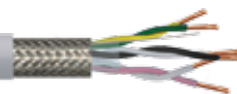

Part no.	No. of cores x cross section n x mm ²	Outer-Ø ca. mm ± 10%	Copper weight kg/km	Cable weight approx. kg/km	AWG no. *)
35060C54022M01	2 x 2 x 0,14	5,2	19,1	34	26
35060C54032M01	3 x 2 x 0,14	5,7	23,4	41	26
35060C54042M01	4 x 2 x 0,14	6,5	27,8	53	26
35060C54052M01	5 x 2 x 0,14	7	31,9	60	26
35060C54062M01	6 x 2 x 0,14	7,2	36,2	68	26
35060C54082M01	8 x 2 x 0,14	7,8	43,4	80	26
35060C54102M01	10 x 2 x 0,14	8,9	50,6	100	26
35060C54122M01	12 x 2 x 0,14	9,7	58,2	111	26
35060C54162M01	16 x 2 x 0,14	10,5	71,4	136	26
35060C54182M01	18 x 2 x 0,14	11,1	92,8	159	26
35060C54202M01	20 x 2 x 0,14	11,1	98,1	164	26
35060C54242M01	24 x 2 x 0,14	12,8	114,8	203	26
35060C54252M01	25 x 2 x 0,14	12,8	117,5	207	26
35060C54282M01	28 x 2 x 0,14	13,1	125,7	221	26
35060C54302M01	30 x 2 x 0,14	13,8	135,6	237	26
35060C54362M01	36 x 2 x 0,14	14,6	157,8	275	26
35060C54402M01	40 x 2 x 0,14	14,9	168,2	296	26
35060C54442M01	44 x 2 x 0,14	16,3	205,9	348	26
35060C54522M01	52 x 2 x 0,14	17	228,1	388	26
35060C54612M01	61 x 2 x 0,14	18,3	263,2	443	26
35060C54022M02	2 x 2 x 0,25	5,7	24,9	42	24
35060C54032M02	3 x 2 x 0,25	6,4	31,4	55	24
35060C54042M02	4 x 2 x 0,25	7,8	44,9	81	24
35060C54062M02	6 x 2 x 0,25	7,9	50,7	85	24
35060C54082M02	8 x 2 x 0,25	9	62,1	109	24
35060C54102M02	10 x 2 x 0,25	9,8	73,9	132	24
35060C54122M02	12 x 2 x 0,25	10,9	101,9	160	24
35060C54162M02	16 x 2 x 0,25	11,9	126,8	195	24
35060C54182M02	18 x 2 x 0,25	12,7	136,6	222	24
35060C54242M02	24 x 2 x 0,25	14,2	170,3	270	24
35060C54022M02	2 x 2 x 0,25	5,7	24,9	42	24
35060C54032M02	3 x 2 x 0,25	6,4	31,4	55	24
35060C54042M02	4 x 2 x 0,25	7,8	44,9	81	24
35060C54062M02	6 x 2 x 0,25	7,9	50,7	85	24
35060C54082M02	8 x 2 x 0,25	9	62,1	109	24
35060C54102M02	10 x 2 x 0,25	9,8	73,9	132	24
35060C54122M02	12 x 2 x 0,25	10,9	101,9	160	24
35060C54162M02	16 x 2 x 0,25	11,9	126,8	195	24
35060C54182M02	18 x 2 x 0,25	12,7	136,6	222	24
35060C54242M02	24 x 2 x 0,25	14,2	170,3	270	24
35060D54022M05	2 x 2 x 0,5	7,2	39,3	66	20
35060D54032M05	3 x 2 x 0,5	7,9	50,1	84	20
35060D54042M05	4 x 2 x 0,5	9,6	82	126	20
35060D54062M05	6 x 2 x 0,5	10,4	86	146	20
35060D54082M05	8 x 2 x 0,5	10,9	111,5	166	20
35060D54102M05	10 x 2 x 0,5	13,2	146,5	229	20
35060D54122M05	12 x 2 x 0,5	14,4	175,7	268	20
35060D54162M05	16 x 2 x 0,5	16,3	241,3	368	20
35060D54182M05	18 x 2 x 0,5	16,9	261	399	20
35060D54202M05	20 x 2 x 0,5	16,9	280,2	418	20
35060D54242M05	24 x 2 x 0,5	19	330,4	491	20
35060D54022M07	2 x 2 x 0,75	8,5	52,4	92	19
35060D54032M07	3 x 2 x 0,75	9,4	69,4	112	19
35060D54042M07	4 x 2 x 0,75	10,9	108,0	179	19
35060D54062M07	6 x 2 x 0,75	12,5	136,5	218	19
35060D54082M07	8 x 2 x 0,75	14,9	180	305	19
35060D54122M05	12 x 2 x 0,75	17,1	261,2	385	19
35060D54162M05	16 x 2 x 0,75	18,6	329,9	482	19
35060D54182M05	18 x 2 x 0,75	19,3	369,3	535	19
35060D54202M05	24 x 2 x 0,75	21,8	469,2	661	19
35060D54022M10	2 x 2 x 1	10,5	84	142	18
35060D54032M10	3 x 2 x 1	10,6	96	173	18
35060D54042M10	4 x 2 x 1	11,5	121	212	18
35060D54052M10	5 x 2 x 1	12,0	161	266	18

Other dimension and colours available on request.

DATA CABLES

GAALFLEX® DATA 300 CP

PUR data cable with overall copper screen

ELETTROTEK KABEL® GAALFLEX® DATA 300 CP



Construction:

Conductor:	flexible red copper conductor Cl. 5, acc to IEC 60228, DIN VDE 0295
Insulation:	PVC type Tl2 acc. to DIN VDE 0281 part 1
Colour cores:	acc. to DIN 47100
Stranding:	in layers
Wrapping:	PETP foil
Screen:	tinned copper braid
Outer sheath:	grey (RAL 7032), PUR compound

Resistance:



Self-extinguishing and flame retardant acc. to:
DIN VDE 0482 part 265-2-1
EN 50265-2-1
IEC 60332-1-2



Oil resistance acc. to:
DIN VDE 0473 part 811-2-1
IEC EN 60811-2-1

Technical data:

Nominal voltage:	$\leq 0,14 \text{ mm}^2 = \text{max. } 350 \text{ V}$ $\geq 0,25 \text{ mm}^2 = \text{max. } 500 \text{ V}$
Test voltage:	$\leq 0,14 \text{ mm}^2 = \text{max. } 800 \text{ V}$ $\geq 0,25 \text{ mm}^2 = \text{max. } 1,2 \text{ kV}$
Temperature range	
<i>Fixed laying:</i>	-40°C up to +80°C
<i>Flexible installation:</i>	-5°C up to +80°C
Min. bending radius	
<i>Fixed laying:</i>	5 x d
<i>Flexible installation:</i>	10 x d
Radiation resistance:	up to $100 \times 10^6 \text{ cJ/kg}$ (up to 100 Mrad)

Features:

good EMC characteristics
flexible
small outer diameter
small bending radius
RoHS and CE approval



DATA CABLES

GAALFLEX® DATA 300 CP

PUR data cable with overall copper screen

ELETTROTEK KABEL® GAALFLEX® DATA 300 CP



Part no.	No. of cores x cross section n x mm ²	Outer-Ø ca. mm ± 10%	Copper weight kg/km	Cable weight approx. kg/km	AWG no. *)
35220C64020M01	2 x 0,14	4	12,3	21	26
35220C64030M01	3 x 0,14	4,1	14	25	26
35220C64040M01	4 x 0,14	4,4	15,7	29	26
35220C64050M01	5 x 0,14	4,8	19,5	35	26
35220C64070M01	7 x 0,14	5,1	23,4	41	26
35220C64100M01	10 x 0,14	6,2	28,5	54	26
35220C64120M01	12 x 0,14	6,5	34,3	64	26
35220C64140M01	14 x 0,14	6,8	39,9	74	26
35220C64180M01	18 x 0,14	7,7	51,5	93	26
35220C64210M01	21 x 0,14	8	60,1	108	26
35220C64250M01	25 x 0,14	8,8	71,9	128	26
35220D64020M02	2 x 0,25	4,5	14,7	26	24
35220D64030M02	3 x 0,25	4,7	17,1	33	24
35220D64040M02	4 x 0,25	5	20,6	38	24
35220D64050M02	5 x 0,25	5,4	24,8	44	24
35220D64070M02	7 x 0,25	5,8	31,1	53	24
35220D64100M02	10 x 0,25	7,2	42	79	24
35220D64120M02	12 x 0,25	7,7	51	92	24
35220D64140M02	14 x 0,25	8,1	60,1	105	24
35220D64180M02	18 x 0,25	9	77,9	128	24
35220D64210M02	21 x 0,25	9,6	91,4	148	24
35220D64250M02	25 x 0,25	10,7	110,8	175	24
35220D64020M03	2 x 0,34	5	17	33	22
35220D64030M03	3 x 0,34	5,2	20,7	42	22
35220D64040M03	4 x 0,34	5,6	24,7	48	22
35220D64050M03	5 x 0,34	6,2	30,1	57	22
35220D64070M03	7 x 0,34	6,7	38,2	77	22
35220D64100M03	10 x 0,34	8,4	63,1	111	22
35220D64120M03	12 x 0,34	8,9	74,2	128	22
35220D64140M03	14 x 0,34	9,3	85,3	144	22
35220D64180M03	18 x 0,34	10,2	107,4	175	22
35220D64210M03	21 x 0,34	10,9	124,1	200	22
35220D64250M03	25 x 0,34	11,9	147	233	22
35220D64020M05	2 x 0,5	5,4	23,2	38	20
35220D64030M05	3 x 0,5	5,6	30,1	51	20
35220D64040M05	4 x 0,5	6,2	35,4	58	20
35220D64050M05	5 x 0,5	6,7	52,6	77	20
35220D64070M05	7 x 0,5	7,2	65,3	93	20
35220D64100M05	10 x 0,5	9,3	88,8	134	20
35220D64120M05	12 x 0,5	9,7	101,9	155	20
35220D64140M05	14 x 0,5	10,2	115,1	175	20
35220D64180M05	18 x 0,5	11,4	141,2	214	20
35220D64210M05	21 x 0,5	11,9	161,1	245	20
35220D64250M05	25 x 0,5	13,1	187,9	285	20

Other dimension and colours available on request.

DATA CABLES

GAALFLEX® DATA 300 TP P

paired PUR data cable with drain wire and overall copper screen

ELETTROTEK KABEL® GAALFLEX® DATA 300 TP P

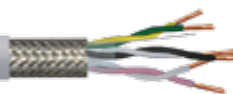

Construction:

Conductor:	flexible red copper conductor Cl. 5, acc to IEC 60228, DIN VDE 0295
Insulation:	PVC type YI2 acc. to DIN VDE 0207 part. 4
Colour cores:	acc. to DIN 47100
Stranding:	cores twisted to pairs, pairs stranded in layers
Wrapping:	PETP foil
Screen:	tinned copper braid + tinned copper drain wire (0,34mm ²)
Outer sheath:	blue (RAL 7001), or PUR compound

Resistance:



Self-extinguishing and flame retardant acc. to:
DIN VDE 0482 part 265-2-1
EN 50265-2-1
IEC 60332-1-2



Oil resistance acc. to:
DIN VDE 0473 part 811-2-1
IEC EN 60811-2-1

Technical data:

Nominal voltage:	< 0,25 mm ² = max. 350 V ≥ 0,25 mm ² = max. 500 V
Test voltage:	< 0,34 mm ² = max. 800 V ≥ 0,34 mm ² = max. 1,2 kV
Temperature range	
<i>Fixed laying:</i>	-30°C up to +70°C
<i>Flexible installation:</i>	-5°C up to +70°C
Min. bending radius	
<i>Fixed laying:</i>	5 x d
<i>Flexible installation:</i>	10 x d
Radiation resistance:	8 x 10 ⁷ cJ/kg

Features:

on request tinned copper conductor
on request grey (RAL 7032)
good EMC characteristics
flexible
small outer diameter
small bending radius
on request:
acc. to DIN VDE 0482 part 265-5-2 / EN 50266-5-2 /
IEC 60332-3-24
identified with "5" on the 5th number of the Part. no

RoHS and CE approva



DATA CABLES

GAALFLEX® DATA 300 TP P

paired PUR data cable with drain wire and overall copper screen

ELETTROTEK KABEL® GAALFLEX® DATA 300 TP P

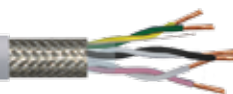

Part no.	No. of cores x cross section n x mm ²	Outer-Ø ca. mm ± 10%	Copper weight kg/km	Cable weight approx. kg/km	AWG no. *)
35170C54022M01	2 x 2 x 0,14	5,2	19,1	34	26
35170C54032M01	3 x 2 x 0,14	5,7	23,4	41	26
35170C54042M01	4 x 2 x 0,14	6,5	27,8	53	26
35170C54052M01	5 x 2 x 0,14	7	31,9	60	26
35170C54062M01	6 x 2 x 0,14	7,2	36,2	68	26
35170C54082M01	8 x 2 x 0,14	7,8	43,4	80	26
35170C54102M01	10 x 2 x 0,14	8,9	50,6	100	26
35170C54122M01	12 x 2 x 0,14	9,7	58,2	111	26
35170C54162M01	16 x 2 x 0,14	10,5	71,4	136	26
35170C54182M01	18 x 2 x 0,14	11,1	92,8	159	26
35170C54202M01	20 x 2 x 0,14	11,1	98,1	164	26
35170C54242M01	24 x 2 x 0,14	12,8	114,8	203	26
35170C54252M01	25 x 2 x 0,14	12,8	117,5	207	26
35170C54282M01	28 x 2 x 0,14	13,1	125,7	221	26
35170C54302M01	30 x 2 x 0,14	13,8	135,6	237	26
35170C54362M01	36 x 2 x 0,14	14,6	157,8	275	26
35170C54402M01	40 x 2 x 0,14	14,9	168,2	296	26
35170C54442M01	44 x 2 x 0,14	16,3	205,9	348	26
35170C54522M01	52 x 2 x 0,14	17	228,1	388	26
35170C54612M01	61 x 2 x 0,14	18,3	263,2	443	26
35170D54022M02	2 x 2 x 0,25	5,7	24,9	42	24
35170D54032M02	3 x 2 x 0,25	6,4	31,4	55	24
35170D54042M02	4 x 2 x 0,25	7,8	44,9	81	24
35170D54062M02	6 x 2 x 0,25	7,9	50,7	85	24
35170D54082M02	8 x 2 x 0,25	9	62,1	109	24
35170D54102M02	10 x 2 x 0,25	9,8	73,9	132	24
35170D54122M02	12 x 2 x 0,25	10,9	101,9	160	24
35170D54162M02	16 x 2 x 0,25	11,9	126,8	195	24
35170D54182M02	18 x 2 x 0,25	12,7	136,6	222	24
35170D54242M02	24 x 2 x 0,25	14,2	170,3	270	24
35170D54022M03	2 x 2 x 0,34	6,8	31,5	57	22
35170D54032M03	3 x 2 x 0,34	7,4	39,7	72	22
35170D54042M03	4 x 2 x 0,34	8,8	49,8	99	22
35170D54052M03	5 x 2 x 0,34	9,5	58,5	116	22
35170D54062M03	6 x 2 x 0,34	9,7	65,1	128	22
35170D54082M03	8 x 2 x 0,34	10,6	80,7	144	22
35170D54122M03	12 x 2 x 0,34	13,4	133,1	225	22
35170D54162M03	16 x 2 x 0,34	14,6	165	280	22
35170D54182M03	18 x 2 x 0,34	15,1	178,3	306	22
35170D54242M03	24 x 2 x 0,34	17,6	255,1	415	22
35170D54022M05	2 x 2 x 0,5	7,2	39,3	66	20
35170D54032M05	3 x 2 x 0,5	7,9	50,1	84	20
35170D54042M05	4 x 2 x 0,5	9,6	82	126	20
35170D54062M05	6 x 2 x 0,5	10,4	86	146	20
35170D54082M05	8 x 2 x 0,5	10,9	111,5	166	20
35170D54122M05	10 x 2 x 0,5	13,2	146,5	229	20
35170D54122M05	12 x 2 x 0,5	14,4	175,7	268	20
35170D54162M05	16 x 2 x 0,5	16,3	241,3	368	20
35170D54182M05	18 x 2 x 0,5	16,9	261	399	20
35170D54202M05	20 x 2 x 0,5	16,9	280,2	418	20
35170D54242M05	24 x 2 x 0,5	19	330,4	491	20
35170D54022M07	2 x 2 x 0,75	8,5	52,4	92	19
35170D54032M07	3 x 2 x 0,75	9,4	69,4	112	19
35170D54042M07	4 x 2 x 0,75	10,9	108,0	179	19
35170D54062M07	6 x 2 x 0,75	12,5	136,5	218	19
35170D54082M07	8 x 2 x 0,75	14,9	180	305	19
35170D54122M07	12 x 2 x 0,75	17,1	261,2	385	19
35170D54162M07	16 x 2 x 0,75	18,6	329,9	482	19
35170D54182M07	18 x 2 x 0,75	19,3	369,3	535	19
35170D54242M07	24 x 2 x 0,75	21,8	469,2	661	19
35170D54022M10	2 x 2 x 1	10,5	84	142	18
35170D54032M10	3 x 2 x 1	10,6	96	173	18
35170D54042M10	4 x 2 x 1	11,5	121	212	18
35170D54052M10	5 x 2 x 1	12,0	161	266	18

Other dimension and colours available on request.

DATA CABLES

GAALFLEX® DATA 300 IN TP

paired/triads PUR data cable with drain wire individual and overall aluminium tape screen, 300/500 V



Construction:

Conductor:	flexible red copper conductor Cl. 5, acc to IEC 60228, DIN VDE 0295
Insulation:	PVC type R2
Colour cores:	pairs: blue-black, with black progressively numbered. triads: blue-brown-black, with black progressively numbered.
Stranding:	cores twisted in pairs/triads, pairs/triads twisted in layers
Screen:	
<i>Individual:</i>	aluminium tape + PETP foil + tinned copper drain wire
<i>Overall:</i>	aluminium tape + PETP foil + tinned copper drain wire
Outer sheath:	black (RAL 9005) or blue (RAL 5015), PUR compound

Resistance:



Self-extinguishing and flame retardant acc. to:
DIN VDE 0482 part 265-2-1
EN 50265-2-1
IEC 60332-1-2



Low smoke emission acc. to:
DIN VDE 0482 part.268-2
EN 50268-2,
IEC 61034-1

Technical data:

Nominal voltage:	300/500 V
Test voltage:	2000 V
Temperature range	
<i>Fixed laying:</i>	-30°C up to +70°C
<i>Flexible installation:</i>	-5°C up to +70°C
<i>Max. short circuit temperature:</i>	up to + 160°C
Min. bending radius	
<i>Fixed laying:</i>	10 x d
<i>Flexible installation:</i>	/
Radiation resistance:	8×10^7 cJ/kg

Features:

on request tinned copper conductor
cores identification acc. to CEI UNEL 00725
acc. to standard EN 50288-7
on request:
acc. to DIN VDE 0482 part 265-5-2 / EN 50266-5-2 / IEC 60332-3-24
identified with "5" on the 5th number of the Part. no
RoHS and CE approva



DATA CABLES

GAALFLEX® DATA 300 IN TP

paired/triads PUR data cable with drain wire individual and overall aluminium tape screen, 300/500 V



Part no.	No. of cores x cross section n x mm ²	Outer-Ø ca. mm ± 10%	Copper weight kg/km	Cable weight approx. kg/km	AWG no. *)
35200D7X022M05	2x2x0,50	8,5	30	65	20
35200D7X032M05	3x2x0,50	9,4	45	75	20
35200D7X042M05	4x2x0,50	10,2	61	105	20
35200D7X062M05	6x2x0,50	13	92	170	20
35200D7X122M05	12x2x0,50	17	110	225	20
35200D7X242M05	24x2x0,50	23	160	305	20
35200D7X022M07	2x2x0,75	8,8	43,2	90	19
35200D7X032M07	3x2x0,75	9,7	70	125	19
35200D7X042M07	4x2x0,75	10,8	81,6	150	19
35200D7X062M07	6x2x0,75	13,3	157	290	19
35200D7X122M07	12x2x0,75	18	235,2	397	19
35200D7X242M07	24x2x0,75	25,5	320	589	19
35200D7X022M10	2x2x1	9,1	53	110	18
35200D7X032M10	3x2x1	10,2	91	155	18
35200D7X042M10	4x2x1	11,4	115	220	18
35200D7X062M10	6x2x1	13,9	178	325	18
35200D7X122M10	12x2x1	19,4	372	620	18
35200D7X242M10	24x2x1	28	510	980	18
35200D7X022M15	2x2x1,5	10	67	125	16
35200D7X032M15	3x2x1,5	11,1	132	250	16
35200D7X042M15	4x2x1,5	12,3	168	312	16
35200D7X062M15	6x2x1,5	15,2	223	455	16
35200D7X122M15	12x2x1,5	21,9	495	890	16
35200D7X242M15	24x2x1,5	32	680	1200	16
35200D7X023M05	2x3x0,50	9,6	40	78	20
35200D7X033M05	3x3x0,50	10,3	65	95	20
35200D7X043M05	4x3x0,50	10,5	84	140	20
35200D7X063M05	6x3x0,50	13,6	130	210	20
35200D7X123M05	12x3x0,50	17,5	190	345	20
35200D7X243M05	24x3x0,50	24	250	470	20
35200D7X023M07	2x3x0,75	10,5	57,6	125	19
35200D7X033M07	3x3x0,75	10,8	80	156	19
35200D7X043M07	4x3x0,75	11,6	110,4	210	19
35200D7X063M07	6x3x0,75	14	187	340	19
35200D7X123M07	12x3x0,75	19	270	496	19
35200D7X243M07	24x3x0,75	26,5	410	780	19
35200D7X023M10	2x3x1	10,9	78	145	18
35200D7X033M10	3x3x1	11,3	115	195	18
35200D7X043M10	4x3x1	12,5	156	295	18
35200D7X063M10	6x3x1	14,5	247	478	18
35200D7X123M10	12x3x1	20,4	430	770	18
35200D7X243M10	24x3x1	29,3	615	1180	18
35200D7X023M15	2x3x1,5	11	95	178	16
35200D7X033M15	3x3x1,5	11,5	198	350	16
35200D7X043M15	4x3x1,5	13,8	228	405	16
35200D7X063M15	6x3x1,5	17,1	310	585	16
35200D7X123M15	12x3x1,5	23	570	1050	16
35200D7X243M15	24x3x1,5	35	870	1470	16

Other dimension and colours available on request.



TRACK CABLES



TRACK CABLES

GAALFLEX® CHAIN TD 87

Continuously flexible PVC data cable with colored cores, DIN VDE max. 350 V (UL) 300V



ELETTROTEK KABEL® GAALFLEX® CHAIN TD 87



Construction:

Conductor:	flexible red copper conductor Cl. 6, acc to IEC 60228, DIN VDE 0295
Insulation:	PVC type TI2, acc. to DIN VDE 0281 part 1 + HD 21.1
Colour cores:	acc. to DIN 47100
Stranding:	in layers
Wrapping:	non woven tape over each layer
Outer sheath:	grey (RAL 7032), PVC type TM2, acc. to to DIN VDE 0281 part 1 + HD 21.1

Resistance:



Self-extinguishing and flame retardant acc. to:
DIN VDE 0482 part 265-2-1
EN 50265-2-1
IEC 60332-1-2
UL VW-1



Oil resistance acc. to:
DIN VDE 0473 part 811-2-1
IEC EN 60811-2-1

Technical data:

Nominal voltage:	DIN VDE: max. 350 V UL: 300 V
Test voltage:	1,5 kV acc. to DIN VDE 0472 part 509
Temperature range	DIN VDE: UL/CSA:
<i>Fixed laying:</i>	-30°C up to +80°C up to +80°C
<i>Flexible installation:</i>	-5°C up to +80°C
Radiation resistance:	8 x 10 ⁷ cj/kg
Min. bending radius	
<i>Continuously flexible:</i>	7,5 x d
Max speed (main application):	180 m/min

Features:

- AWM Style 2464 80°C 300V
- good flexibility
- small outer diameter
- small bending radius
- for SPEEDS and MINIMUM BENDING RADIUS see pages from 2 to 8 of catalogue
- RoHS and CE approval



Part no.	No. of cores x cross section n x mm ²	Outer-Ø ca.mm ± 10%	Copper weight kg/km	Cable weight approx. kg/km	AWG no. *)
36080C64020A26	2 x 0,14	4,1	2,7	20	26
36080C64030A26	3 x 0,14	4,3	4	25	26
36080C64040A26	4 x 0,14	4,7	5,4	30	26
36080C64050A26	5 x 0,14	5,1	6,7	35	26
36080C64070A26	7 x 0,14	5,9	9,4	45	26
36080C64100A26	10 x 0,14	6,9	13,4	55	26
36080C64140A26	14 x 0,14	7,4	18,8	70	26
36080C64180A26	18 x 0,14	8,4	24,2	90	26
36080C64250A26	25 x 0,14	10,4	33,6	120	26
36080C64020A24	2 x 0,25	4,4	4,8	25	24
36080C64030A24	3 x 0,25	4,5	7,2	30	24
36080C64040A24	4 x 0,25	5	9,6	35	24
36080C64050A24	5 x 0,25	5,5	12	45	24
36080C64070A24	7 x 0,25	6,5	16,8	55	24
36080C64100A24	10 x 0,25	7,5	24	70	26
36080C64140A24	14 x 0,25	8,3	33,6	95	24
36080C64180A24	18 x 0,25	9,2	43,2	120	24
36080C64250A24	25 x 0,25	11,2	60	160	24
36080C64020A22	2 x 0,34	4,6	6,5	35	22
36080C64030A22	3 x 0,34	4,9	9,8	35	22
36080C64040A22	4 x 0,34	5,3	13,1	40	22
36080C64050A22	5 x 0,34	5,7	16,3	50	22
36080C64070A22	7 x 0,34	6,8	22,8	65	22
36080C64100A22	10 x 0,34	8,1	32,6	85	26
36080C64140A22	14 x 0,34	8,7	45,7	110	22
36080C64180A22	18 x 0,34	9,8	58,8	140	22
36080C64250A22	25 x 0,34	12	81,6	190	22

Other dimension and colours available on request.

TRACK CABLES

GAALFLEX® CHAIN T 87

Continuously flexible PVC control cable, DIN VDE 300/500 V UL/CSA 600 V



ELETTROTEK KABEL® GAALFLEX® CHAIN T 87



Construction:

Conductor:	flexible red copper conductor Cl. 6, acc to IEC 60228, DIN VDE 0295
Insulation:	PVC compound
Colour cores:	black cores with consecutive numbers acc. to EN 50334, green-yellow from 3 cores
Stranding:	in layers
Wrapping:	non woven tape over each layer
Outer sheath:	grey (RAL 7000 or 7001), PVC compound

Resistance:



Self-extinguishing and flame retardant acc. to:
 DIN VDE 0482 part 265-2-1
 EN 50265-2-1
 IEC 60332-1-2
 IEC 60332-3-24
 UL VW-1, CSA FT1



Oil resistance acc. to:
 DIN EN 50290-2-22 TM 54

Technical data:

Nominal voltage:	DIN VDE: U ₀ /U 300/500 V UL: 600 V
Test voltage:	3 kV acc. to DIN VDE 0281 part 2 + HD 21.2
Temperature range	DIN VDE: -40°C up to +80°C UL/CSA: up to +90°C
<i>Fixed laying:</i>	-40°C up to +80°C
<i>Flexible installation:</i>	-0°C up to +80°C
Radiation resistance:	8 x 10 ⁻⁷ cJ/kg
Min. bending radius	
<i>Continuously flexible:</i>	7,5 x d
Max speed (main application):	180 m/min

Features:

UL AWM Style 2587 90°C 600V
 CSA AWM I/II A/B 90°C 600V FT1 CE
 good flexibility
 small outer diameter
 small bending radius
 for SPEEDS and MINIMUM BENDING RADIUS
 see pages from 2 to 8 of catalogue
 RoHS and CE approval



Part no.	No. of cores x cross section n x mm ²	Outer-Ø ca. mm ± 10%	Copper weight kg/km	Cable weight approx. kg/km	AWG no. *)
36090F41020A20	2 x 0,5	5,1	9,6	35	20
36090F40031A20	3 G 0,5	5,6	14,4	45	20
36090F40041A20	4 G 0,5	6,0	19,2	50	20
36090F40051A20	5 G 0,5	6,5	24	60	20
36090F40071A20	7 G 0,5	7,7	33,6	85	20
36090F40081A20	8 G 0,5	7,8	38,4	100	20
36090F40121A20	12 G 0,5	9,3	57,6	130	20
36090F40181A20	18 G 0,5	11,2	86,4	195	20
36090F40251A20	25 G 0,5	13,4	20	265	20
36090F40341A20	34 G 0,5	15,0	163,2	340	20
36090F40501A20	50 G 0,5	17,4	240	475	20
36090F40611A20	61 G 0,5	19,2	292,8	595	20
36090F41020A19	2 x 0,75	5,6	14,4	40	19
36090F40031A19	3 G 0,75	6,1	21,6	55	19
36090F40041A19	4 G 0,75	6,6	28,8	65	19
36090F40051A19	5 G 0,75	7,2	36	80	19
36090F40071A19	7 G 0,75	8,7	50,4	115	19
36090F40121A19	12 G 0,75	10,5	86,4	175	19
36090F40181A19	18 G 0,75	12,7	129,6	260	19
36090F40251A19	25 G 0,75	15,1	180	355	19
36090F40341A19	34 G 0,75	16,4	244,8	475	19
36090F40501A19	50 G 0,75	19,2	360	680	19
36090F40611A19	61 G 0,75	21,3	439,2	835	19

TRACK CABLES

GAALFLEX® CHAIN T 87

Continuously flexible PVC control cable, DIN VDE 300/500 V UL/CSA 600 V



ELETTROTEK KABEL® GAALFLEX® CHAIN T 87

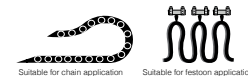

Part no.	No. of cores x cross section n x mm ²	Outer-Ø ca. mm ± 10%	Copper weight kg/km	Cable weight approx. kg/km	AWG no. *)
36090F41020A18	2 x 1	5,8	19,2	50	18
36090F40031A18	3 G 1	6,4	28,8	60	18
36090F40041A18	4 G 1	6,8	38,4	75	18
36090F40051A18	5 G 1	7,5	48	90	18
36090F40071A18	7 G 1	9,1	67,2	130	18
36090F40121A18	12 G 1	11,2	115,2	210	18
36090F40181A18	18 G 1	13,2	172,8	305	18
36090F40251A18	25 G 1	16	240	425	18
36090F40341A18	34 G 1	17,1	326,4	570	18
36090F40501A18	50 G 1	20,5	480	830	18
36090F40611A18	61 G 1	22,3	585,6	1000	18
36090F41020A16	2 x 1,5	6,4	28,8	60	16
36090F40031A16	3 G 1,5	7	43,2	80	16
36090F40041A16	4 G 1,5	7,6	57,6	100	16
36090F40051A16	5 G 1,5	8,5	72	130	16
36090F40071A16	7 G 1,5	10,3	100,8	180	16
36090F40121A16	12 G 1,5	12,6	172,8	285	16
36090F40181A16	18 G 1,5	14,9	259,2	415	16
36090F40251A16	25 G 1,5	18	360	580	16
36090F40341A16	34 G 1,5	19,1	489,6	780	16
36090F40501A16	50 G 1,5	22,8	720	1120	16
36090F40611A16	61 G 1,5	25	878,4	1365	16
36090F41020A14	2 x 2,5	7,4	48	100	14
36090F40031A14	3 G 2,5	8,6	72	125	14
36090F40041A14	4 G 2,5	9,3	96	150	14
36090F40051A14	5 G 2,5	10,4	120	200	14
36090F40071A14	7 G 2,5	12,7	168	285	14
36090F40121A14	12 G 2,5	15,6	288	450	14
36090F40181A14	18 G 2,5	18,8	432	650	14
36090F40251A14	25 G 2,5	22,8	600	880	14
36090F40031A12	3 G 4	10,2	115,2	185	12
36090F40041A12	4 G 4	11,2	153,6	240	12
36090F40051A12	5 G 4	12,6	192	300	12
36090F40071A12	7 G 4	15,1	268,8	445	12
36090F40031A10	3 G 6	12,5	172,8	275	10
36090F40041A10	4 G 6	13,5	230,4	350	10
36090F40051A10	5 G 6	15,4	288	445	10
36090F40071A10	7 G 6	17,7	403,2	640	10
36090F40031A08	3 G 10	14,6	288	455	8
36090F40041A08	4 G 10	17,6	384	584	8
36090F40051A08	5 G 10	19,8	480	739	6
36090F40031A06	3 G 16	17,7	460,8	680	6
36090F40041A06	4 G 16	20,7	614,4	870	6
36090F40051A06	5 G 16	23,3	768	1100	6
36090F40041A04	4 G 25	23,6	960	1300	4
36090F40051A04	5 G 25	26,4	1200	1650	4
36090F40041A02	4 G 35	27	1344	1800	2
36090F40051A02	5 G 35	29,9	1680	2200	2
36090F40041A01	4 G 50	31,5	1920	2500	1

Other dimension and colours available on request.

TRACK CABLES

GAALFLEX® CHAIN TD 87 C

Continuously flexible PVC data cable with colored cores and overall copper screen, DIN VDE max. 350 V (UL) 300 V



ELETTROTEK KABEL® GAALFLEX® CHAIN TD 87 C



Construction:

Conductor:	flexible red copper conductor Cl. 6, acc to IEC 60228, DIN VDE 0295
Insulation:	PVC type T12, acc. to DIN VDE 0281 part 1 + HD 21.1
Colour cores:	acc. to DIN 47100
Stranding:	in layers
Wrapping:	non woven tape over each layer
Screen:	tinned copper braid
Wrapping:	non woven tape
Outer sheath:	grey (RAL 7032), PVC type TM2, acc. to DIN VDE 0281 part 1 + HD 21.1

Resistance:



Self-extinguishing and flame retardant acc. to:
DIN VDE 0482 part 265-2-1
EN 50265-2-1
IEC 60332-1-2
UL VW-1



Oil resistance acc. to:
DIN VDE 0473 part 811-2-1
IEC EN 60811-2-1

Technical data:

Nominal voltage:	DIN VDE: max. 350 V UL: 300 V
Test voltage:	1,5 kV acc. to DIN VDE 0472 part 509 core/screen 1,2 kV
Temperature range	DIN VDE: -30°C up to +80°C UL/CSA: up to +80°C
<i>Fixed laying:</i>	-30°C up to +80°C
<i>Flexible installation:</i>	-5°C up to +80°C
Radiation resistance:	8 x 10 ⁷ cj/kg
Min. bending radius	
<i>Continuously flexible:</i>	7,5 x d
Max speed (main application):	180 m/min

Features:

- AWM Style 2464 80°C 300V
- very good flexibility
- small outer diameter
- small bending radius
- good EMC characteristics
- for SPEEDS and MINIMUM BENDING RADIUS see pages from 2 to 8 of catalogue
- RoHS and CE approval



Part no.	No. of cores x cross section n x mm ²	Outer-Ø ca. mm ± 10%	Copper weight kg/km	Cable weight approx. kg/km	AWG no. (*)
36100C64020A26	2 x 0,14	4,8	13,8	30	26
36100C64030A26	3 x 0,14	5	15,7	35	26
36100C64040A26	4 x 0,14	5,5	19,4	40	26
36100C64050A26	5 x 0,14	5,8	22,6	45	26
36100C64070A26	7 x 0,14	6,7	26,1	60	26
36100C64100A26	10 x 0,14	7,7	45,7	70	26
36100C64140A26	14 x 0,14	8,8	56,4	90	26
36100C64180A26	18 x 0,14	9,5	64,7	110	26
36100C64250A26	25 x 0,14	11,3	84,4	150	26
36100C64020A24	2 x 0,25	5,2	18	35	24
36100C64030A24	3 x 0,25	5,5	20,7	40	24
36100C64040A24	4 x 0,25	5,8	25,5	45	24
36100C64050A24	5 x 0,25	6,5	28,3	55	24
36100C64070A24	7 x 0,25	7,3	46,3	65	24
36100C64100A24	10 x 0,25	8,8	61,7	95	24
36100C64140A24	14 x 0,25	9,5	72,1	115	24
36100C64180A24	18 x 0,25	10,4	93,2	140	24
36100C64250A24	25 x 0,25	12,8	115,8	205	24
36100C64020A22	2 x 0,34	5,4	19,9	35	22
36100C64030A22	3 x 0,34	5,7	25,4	40	22
36100C64040A22	4 x 0,34	6	29,1	50	22
36100C64050A22	5 x 0,34	6,6	44,5	60	22
36100C64070A22	7 x 0,34	7,6	54,9	75	22
36100C64100A22	10 x 0,34	9	70,9	105	22
36100C64140A22	14 x 0,34	9,9	86,8	130	22
36100C64180A22	18 x 0,34	11	109,4	170	22
36100C64250A22	25 x 0,34	13,3	139,1	230	22

Other dimension and colours available on request.

TRACK CABLES

GAALFLEX® CHAIN T 87 C Lean

Continuously flexible PVC control cable with overall copper screen, DIN VDE 300/500 V UL/CSA 600 V



ELETTROTEK KABEL® GAALFLEX® CHAIN T 87 C Lean



Construction:

Conductor:	flexible red copper conductor Cl. 6, acc to IEC 60228, DIN VDE 0295
Insulation:	PVC compound
Colour cores:	black cores with consecutive numbers acc. to EN 50334, green-yellow from 3 cores
Stranding:	in layers
Wrapping:	non woven tape over each layer
Screen:	tinned copper braid
Wrapping:	non-woven tape
Outer sheath:	grey (RAL 7000 or 7001), PVC compound

Resistance:



Self-extinguishing and flame retardant acc. to:

DIN VDE 0482 part 265-2-1
EN 50265-2-1
IEC 60332-1-2
IEC 60332-3-24
UL VW-1, CSA FT1



Oil resistance acc. to:

DIN EN 50290-2-22 TM 54

Technical data:

Nominal voltage:	DIN VDE: U ₀ /U 300/500 V UL: 600 V
Test voltage:	3 kV acc. to DIN VDE 0281 part 2 + HD 21.2
Temperature range	DIN VDE: -30°C up to +80°C UL/CSA: up to +90°C
<i>Fixed laying:</i>	-30°C up to +80°C
<i>Flexible installation:</i>	-5°C up to +80°C
Radiation resistance:	8 x 10 ⁷ cJ/kg
Min. bending radius	
<i>Continuously flexible:</i>	8 x d
Max speed (main application):	180 m/min

Features:

AWM Style 2587 90°C 600V
CSA AWM I/II A/B 90°C 600V FT1 CE

very good flexibility

small outer diameter

small bending radius

good EMC characteristics

for SPEEDS and MINIMUM BENDING RADIUS see pages from 2 to 8 of catalogue

RoHS and CE approval



TRACK CABLES

GAALFLEX® CHAIN T 87 C Lean

Continuously flexible PVC control cable with overall copper screen, DIN VDE 300/500 V UL/CSA 600 V



ELETTROTEK KABEL® GAALFLEX® CHAIN T 87 C Lean



Part no.	No. of cores x cross section n x mm ²	Outer-Ø ca. mm ± 10%	Copper weight kg/km	Cable weight approx. kg/km	AWG no. *)
36380F51020A20	2 x 0,5	5,7	27	50	20
36380F50031A20	3 G 0,5	6,2	32	60	20
36380F50041A20	4 G 0,5	6,6	42	75	20
36380F50051A20	5 G 0,5	7,1	47	85	20
36380F50071A20	7 G 0,5	8,5	62	115	20
36380F50121A20	12 G 0,5	10,1	92	165	20
36380F50181A20	18 G 0,5	11,8	132	230	20
36380F50251A20	25 G 0,5	14,4	190	330	20
36380F51020A19	2 x 0,75	6,2	32	60	19
36380F50031A19	3 G 0,75	6,7	44	75	19
36380F50041A19	4 G 0,75	7,2	52	90	19
36380F50051A19	5 G 0,75	7,8	64	105	19
36380F50071A19	7 G 0,75	9,5	84	150	19
36380F50121A19	12 G 0,75	11,3	126	215	19
36380F50181A19	18 G 0,75	13,3	181	300	19
36380F50251A19	25 G 0,75	16,1	260	430	19
36380F51020A18	2 x 1	6,4	42	70	18
36380F50031A18	3 G 1	7	51	85	18
36380F50041A18	4 G 1	7,4	61	100	18
36380F50051A18	5 G 1	8,3	76	125	18
36380F50071A18	7 G 1	9,9	101	165	18
36380F50121A18	12 G 1	11,8	160	250	18
36380F50181A18	18 G 1	14,2	243	370	18
36380F50251A18	25 G 1	17	320	500	18
36380F51020A16	2 x 1,5	7	51	85	16
36380F50031A16	3 G 1,5	7,6	72	105	16
36380F50041A16	4 G 1,5	8,4	86	135	16
36380F50051A16	5 G 1,5	9,1	106	160	16
36380F50071A16	7 G 1,5	11,1	140	220	16
36380F50121A16	12 G 1,5	13,2	224	330	16
36380F50181A16	18 G 1,5	15,9	340	490	16
36380F50251A16	25 G 1,5	19	461	670	16
36380F51020A14	2 x 2,5	8,9	89	140	14
36380F50031A14	3 G 2,5	9,2	106	155	14
36380F50041A14	4 G 2,5	10,1	130	195	14
36380F50051A14	5 G 2,5	11,2	160	235	14
36380F50071A14	7 G 2,5	13,3	219	325	14
36380F50121A14	12 G 2,5	16,4	369	520	14
36380F50181A14	18 G 2,5	18,1	517	690	14
36380F50251A14	25 G 2,5	21,7	706	915	14
36380F50031A12	3 G 4	10,7	165	235	12
36380F50041A12	4 G 4	11,8	199	280	12
36380F50051A12	5 G 4	13,2	243	340	12
36380F50031A10	3 G 6	13,4	220	355	10
36380F50041A10	4 G 6	14,5	301	425	10
36380F50051A10	5 G 6	16,2	369	515	10
36380F50041A08	4 G 10	18,6	475	670	8
36380F50051A08	5 G 10	19,2	588	820	8
36380F50041A06	4 G 16	21,7	725	980	6
36380F50051A06	5 G 16	22,4	860	1210	6
36380F50041A04	4 G 25	24	1040	1515	4
36380F50051A04	5 G 25	27,7	1290	1790	4
36380F50041A02	4 G 35	27	1415	1910	2
36380F50041A01	4 G 50	28,1	1970	2715	1

Other dimension and colours available on request.

TRACK CABLES

GAALFLEX® CHAIN T 87 C

Continuously flexible PVC control cable with overall copper screen, DIN VDE 300/500 V UL/CSA 600 V



ELETTROTEK KABEL® GAALFLEX® CHAIN T 87 C



Construction:

Conductor:	flexible red copper conductor Cl. 6, acc to IEC 60228, DIN VDE 0295
Insulation:	PVC compound
Colour cores:	black cores with consecutive numbers acc. to EN 50334, green-yellow from 3 cores
Stranding:	in layers
Wrapping:	non woven tape over each layer
Inner sheath:	PVC compound
Screen:	tinned copper braid
Wrapping:	non-woven tape
Outer sheath:	grey (RAL 7000 or 7001), PVC compound

Resistance:



Self-extinguishing and flame retardant acc. to:

DIN VDE 0482 part 265-2-1
EN 50265-2-1
IEC 60332-1-2
UL VW-1, CSA FT1 FT2



Oil resistance acc. to:

DIN VDE 0473 part 811-2-1
IEC EN 60811-2-1

Technical data:

Nominal voltage:	DIN VDE: U _o /U 300/500 V UL: 600 V
Test voltage:	3 kV acc. to DIN VDE 0281 part 2 + HD 21.2
Temperature range	DIN VDE: -30°C up to +80°C UL/CSA: up to +90°C
<i>Fixed laying:</i>	-30°C up to +80°C
<i>Flexible installation:</i>	-5°C up to +80°C
Radiation resistance:	8 x 10 ⁷ cJ/kg
Min. bending radius	
<i>Continuously flexible:</i>	7,5 x d
Max speed (main application):	180 m/min

Features:

AWM Style 2587 90°C 600V
CSA AWM I/II A/B 90°C 600V FT1 FT2 CE

very good flexibility

small outer diameter

small bending radius

good EMC characteristics

for SPEEDS and MINIMUM BENDING RADIUS
see pages from 2 to 8 of catalogue

RoHS and CE approval



TRACK CABLES

GAALFLEX® CHAIN T 87 C

Continuously flexible PVC control cable with overall copper screen, DIN VDE 300/500 V UL/CSA 600 V



ELETTROTEK KABEL® GAALFLEX® CHAIN T 87 C



Part no.	No. of cores x cross section n x mm ²	Outer-Ø ca. mm ± 10%	Copper weight kg/km	Cable weight approx. kg/km	AWG no. *)
36110F41020A20	2 x 0,5	7,6	42,5	80	20
36110F40031A20	3 G 0,5	8,1	48,3	95	20
36110F40041A20	4 G 0,5	8,6	56	105	20
36110F40051A20	5 G 0,5	9	64,6	125	20
36110F40071A20	7 G 0,5	10,4	78,7	165	20
36110F40121A20	12 G 0,5	12,6	119	245	20
36110F40181A20	18 G 0,5	14,5	172,4	340	20
36110F40251A20	25 G 0,5	17	234,2	445	20
36110F41020A19	2 x 0,75	8,1	51,7	90	19
36110F40031A19	3 G 0,75	9	59,2	105	19
36110F40041A19	4 G 0,75	9	67,5	125	19
36110F40051A19	5 G 0,75	9,8	77	145	19
36110F40071A19	7 G 0,75	11,2	101,2	190	19
36110F40121A19	12 G 0,75	13,6	146,3	280	19
36110F40181A19	18 G 0,75	15,6	227,3	390	19
36110F40251A19	25 G 0,75	18,7	292	525	19
36110F41020A18	2 x 1	8,5	56,7	100	18
36110F40031A18	3 G 1	8,8	66,6	115	18
36110F40041A18	4 G 1	9,3	77,3	135	18
36110F40051A18	5 G 1	10,1	89,5	160	18
36110F40071A18	7 G 1	11,7	122	220	18
36110F40121A18	12 G 1	14,1	200,9	335	18
36110F40181A18	18 G 1	16,4	271,2	460	18
36110F40251A18	25 G 1	19,4	368,2	610	18
36110F41020A16	2 x 1,5	9	67	120	16
36110F40031A16	3 G 1,5	9,5	83	140	16
36110F40041A16	4 G 1,5	10,5	102,5	165	16
36110F40051A16	5 G 1,5	11,1	123,7	215	16
36110F40071A16	7 G 1,5	13,1	160,4	290	16
36110F40121A16	12 G 1,5	15,6	270,5	425	16
36110F40181A16	18 G 1,5	18,2	370,3	590	16
36110F40251A16	25 G 1,5	21,7	498,6	795	16
36110F41020A14	2 x 2,5	11,1	98,7	185	14
36110F40031A14	3 G 2,5	11,6	127	225	14
36110F40041A14	4 G 2,5	12,7	156,3	270	14
36110F40051A14	5 G 2,5	14,1	205,5	345	14
36110F40071A14	7 G 2,5	15,5	270,2	440	14
36110F40121A14	12 G 2,5	19,8	419,4	655	14
36110F40181A14	18 G 2,5	22,6	573,9	915	14
36110F40251A14	25 G 2,5	27,1	783,5	1215	14
36110F40031A12	3 G 4	13,3	183,2	310	12
36110F40041A12	4 G 4	14,2	239,3	380	12
36110F40051A12	5 G 4	15,5	296,6	460	12
36110F40031A10	3 G 6	15,8	243,7	440	10
36110F40041A10	4 G 6	16,8	340,2	520	10
36110F40051A10	5 G 6	18,5	418,1	625	10
36110F40041A08	4 G 10	20,4	524,1	800	8
36110F40051A08	5 G 10	22,6	652,6	965	8
36110F40041A06	4 G 16	24	781,5	1100	6
36110F40051A06	5 G 16	26,3	954,2	1345	6
36110F40041A04	4 G 25	28,3	1158,2	1680	4
36110F40051A04	5 G 25	31,4	1429,7	1985	4
36110F40041A02	4 G 35	31,8	1575,3	2115	2
36110F40041A01	4 G 50	38	2181,8	3015	1

Other dimension and colours available on request.

TRACK CABLES

GAALFLEX® CHAIN TD 87 C TP

Continuously flexible paired PVC data cable with colored cores and overall copper screen
DIN VDE max. 350V (UL) 300V



ELETTROTEK KABEL® GAALFLEX® CHAIN TD 87 C TP



Construction:

Conductor:	flexible red copper conductor Cl. 6, acc to IEC 60228, DIN VDE 0295
Insulation:	PVC type T12, acc. to DIN VDE 0281 part 1 + HD 21.1
Colour cores:	acc. to DIN 47100
Stranding:	cores twisted in pairs, pairs twisted in layers
Wrapping:	non woven tape over each layer
Screen:	tinned copper braid
Wrapping:	non woven tape over each layer
Outer sheath:	grey (RAL 7032), PVC type TM2, acc. to DIN VDE 0281 part 1 + HD 21.1

Resistance:



Self-extinguishing and flame retardant acc. to:

DIN VDE 0482 part 265-2-1
EN 50265-2-1
IEC 60332-1-2
UL VW-1



Oil resistance acc. to:

DIN VDE 0473 part 811-2-1
IEC EN 60811-2-1

Technical data:

Nominal voltage:	DIN VDE: max. 350 V UL: 300 V
Test voltage:	1,5 kV acc. to DIN VDE 0472 part 509 core/screen 1,2 kV
Temperature range	DIN VDE: UL/CSA:
<i>Fixed laying:</i>	-30°C up to +80°C up to +80°C
<i>Flexible installation:</i>	-5°C up to +80°C
Radiation resistance:	8 x 10 ⁷ cj/kg
Min. bending radius	
<i>Continuously flexible:</i>	7,5 x d
Max speed (main application):	180 m/min

Features:

AWM AWM Style 2464 80°C 300V

good flexibility

small outer diameter

small bending radius

for SPEEDS and MINIMUM BENDING RADIUS
see pages from 2 to 8 of catalogue

RoHS and CE approval



TRACK CABLES

GAALFLEX® CHAIN TD 87 C TP

Continuously flexible paired PVC data cable with colored cores and overall copper screen
DIN VDE max. 350V (UL) 300V



ELETTROTEK KABEL® GAALFLEX® CHAIN TD 87 C TP

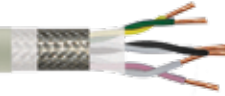

Part no.	No. of cores x cross section n x mm ²	Outer-Ø ca. mm ± 10%	Copper weight kg/km	Cable weight approx. kg/km	AWG no. *)
36120C64022A26	2 x 2 x 0,14	5,8	19,4	40	26
36120C64032A26	3 x 2 x 0,14	6,5	33	55	26
36120C64042A26	4 x 2 x 0,14	7,5	43,1	70	26
36120C64052A26	5 x 2 x 0,14	8	46,3	80	26
36120C64072A26	7 x 2 x 0,14	8,7	54	100	26
36120C64102A26	10 x 2 x 0,14	10,2	70,7	120	26
36120C64142A26	14 x 2 x 0,14	11,8	87,3	155	26
36120C64182A26	18 x 2 x 0,14	12,6	107	195	26
36120C64252A26	25 x 2 x 0,14	14,5	128,6	235	26
36120C64022A24	2 x 2 x 0,25	6,7	34,4	55	24
36120C64032A24	3 x 2 x 0,25	7,3	42,2	65	24
36120C64042A24	4 x 2 x 0,25	8,1	52,1	80	24
36120C64052A24	5 x 2 x 0,25	8,8	59,4	95	24
36120C64072A24	7 x 2 x 0,25	9,4	69,9	125	24
36120C64102A24	10 x 2 x 0,25	11	96,2	150	24
36120C64142A24	14 x 2 x 0,25	12,8	126,1	200	24
36120C64182A24	18 x 2 x 0,25	13,8	147	245	24
36120C64252A24	25 x 2 x 0,25	15,9	211,2	325	24
36120C64022A22	2 x 2 x 0,34	6,8	38,4	60	22
36120C64032A22	3 x 2 x 0,34	7,4	47,9	75	22
36120C64042A22	4 x 2 x 0,34	8,5	61	90	22
36120C64052A22	5 x 2 x 0,34	9,2	68,6	110	22
36120C64072A22	7 x 2 x 0,34	9,9	89,4	150	22
36120C64102A22	10 x 2 x 0,34	11,6	114,6	170	22
36120C64142A22	14 x 2 x 0,34	13,6	151,4	225	22
36120C64182A22	18 x 2 x 0,34	14,8	205,9	305	22
36120C64252A22	25 x 2 x 0,34	16,8	273,7	390	22
36120C64022A20	2 x 2 x 0,50	7,4	47,5	75	20
36120C64032A20	3 x 2 x 0,50	8,2	61,7	90	20
36120C64042A20	4 x 2 x 0,50	9,3	74,5	110	20
36120C64052A20	5 x 2 x 0,50	10,2	92,1	135	20
36120C64072A20	7 x 2 x 0,50	11	115,6	185	20
36120C64102A20	10 x 2 x 0,50	12,8	154,9	220	20
36120C64142A20	14 x 2 x 0,50	15,3	223,8	310	20
36120C64182A20	18 x 2 x 0,50	16,5	265,4	380	20
36120C64252A20	25 x 2 x 0,50	18,7	355,9	495	20
36120C64022A19	2 x 2 x 0,75	8,3	61,9	95	19
36120C64032A19	3 x 2 x 0,75	9,2	79,2	115	19
36120C64042A19	4 x 2 x 0,75	10,6	105,3	150	19
36120C64052A19	5 x 2 x 0,75	11,5	121,3	180	19
36120C64072A19	7 x 2 x 0,75	12,5	159,2	245	19
36120C64102A19	10 x 2 x 0,75	14,8	232,4	315	19
36120C64142A19	14 x 2 x 0,75	17,4	313,8	425	19
36120C64182A19	18 x 2 x 0,75	18,8	375,4	525	19
36120C64252A19	25 x 2 x 0,75	22	484,6	695	19

Other dimension and colours available on request.

TRACK CABLES

FLEXIDRUM® T 100

Continuously flexible single conductor, 0,6/1 kV



ELETTROTEK KABEL® FLEXIDRUM® T 100



Construction:

Conductor:	flexible red copper conductor Cl. 6, acc to IEC 60228, DIN VDE 0295
Insulation:	special TPE compound
Colour cores:	black
Wrapping:	non woven tape
Outer sheath:	black (RAL 9005), special PUR compound

Resistance:



Self-extinguishing and flame retardant acc. to:
DIN VDE 0482 part 265-2-1
EN 50265-2-1
IEC 60332-1-2



Oil resistance acc. to:
TMPU acc. to DIN VDE 0473 part 811-2-1,
EN 60811-2-1,
IEC 60811-2-1



Halogen free acc. to:
DIN VDE 0482 part 267,
EN 50267-2-1,
IEC 60754-1

Technical data:

Nominal voltage:	U ₀ /U 0,6/1 kV
Test voltage:	4 kV EN 50289-1-3
Temperature range	
<i>Fixed laying:</i>	- 50°C up to +90°C
<i>Flexible installation:</i>	- 40°C up to +90°C
Radiation resistance:	5 x 10 ⁷ cj/kg
Min. bending radius	
<i>Continuously flexible:</i>	7,5 x d
Max pulling force:	
<i>Static:</i>	50 N/mm ²
<i>Dinamic:</i>	20 N/mm ²
Max speed (main application):	250 m/min

Features:

highly flexible single conductor
for use in cable tracks
high abrasion resistance
UV resistant
good against acids, alkalines, solvents, hydraulic liquids etc
for SPEEDS and MINIMUM BENDING RADIUS
see pages from 2 to 8 of catalogue
RoHS and CE approval



Part no.	No. of cores x cross section n x mm ²	Outer-Ø ca. mm ± 10%	Copper weight kg/km	Cable weight approx. kg/km	AWG no. *)
04010G7L010M15	1 x 1,5	5,6	14,4	45	16
04010G7L010M25	1 x 2,5	6,5	24	63	14
04010G7L010M40	1 x 4	7,3	38,4	86	12
04010G7L010M60	1 x 6	8	57,6	114	10
04010G7L010M61	1 x 10	8,7	96	149	8
04010G7L010M62	1 x 16	10,3	153,6	210	6
04010G7L010M63	1 x 25	11,9	240	310	4
04010G7L010M64	1 x 35	13,7	336	420	2
04010G7L010M65	1 x 50	16,1	480	625	1
04010G7L010M66	1 x 70	18,1	672	854	2/0
04010G7L010M67	1 x 95	21	912	1140	3/0
04010G7L010M68	1 x 120	22,8	1152	1394	4/0
04010G7L010M69	1 x 150	24,6	1440	1716	250 MCM
04010G7L010M70	1 x 185	26,7	1776	2077	350 MCM
04010G7L010M71	1 x 240	31,5	2304	2750	450 MCM
04010G7L010M72	1 x 300	34,3	2880	3389	600 MCM

Other dimension and colours available on request.

TRACK CABLES

FLEXIDRUM® T 100 C

Continuously flexible single conductor with overall copper screen, 0,6/1 kV



ELETTROTEK KABEL® FLEXIDRUM® T 100 C



Construction:

Conductor:	flexible red copper conductor Cl. 6, acc to IEC 60228, DIN VDE 0295
Insulation:	special TPE compound
Colour cores:	black
Screen:	tinned copper braid
Wrapping:	non woven tape
Outer sheath:	black (RAL 9005), special PUR compound

Resistance:



Self-extinguishing and flame retardant acc. to:
DIN VDE 0482 part 265-2-1
EN 50265-2-1
IEC 60332-1-2



Oil resistance acc. to:
TMPU acc. to DIN VDE 0473 part 811-2-1,
EN 60811-2-1,
IEC 60811-2-1



Halogen free acc. to:
DIN VDE 0482 part 267,
EN 50267-2-1,
IEC 60754-1

Technical data:

Nominal voltage:	Uo/U 0,6/1 kV
Test voltage:	4 kV EN 50289-1-3
Temperature range	
<i>Fixed laying:</i>	- 50°C up to +90°C
<i>Flexible installation:</i>	- 40°C up to +90°C
Radiation resistance:	5 x 10 ⁷ cj/kg
Min. bending radius	
<i>Continuously flexible:</i>	7,5 x d
Max pulling force:	
<i>Static:</i>	50 N/mm ²
<i>Dinamic:</i>	20 N/mm ²
Max speed (main application):	250 m/min

Features:

highly flexible single conductor for use in cable tracks

high abrasion resistance

UV resistant

good against acids, alkalines, solvents, hydraulic liquids etc

for SPEEDS and MINIMUM BENDING RADIUS see pages from 2 to 8 of catalogue

RoHS and CE approval



Part no.	No. of cores x cross section n x mm ²	Outer-Ø ca. mm ± 10%	Copper weight kg/km	Cable weight approx. kg/km	AWG no. *)
04020G7L010M61	1 x 10	9,8	125,1	173	8
04020G7L010M62	1 x 16	11	185,7	245	6
04020G7L010M63	1 x 25	12,7	269,6	353	4
04020G7L010M64	1 x 35	14,5	407,6	480	2
04020G7L010M65	1 x 50	17	599,2	660	1
04020G7L010M66	1 x 70	18,8	805,4	980	2/0
04020G7L010M67	1 x 95	22,6	1086,2	1290	3/0
04020G7L010M68	1 x 120	23,9	1316,8	1530	4/0
04020G7L010M69	1 x 150	26,7	1647	1910	250 MCM
04020G7L010M70	1 x 185	29,2	1953,4	2250	350 MCM

Other dimension and colours available on request.

TRACK CABLES

FLEXIDRUM® T 100 UL

Continuously flexible single conductor, 0,6/1 kV, UL/CSA 1000V



ELETTROTEK KABEL® FLEXIDRUM® T 100 UL
UL style 10553 AWM I/II A/B 80°C 1000V FT1



Construction:

Conductor:	flexible red copper conductor Cl. 6, acc to IEC 60228, UL 758
Insulation:	special TPE compound
Colour cores:	black
Wrapping:	non woven tape
Outer sheath:	black (RAL 9005), special PUR compound

Resistance:



Self-extinguishing and flame retardant acc. to:

DIN VDE 0482 part 265-2-1
EN 50265-2-1
IEC 60332-1-2
UL 1581 VW-1, CSA FT-1



Oil resistance acc. to:

TMPU acc. to DIN VDE 0473 part 811-2-1,
EN 60811-2-1,
IEC 60811-2-1



Halogen free acc. to:

DIN VDE 0482 part 267,
EN 50267-2-1,
IEC 60754-1

Technical data:

Nominal voltage:	U ₀ /U 0,6/1 kV	
UL/CSA:	1000 V	
Test voltage:	4 kV EN 50289-1-3	
Temperature range	DIN VDE:	UL/CSA:
<i>Fixed laying:</i>	-50°C up to +90°C	up to +80°C
<i>Flexible installation:</i>	-40°C up to +90°C	
Radiation resistance:	5 x 10 ⁻⁷ cJ/kg	
Min. bending radius		
<i>Continuously flexible:</i>	7,5 x d	
Max pulling force:		
<i>Static:</i>	50 N/mm ²	
<i>Dinamic:</i>	20 N/mm ²	
Max speed (main application):	250m/min	

Features:

highly flexible single conductor
for use in cable tracks

good against acids, alkalines, solvents, hydraulic liquids etc

high abrasion resistance

UV resistant

AWM style 10553 AWM I/II A/B 80°C 1000V FT1
test voltage acc. to EN 50289-1-3
conductor resistance at 20°C acc. to EN 50289-1-2

for SPEEDS and MINIMUM BENDING RADIUS
see pages from 2 to 8 of catalogue

RoHS and CE approval



Part no.	No. of cores x cross section n x mm ²	Outer-Ø ca. mm ± 10%	Copper weight kg/km	Cable weight approx. kg/km	AWG no. *)
04030H7L010A16	1x1,5	5,6	14,4	45	16
04030H7L010A14	1x2,5	6,5	24	63	14
04030H7L010A12	1x4	7,3	38,4	85	12
04030H7L010A10	1x6	8	57,6	114	10
04030H7L010A08	1x10	9,8	96	173	8
04030H7L010A06	1x16	10,8	153,6	245	6
04030H7L010A04	1x25	12,7	240	353	4
04030H7L010A02	1x35	14	336	459	2
04030H7L010A01	1x50	16,1	480	638	1
04030H7L010A2C	1x70	18,1	672	854	2/0
04030H7L010A3C	1x95	21	912	1140	3/0
04030H7L010A4C	1x120	22,8	1152	1394	4/0
04030H7L010A5C	1x150	24,6	1440	1716	250 MCM
04030H7L010A7C	1x185	26,7	1776	2077	350 MCM
04030H7L010A9C	1x240	31,5	2304	2750	450 MCM
04030H7L010ACC	1x300	34,3	2880	3389	600 MCM

Other dimension and colours available on request.

TRACK CABLES

FLEXIDRUM® T 100 C UL

Continuously flexible single conductor with overall copper screen, 0,6/1 kV, UL/CSA 1000V



ELETTROTEK KABEL® FLEXIDRUM® T 100 C UL
UL style 10553 AWM I/II A/B 80°C 1000V FT1

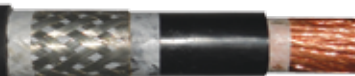

Construction:

Conductor:	flexible red copper conductor Cl. 6, acc to IEC 60228, UL 758
Insulation:	special TPE compound
Colour cores:	black
Screen:	tinned copper braid acc.to UL 1569
Wrapping:	non woven tape
Outer sheath:	black (RAL 9005), special PUR compound

Resistance:



Self-extinguishing and flame retardant acc. to:

DIN VDE 0482 part 265-2-1
EN 50265-2-1
IEC 60332-1-2
UL 1581 VW-1, CSA FT-1



Oil resistance acc. to:

TMPU acc. to DIN VDE 0473 part 811-2-1,
EN 60811-2-1,
IEC 60811-2-1



Halogen free acc. to:

DIN VDE 0482 part 267,
EN 50267-2-1,
IEC 60754-1

Technical data:

Nominal voltage:	U ₀ /U 0,6/1 kV
UL/CSA:	1000 V
Test voltage:	4 kV EN 50289-1-3
Temperature range	DIN VDE: -50°C up to +90°C
<i>Fixed laying:</i>	up to +80°C
<i>Flexible installation:</i>	-40°C up to +90°C
Radiation resistance:	5 x 10 ⁷ cJ/kg
Min. bending radius	
<i>Continuously flexible:</i>	7,5 x d (other min. bending radius on request)
Max pulling force:	
<i>Static:</i>	50 N/mm ²
<i>Dinamic:</i>	20 N/mm ²
Max speed (main application):	250 m/min

Features:

highly flexible single conductor
for use in cable tracks
good against acids, alkalines, solvents, hydraulic liquids etc
high abrasion resistance
UV resistant
AWM style 10553 AWM I/II A/B 80°C 1000V FT1
test voltage acc. to EN 50289-1-3
conductor resistance at 20°C acc. to EN 50289-1-2
for SPEEDS and MINIMUM BENDING RADIUS
see pages from 2 to 8 of catalogue
RoHS and CE approval



Part no.	No. of cores x cross section n x mm ²	Outer-Ø ca. mm ± 10%	Copper weight kg/km	Cable weight approx. kg/km	AWG no. *)
04040H7L010A10	1x6	8,5	77	120	10
04040H7L010A08	1x10	10,5	127	170	8
04040H7L010A06	1x16	11,8	189	236	6
04040H7L010A04	1x25	13,5	285	341	4
04040H7L010A02	1x35	15	389	447	2
04040H7L010A01	1x50	17,5	544	613	1
04040H7L010A2C	1x70	19,5	768	837	2/0
04040H7L010A3C	1x95	23	1020	1096	3/0
04040H7L010A4C	1x120	24,5	1265	1331	4/0
04040H7L010A5C	1x150	27,5	1450	1578	250 MCM
04040H7L010A7C	1x185	30	2040	2166	350 MCM
04040H7L010A9C	1x240	32	2621	2791	450 MCM
04040H7L010ACC	1x300	33	-	3130	600 MCM

Other dimension and colours available on request.

TRACK CABLES

FLEXIDRUM® T 101

Continuously flexible single conductor, 0,6/1 kV



ELETTROTEK KABEL® FLEXIDRUM® T 101



Construction:

Conductor:	flexible red copper conductor Cl. 6, acc to IEC 60228, DIN VDE 0295
Insulation:	special TPE compound
Colour cores:	green/yellow
Wrapping:	non woven tape
Outer sheath:	black (RAL 9005), special PUR compound

Resistance:



Self-extinguishing and flame retardant acc. to:
DIN VDE 0482 part 265-2-1
EN 50265-2-1
IEC 60332-1-2



Oil resistance acc. to:
TMPU acc. to DIN VDE 0473 part 811-2-1,
EN 60811-2-1,
IEC 60811-2-1



Halogen free acc. to:
DIN VDE 0482 part 267,
EN 50267-2-1,
IEC 60754-1

Technical data:

Nominal voltage:	U ₀ /U 0,6/1 kV
Test voltage:	4 kV EN 50289-1-3
Temperature range	
<i>Fixed laying:</i>	- 50°C up to +90°C
<i>Flexible installation:</i>	- 40°C up to +90°C
Radiation resistance:	5 x 10 ⁷ cj/kg
Min. bending radius	
<i>Continuously flexible:</i>	7,5 x d
Max pulling force:	
<i>Static:</i>	50 N/mm ²
<i>Dinamic:</i>	20 N/mm ²
Max speed (main application):	250 m/min

Features:

highly flexible single conductor
for use in cable tracks

good chemical resistance

good against acids, alkalines, solvents, hydraulic liquids etc

high abrasion resistance

UV resistant

for SPEEDS and MINIMUM BENDING RADIUS
see pages from 2 to 8 of catalogue

RoHS and CE approval



Part no.	No. of cores x cross section n x mm ²	Outer-Ø ca. mm ± 10%	Copper weight kg/km	Cable weight approx. kg/km	AWG no. *)
04050G7P011M15	1G1,5	5,6	14,4	45	16
04050G7P011M25	1G2,5	6,5	24	63	14
04050G7P011M40	1G4	7,3	38,4	86	12
04050G7P011M60	1G6	8,0	57,6	114	10
04050G7P011M61	1G10	8,7	96	149	8
04050G7P011M62	1G16	10,3	153,6	210	6
04050G7P011M63	1G25	11,9	240	310	4
04050G7P011M64	1G35	13,7	336	420	2
04050G7P011M65	1G50	16,1	480	625	1
04050G7P011M66	1G70	18,1	672	854	2/0
04050G7P011M67	1G95	21	912	1140	3/0
04050G7P011M68	1G120	22,8	1152	1394	4/0
04050G7P011M69	1G150	24,6	1440	1716	250 MCM
04050G7P011M70	1G185	26,7	1776	2077	350 MCM
04050G7P011M71	1G240	31,5	2304	2750	450 MCM
04050G7P011M72	1G300	34,3	2880	3389	600 MCM

Other dimension and colours available on request.

TRACK CABLES

FLEXIDRUM® T 101 C

Continuously flexible single conductor with overall copper screen, 0,6/1 kV



ELETTROTEK KABEL® FLEXIDRUM® T 101 C



Construction:

Conductor:	flexible red copper conductor Cl. 6, acc to IEC 60228, DIN VDE 0295
Insulation:	special TPE compound
Colour cores:	green/yellow
Screen:	tinned copper braid
Wrapping:	non woven tape
Outer sheath:	black (RAL 9005), special PUR compound

Resistance:



Self-extinguishing and flame retardant acc. to:
DIN VDE 0482 part 265-2-1
EN 50265-2-1
IEC 60332-1-2



Oil resistance:
TMPU acc. to DIN VDE 0473 part 811-2-1,
EN 60811-2-1,
IEC 60811-2-1



Halogen free acc. to:
DIN VDE 0482 part 267,
EN 50267-2-1,
IEC 60754-1

Technical data:

Nominal voltage:	Uo/U 0,6/1 kV
Test voltage:	4 kV EN 50289-1-3
Temperature range	
<i>Fixed laying:</i>	- 50°C up to +90°C
<i>Flexible installation:</i>	- 40°C up to +90°C
Radiation resistance:	5 x 10 ⁷ cj/kg
Min. bending radius	
<i>Continuously flexible:</i>	7,5 x d
Max pulling force:	
<i>Static:</i>	50 N/mm ²
<i>Dinamic:</i>	20 N/mm ²
Max speed (main application):	250 m/min

Features:

highly flexible single conductor for use in cable tracks
good chemical resistance
good against acids, alkalines, solvents, hydraulic liquids etc
high abrasion resistance
UV resistant
for SPEEDS and MINIMUM BENDING RADIUS see pages from 2 to 8 of catalogue

RoHS and CE approval



Part no.	No. of cores x cross section n x mm ²	Outer-Ø ca. mm ± 10%	Copper weight kg/km	Cable weight approx. kg/km	AWG no.*)
04060G7P011M61	1G10	9,8	125,1	173	8
04060G7P011M62	1G16	11	185,7	245	6
04060G7P011M63	1G25	12,7	269,6	353	4
04060G7P011M64	1G35	14,5	407,6	480	2
04060G7P011M65	1G50	17	599,2	660	1
04060G7P011M66	1G70	18,8	805,4	980	2/0
04060G7P011M67	1G95	22,6	1086,2	1290	3/0
04060G7P011M68	1G120	23,9	1316,8	1530	4/0
04060G7P011M69	1G150	26,7	1647	1910	250 MCM
04060G7P011M70	1G185	29,2	1953,4	2250	350 MCM

Other dimension and colours available on request.

TRACK CABLES

FLEXIDRUM® T 101 UL

Continuously flexible single conductor, 0,6/1 kV, UL/CSA 1000V



ELETTROTEK KABEL® FLEXIDRUM® T 101 UL
UL style 10553 AWM I/II A/B 80°C 1000V FT1



Construction:

Conductor:	flexible red copper conductor Cl. 6, acc to IEC 60228, DIN VDE 0295
Insulation:	special TPE compound
Colour cores:	green/yellow
Wrapping:	non woven tape
Outer sheath:	black (RAL 9005), special PUR compound

Resistance:



Self-extinguishing and flame retardant acc. to:

DIN VDE 0482 part 265-2-1
EN 50265-2-1
IEC 60332-1-2
UL 1581 VW-1, CSA FT-1



Oil resistance:

TMPU acc. to DIN VDE 0473 part 811-2-1,
EN 60811-2-1,
IEC 60811-2-1



Halogen free acc. to:

DIN VDE 0482 part 267,
EN 50267-2-1,
IEC 60754-1

Technical data:

Nominal voltage:	U ₀ /U 0,6/1 kV	
UL/CSA:	1000 V	
Test voltage:	4 kV EN 50289-1-3	
Temperature range	DIN VDE:	UL/CSA:
<i>Fixed laying:</i>	-50°C up to +90°C	up to +80°C
<i>Flexible installation:</i>	-40°C up to +90°C	
Radiation resistance:	5 x 10 ⁷ cj/kg	
Min. bending radius		
<i>Continuously flexible:</i>	7,5 x d	
Max pulling force:		
<i>Static:</i>	50 N/mm ²	
<i>Dinamic:</i>	20 N/mm ²	
Max speed (main application):	250 m/min	

Features:

highly flexible single conductor
for use in cable tracks

good chemical resistance

good against acids, alkalines, solvents, hydraulic liquids etc

high abrasion resistance

UV resistant

AWM style 10553 AWM I/II A/B 80°C 1000V FT1
test voltage acc. to EN 50289-1-3
conductor resistance at 20°C acc. to EN 50289-1-2

for SPEEDS and MINIMUM BENDING RADIUS
see pages from 2 to 8 of catalogue

RoHS and CE approval



Part no.	No. of cores x cross section n x mm ²	Outer-Ø ca. mm ± 10%	Copper weight kg/km	Cable weight approx. kg/km	AWG no. *)
04070H7P011A16	1G1,5	5,6	14,4	45	16
04070H7P011A14	1G2,5	6,5	24	63	14
04070H7P011A12	1G4	7,3	38,4	86	12
04070H7P011A10	1G6	8,0	57,6	114	10
04070H7P011A08	1G10	8,7	96	149	8
04070H7P011A06	1G16	10,3	153,6	210	6
04070H7P011A04	1G25	11,9	240	310	4
04070H7P011A02	1G35	13,7	336	420	2
04070H7P011A01	1G50	16,1	480	625	1
04070H7P011A2C	1G70	18,1	672	854	2/0
04070H7P011A3C	1G95	21	912	1140	3/0
04070H7P011A4C	1G120	22,8	1152	1394	4/0
04070H7P011A5C	1G150	24,6	1440	1716	250 MCM
04070H7P011A7C	1G185	26,7	1776	2077	350 MCM
04070H7P011A9C	1G240	31,5	2304	2750	450 MCM
04070H7P011ACC	1G300	34,3	2880	3389	600 MCM

Other dimension and colours available on request.

TRACK CABLES

FLEXIDRUM® T 101 C UL

Continuously flexible single conductor with overall copper screen, 0,6/1 kV, UL/CSA 1000V



ELETTROTEK KABEL® FLEXIDRUM® T 101 C UL
UL style 10553 AWM I/II A/B 80°C 1000V FT1

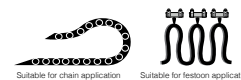

Construction:

Conductor:	flexible red copper conductor Cl. 6, acc to IEC 60228, DIN VDE 0295
Insulation:	special TPE compound
Colour cores:	green/yellow
Screen:	tinned copper braid
Wrapping:	non woven tape
Outer sheath:	black (RAL 9005), special PUR compound

Resistance:



Self-extinguishing and flame retardant acc. to:

DIN VDE 0482 part 265-2-1
EN 50265-2-1
IEC 60332-1-2
UL 1581 VW-1, CSA FT-1



Oil resistance:

TMPU acc. to DIN VDE 0473 part 811-2-1,
EN 60811-2-1,
IEC 60811-2-1



Halogen free acc. to:

DIN VDE 0482 part 267,
EN 50267-2-1,
IEC 60754-1

Technical data:

Nominal voltage:	U ₀ /U 0,6/1 kV	
UL/CSA:	1000 V	
Test voltage:	4 kV EN 50289-1-3	
Temperature range	DIN VDE:	UL/CSA:
<i>Fixed laying:</i>	-50°C up to +90°C	up to +80°C
<i>Flexible installation:</i>	-40°C up to +90°C	
Radiation resistance:	5 x 10 ⁷ cj/kg	
Min. bending radius		
<i>Continuously flexible:</i>	7,5 x d	
Max pulling force:		
<i>Static:</i>	50 N/mm ²	
<i>Dinamic:</i>	20 N/mm ²	
Max speed (main application):	250 m/min	

Features:

highly flexible single conductor
for use in cable tracks

good chemical resistance

good against acids, alkalines, solvents, hydraulic liquids etc

high abrasion resistance

UV resistant

AWM style 10553 AWM I/II A/B 80°C 1000V FT1
test voltage acc. to EN 50289-1-3
conductor resistance at 20°C acc. to EN 50289-1-2

for SPEEDS and MINIMUM BENDING RADIUS
see pages from 2 to 8 of catalogue

RoHS and CE approval



Part no.	No. of cores x cross section n x mm ²	Outer-Ø ca. mm ± 10%	Copper weight kg/km	Cable weight approx. kg/km	AWG no. *)
04080H7P011A10	1G6	8,5	77	120	10
04080H7P011A08	1G10	10,5	127	170	8
04080H7P011A06	1G16	11,8	189	236	6
04080H7P011A04	1G25	13,5	285	341	4
04080H7P011A02	1G35	15	389	447	2
04080H7P011A01	1G50	17,5	544	613	1
04080H7P011A2C	1G70	19,5	768	837	2/0
04080H7P011A3C	1G95	23	1020	1096	3/0
04080H7P011A4C	1G120	24,5	1265	1331	4/0
04080H7P011A5C	1G150	27,5	1450	1578	250 MCM
04080H7P011A7C	1G185	30	2040	2166	350 MCM
04080H7P011A9C	1G240	32	2621	2791	450 MCM
04080H7P011ACC	1G300	33	-	3130	600 MCM

Other dimension and colours available on request.

TRACK CABLES

FLEXIDRUM® TD 200

Extremely flexible TPE/PUR data cable with colored cores, max. 350V



ELETTROTEK KABEL® FLEXIDRUM® TD 200



Construction:

Conductor:	flexible red copper conductor Cl. 6, acc to IEC 60228, DIN VDE 0295
Insulation:	special TPE compound
Colour cores:	acc. to DIN 47100
Stranding:	in layers
Wrapping:	non woven tape over each layer
Outer sheath:	grey (RAL 7032), PUR type TMPU, acc. to DIN VDE 0282 part 10 + HD 21.1

Resistance:



Oil resistance:

very good TMPU acc.to DIN VDE 0282 part 10 + HD 22.10, DIN VDE 0473 part 811-2-1 IEC EN 60811-2-1



Halogen free acc. to:

DIN VDE 0482 part 267, EN 50267-2-1, IEC 60754-1

Technical data:

Nominal voltage:	DIN VDE: max. 350 V
Test voltage:	1,5 kV acc. to DIN VDE 0472 part 509
Temperature range	
<i>Fixed laying:</i>	-50°C up to +90°C
<i>Flexible installation:</i>	-40°C up to +90°C
Radiation resistance:	5 x 10 ⁷ cj/kg
Min. bending radius	
<i>Continuously flexible:</i>	5 x d
Max speed (main application):	250 m/min

Features:

lacks uncritical (lacks= enamel moistening interfering substances)

flexible at low temperatures

continuously flexible

high abrasion resistance

weather resistance

min.bending radius

small outer diameter

with mat surface outer sheath

travel > 10 m is possible

good against acids,alkalines,solvents,hydraulic liquids etc.

for SPEEDS and MINIMUM BENDING RADIUS see pages from 2 to 8 of catalogue

RoHS and CE approval



TRACK CABLES

FLEXIDRUM® TD 200

Extremely flexible TPE/PUR data cable with colored cores, max. 350V



ELETTROTEK KABEL® FLEXIDRUM® TD 200



Part no.	No. of cores x cross section n x mm ²	Outer-Ø ca. mm ± 10%	Copper weight kg/km	Cable weight approx. kg/km	AWG no. *)
36320C64020M01	2 x 0,14	3,2	2,7	11	26
36320C64030M01	3 x 0,14	3,3	4,0	13	26
36320C64040M01	4 x 0,14	3,6	5,4	15	26
36320C64050M01	5 x 0,14	3,8	6,7	18	26
36320C64070M01	7 x 0,14	4,4	9,4	24	26
36320C64100M01	10 x 0,14	5,1	13,4	30	26
36320C64120M01	12 x 0,14	5,2	16,1	34	26
36320C64140M01	14 x 0,14	5,5	18,8	38	26
36320C64180M01	18 x 0,14	6	24,2	48	26
36320C64250M01	25 x 0,14	7,1	33,6	63	26
36320C64320M01	32 x 0,14	7,6	43	78	26
36320C64020M02	2 x 0,25	3,5	4,8	15	24
36320C64030M02	3 x 0,25	3,7	7,2	18	24
36320C64040M02	4 x 0,25	3,9	9,6	21	24
36320C64050M02	5 x 0,25	4,2	12	25	24
36320C64070M02	7 x 0,25	4,9	16,8	34	24
36320C64100M02	10 x 0,25	5,7	24	43	24
36320C64120M02	12 x 0,25	5,8	28,8	49	24
36320C64140M02	14 x 0,25	6,1	33,6	56	24
36320C64180M02	18 x 0,25	6,8	43,2	71	24
36320C64250M02	25 x 0,25	8,1	60,0	94	24
36320C64320M02	32 x 0,25	8,8	76,8	120	24
36320C64020M03	2 x 0,34	3,7	6,5	17	22
36320C64030M03	3 x 0,34	3,9	9,8	21	22
36320C64040M03	4 x 0,34	4,2	13,1	25	22
36320C64050M03	5 x 0,34	4,5	16,3	30	22
36320C64070M03	7 x 0,34	5,2	22,8	41	22
36320C64100M03	10 x 0,34	6,1	32,6	52	22
36320C64120M03	12 x 0,34	6,3	39,2	60	22
36320C64140M03	14 x 0,34	6,6	45,7	69	22
36320C64180M03	18 x 0,34	7,3	58,8	87	22
36320C64250M03	25 x 0,34	8,9	81,6	119	22
36320C64320M03	32 x 0,34	9,5	104,4	149	22

Other dimension and colours available on request.

TRACK CABLES

FLEXIDRUM® T 200

Extremely flexible TPE/PUR control cable, 300/500 V

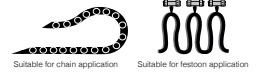

Construction:

Conductor:	flexible red copper conductor Cl. 6, acc. to IEC 60228, DIN VDE 0295
Insulation:	special TPE compound
Colour cores:	black cores with consecutive numbers acc. to EN 50334, green-yellow from 3 cores
Stranding:	in layers
Wrapping:	non woven tape over each layer
Outer sheath:	grey (RAL 7000), PUR compound acc. to UL 1581

Resistance:



Oil resistance:
very good TPU acc. to DIN VDE 0282 part 10 + HD 22.10, DIN VDE 0473 part 811-2-1 IEC EN 60811-2-1



Halogen free acc. to:
DIN VDE 0482 part 267, EN 50267-2-1, IEC 60754-1

Technical data:

Nominal voltage:	U ₀ /U 300/500 V
Test voltage:	2 kV
Temperature range	
<i>Fixed laying:</i>	-50°C up to +90°C
<i>Flexible installation:</i>	-40°C up to +90°C
Radiation resistance:	5 x 10 ⁻⁷ cJ/kg
Min. bending radius	
<i>Continuously flexible:</i>	5 x d
Max speed (main application):	250 m/min

Features:

- labs uncritical (labs=enamel moisturing interfering substances)
- very flexible at low temperatures
- continuously flexible
- halogen-free
- weather resistance
- high abrasion resistance
- high mechanical resistance
- small min.bending radius
- small outer diameter
- with mat surface outer sheath
- travel > 10 m is possible
- good against acids,alkalines,solvents,hydraulic liquids etc.
- high weather resistance
- for SPEEDS and MINIMUM BENDING RADIUS see pages from 2 to 8 of catalogue
- RoHS and CE approval



TRACK CABLES

FLEXIDRUM® T 200

Extremely flexible TPE/PUR control cable, 300/500 V



ELETTROTEK KABEL® FLEXIDRUM® T 200



Part no.	No. of cores x cross section n x mm ²	Outer-Ø ca. mm ± 10%	Copper weight kg/km	Cable weight approx. kg/km	AWG no. *)
04090D41020M05	2 x 0,5	4,9	9,6	27	20
04090D40031M05	3 G 0,5	5,1	14,4	34	20
04090D40041M05	4 G 0,5	5,5	19,2	41	20
04090D40051M05	5 G 0,5	6	24	50	20
04090D40071M05	7 G 0,5	6,9	33,6	67	20
04090D40121M05	12 G 0,5	8,3	57,6	98	20
04090D40181M05	18 G 0,5	9,9	86,4	145	20
04090D40251M05	25 G 0,5	11,9	120	196	20
04090D40361M05	36 G 0,5	13,7	172,8	280	20
04090D40501M05	50 G 0,5	16,1	240	379	20
04090D40651M05	65 G 0,5	18,2	312	492	20
04090D41020M07	2 x 0,75	5,4	14,4	35	19
04090D40031M07	3 G 0,75	5,7	21,6	45	19
04090D40041M07	4 G 0,75	6,1	28,8	54	19
04090D40051M07	5 G 0,75	6,7	36	66	19
04090D40071M07	7 G 0,75	7,7	50,4	90	19
04090D40121M07	12 G 0,75	9,6	86,4	137	19
04090D40181M07	18 G 0,75	11,3	129,6	201	19
04090D40251M07	25 G 0,75	13,9	180	277	19
04090D40361M07	36 G 0,75	15,4	259,2	382	19
04090D40501M07	50 G 0,75	18,4	360	526	19
04090D40651M07	65 G 0,75	20,8	468	683	19
04090D41020M10	2 x 1	5,8	19,2	43	18
04090D40031M10	3 G 1	6,1	28,8	55	18
04090D40041M10	4 G 1	6,6	38,4	67	18
04090D40051M10	5 G 1	7,2	48	83	18
04090D40071M10	7 G 1	8,4	67,2	114	18
04090D40121M10	12 G 1	10,4	115,2	173	18
04090D40181M10	18 G 1	12,3	172,8	256	18
04090D40251M10	25 G 1	15,1	240	353	18
04090D40361M10	36 G 1	17	345,6	497	18
04090D40501M10	50 G 1	20	480	682	18
04090D40651M10	65 G 1	23	624	886	18
04090D41020M15	2 x 1,5	6,4	28,2	55	18
04090D40031M15	3 G 1,5	6,7	43,2	73	18
04090D40041M15	4 G 1,5	7,3	57,6	91	18
04090D40051M15	5 G 1,5	8	72	112	18
04090D40071M15	7 G 1,5	9,6	100,8	157	18
04090D40121M15	12 G 1,5	11,9	172,8	243	18
04090D40181M15	18 G 1,5	14,2	259,2	364	18
04090D40251M15	25 G 1,5	17,1	360	493	18
04090D40361M15	36 G 1,5	19,2	518,4	695	18
04090D40501M15	50 G 1,5	23	720	955	18
04090D40651M15	65 G 1,5	26	936	1241	18
04090D41010M25	1 x 2,5	4,6	24	37	14
04090D41020M25	2 x 2,5	8	48	86	14
04090D40031M25	3 G 2,5	8,5	72	116	14
04090D40041M25	4 G 2,5	9,4	96	147	14
04090D40051M25	5 G 2,5	10,4	120	182	14
04090D40071M25	7 G 2,5	12,4	168	255	14
04090D40121M25	12 G 2,5	15,8	288	405	14
04090D40181M25	18 G 2,5	18,6	432	596	14
04090D40251M25	25 G 2,5	22,7	600	814	14
04090D40361M25	36 G 2,5	25,5	864	1146	14
04090D41010M40	1 x 4	5,4	38,4	54	12
04090D41020M40	2 x 4	9,3	76,8	127	12
04090D40031M40	3 G 4	9,8	115,2	169	12
04090D40041M40	4 G 4	10,8	153,6	210	12
04090D40051M40	5 G 4	12,1	192	272	12
04090D40071M40	7 G 4	14,6	268,8	389	12

TRACK CABLES

FLEXIDRUM® T 200

Extremely flexible TPE/PUR control cable, 300/500 V

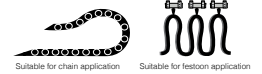

Part no.	No. of cores x cross section n x mm ²	Outer-Ø ca. mm ± 10%	Copper weight kg/km	Cable weight approx. kg/km	AWG no. *)
04090D41010M60	1 x 6	6,1	57,6	76	10
04090D41020M60	2 x 6	10,8	115,2	183	10
04090D40031M60	3 G 6	11,7	172,8	246	10
04090D40041M60	4 G 6	12,8	230,4	310	10
04090D40051M60	5 G 6	14,5	288	400	10
04090D40071M60	7 G 6	17,3	403,2	561	10
04090D41010M61	1 x 10	7,1	96	117	8
04090D40031M61	3 G 10	14,5	288	407	8
04090D40041M61	4 G 10	15,8	384	506	8
04090D40051M61	5 G 10	17,2	480	627	8
04090D41010M62	1 x 16	8,3	153,6	177	6
04090D40031M62	3 G 16	17,2	460,8	604	6
04090D40041M62	4 G 16	19	614,4	780	6
04090D40051M62	5 G 16	21,2	768	978	6
04090D41010M63	1 x 25	9,9	240	270	4
04090D40031M63	3 G 25	20,6	720	920	4
04090D40041M63	4 G 25	22,8	960	1182	4
04090D40051M63	5 G 25	25,4	1200	1485	4
04090D41010M64	1 x 35	11,5	336	362	2
04090D40041M64	4 G 35	26,4	1344	1598	2
04090D40051M64	5 G 35	29,4	1680	2010	2
04090D41010M65	1 x 50	14	480	531	1
04090D40041M65	4 G 50	31,8	1920	2259	1
04090D41010M66	1 x 70	16,7	672	744	2/0
04090D41010M67	1 x 95	20,5	912	1020	3/0
04090D41010M68	1 x 120	21,5	1152	1244	4/0
04090D41010M69	1 x 150	24,6	1440	1584	250 MCM
04090D41010M70	1 x 185	26,7	1776	1920	350 MCM
04090D41010M71	1 x 240	30,1	2304	2458	450 MCM

Other dimension and colours available on request.

TRACK CABLES

FLEXIDRUM® TD 200 C

Continuously flexible TPE/PUR data cable with colored cores and overall copper screen, max. 350 V



ELETTROTEK KABEL® FLEXIDRUM® TD 200 C



Construction:

Conductor:	flexible red copper conductor Cl. 6, acc to IEC 60228, DIN VDE 0295
Insulation:	special TPE compound
Colour cores:	acc. to DIN 47100
Stranding:	in layers
Wrapping:	non woven tape over each layer
Screen:	tinned copper braid
Wrapping:	non woven tape
Outer sheath:	grey (RAL 7032), PUR type TMPU, acc. to DIN VDE 0282 part 10 + HD 21.1

Resistance:



Oil resistance:
very good TMPU acc.to DIN VDE 0282 part 10 + HD 22.10,
DIN VDE 0473 part 811-2-1
IEC EN 60811-2-1



Halogen free acc. to:
DIN VDE 0482 part 267,
EN 50267-2-1,
IEC 60754-1

Technical data:

Nominal voltage:	DIN VDE: max. 350 V
Test voltage:	1,5 kV acc. to DIN VDE 0472 part 509 core/screen 1,2 kV
Temperature range	
<i>Fixed laying:</i>	-50°C up to +90°C
<i>Flexible installation:</i>	-40°C up to +90°C
Radiation resistance:	5 x 10 ⁷ cJ/kg
Min. bending radius	
<i>Continuously flexible:</i>	7,5 x d
Max speed (main application):	250 m/min

Features:

labs uncritical (labs=enamel moisturing interfering substances)
good EMC characteristics
flexible at low temperatures
continuously flexible
high abrasion resistance
weather resistance
small outer diameter
mat surface outer sheath
travel > 10 m is possible
good against acids,alkalines,solvents,hydraulic liquids etc.
for SPEEDS and MINIMUM BENDING RADIUS
see pages from 2 to 8 of catalogue
RoHS and CE approval



TRACK CABLES

FLEXIDRUM® TD 200 C

Continuously flexible TPE/PUR data cable with colored cores and overall copper screen, max. 350 V



ELETTROTEK KABEL® FLEXIDRUM® TD 200 C



Part no.	No. of cores x cross section n x mm ²	Outer-Ø ca. mm ± 10%	Copper weight kg/km	Cable weight approx. kg/km	AWG no.*)
36330C64020M01	2 x 0,14	3,7	13	18	26
36330C64030M01	3 x 0,14	3,8	14,3	20	26
36330C64040M01	4 x 0,14	4,1	15,7	24	26
36330C64050M01	5 x 0,14	4,3	17,1	27	26
36330C64070M01	7 x 0,14	4,9	23,4	35	26
36330C64120M01	12 x 0,14	5,9	32,1	54	26
36330C64180M01	18 x 0,14	6,7	43,8	70	26
36330C64250M01	25 x 0,14	7,8	57,3	90	26
36330C64320M01	32 x 0,14	8,5	81,2	104	26
36330C64020M02	2 x 0,25	4	15,1	23	24
36330C64030M02	3 x 0,25	4,2	17,6	26	24
36330C64040M02	4 x 0,25	4,4	23,4	29	24
36330C64050M02	5 x 0,25	4,7	25,9	35	24
36330C64070M02	7 x 0,25	5,4	32,7	46	24
36330C64120M02	12 x 0,25	6,6	48,3	71	24
36330C64180M02	18 x 0,25	7,5	64,7	95	24
36330C64250M02	25 x 0,25	9	86,3	127	24
36330C64320M02	32 x 0,25	9,5	105,9	156	24
36330C64020M03	2 x 0,34	4,2	16,9	26	22
36330C64030M03	3 x 0,34	4,4	23,6	29	22
36330C64040M03	4 x 0,34	4,7	27	35	22
36330C64050M03	5 x 0,34	5	29,7	41	22
36330C64070M03	7 x 0,34	5,7	38,9	53	22
36330C64120M03	12 x 0,34	6,9	58,8	82	22
36330C64180M03	18 x 0,34	8	82,5	115	22
36330C64250M03	25 x 0,34	9,6	110,7	155	22
36330C64320M03	32 x 0,34	10,2	155	185	22
36330C64020M05	2 x 0,5	4,8	23,5	34	20
36330C64030M05	3 x 0,5	5	28,4	39	20
36330C64040M05	4 x 0,5	5,4	35,1	47	20
36330C64050M05	5 x 0,5	5,8	40,1	55	20
36330C64070M05	7 x 0,5	6,9	53,5	81	20
36330C64120M05	12 x 0,5	8	81,4	105	20
36330C64180M05	18 x 0,5	9,7	115,6	167	20
36330C64250M05	25 x 0,5	11,8	176,2	222	20
36330C64020M07	2 x 0,75	5,4	30,3	44	20
36330C64030M07	3 x 0,75	5,7	37,6	52	20
36330C64040M07	4 x 0,75	6,3	46,5	69	20
36330C64050M07	5 x 0,75	6,8	54,9	81	20
36330C64070M07	7 x 0,75	7,9	74,1	106	20
36330C64120M07	12 x 0,75	9,7	115,6	163	20
36330C64180M07	18 x 0,75	11,6	181,5	227	20
36330C64250M07	25 x 0,75	14,1	248,5	316	20

Other dimension and colours available on request.

TRACK CABLES

FLEXIDRUM® T 200 C

Continuously flexible TPE/PUR control cable, inner sheath and overall copper screen,300/500 V



Construction:

Conductor:	flexible red copper conductor Cl. 6, acc to IEC 60228, DIN VDE 0295
Insulation:	special TPE compound
Colour cores:	black cores with consecutive numbers acc. to EN 50334, green-yellow from 3 cores
Stranding:	in layers
Wrapping:	non woven tape over each layer
Inner sheath:	halogen free compound
Wrapping:	non-woven tape
Screen:	tinned copper braid
Wrapping:	non-woven tape
Outer sheath:	grey (RAL 7000), PUR type TPU

Resistance:



Oil resistance:
very good TPU acc.to DIN VDE 0282 part 10 + HD 22.10, DIN VDE 0473 part 811-2-1 IEC EN 60811-2-1



Halogen free acc. to:
DIN VDE 0482 part 267, EN 50267-2-1, IEC 60754-1 (equivalent DIN VDE 0472 part 815)

Technical data:

Nominal voltage:	U ₀ /U 300/500 V
Test voltage:	2 kV
Temperature range	
<i>Fixed laying:</i>	-50°C +90°C
<i>Flexible installation:</i>	-40°C +90°C
Radiation resistance:	5 x 10 ⁷ cj/kg
Min. bending radius	
<i>Continuously flexible:</i>	7,5 x d
Max speed (main application):	250 m/min

Features:

- labs uncritical (labs=enamel moisturing interfering substances)
- good EMC characteristics
- very flexible at low temperatures
- continuously flexible
- high abrasion resistance
- high mechanical resistance
- weather resistance
- small min. bending radius
- small outer diameter
- mat surface outer sheath
- travel > 10 m is possible
- good against acids,alkalines,solvents,hydraulic liquids etc.
- for SPEEDS and MINIMUM BENDING RADIUS see pages from 2 to 8 of catalogue
- RoHS and CE approval



Part no.	No.of cores x cross section n x mm ²	Outer-Ø ca.mm ± 10%	Copper weight kg/km	Cable weight approx. kg/km	AWG no.)*
04100D41020M05	2 x 0,5	6,8	38,4	51	20
04100D40031M05	3 G 0,5	7,0	43,6	58	20
04100D40041M05	4 G 0,5	7,4	51,1	67	20
04100D40051M05	5 G 0,5	7,9	61,5	77	20
04100D40071M05	7 G 0,5	9,0	74,1	101	20
04100D40121M05	12 G 0,5	10,6	108,2	151	20
04100D40181M05	18 G 0,5	12,2	143	203	20
04100D40251M05	25 G 0,5	14,8	217	299	20
04100D40361M05	36 G 0,5	16,4	275,3	379	20
04100D40521M05	52 G 0,5	19,2	379,7	524	20
04100D40651M05	65 G 0,5	21,7	451,5	647	20

TRACK CABLES

FLEXIDRUM® T 200 C

Continuously flexible TPE/PUR control cable, inner sheath and overall copper screen,300/500 V



Part no.	No. of cores x cross section n x mm ²	Outer-Ø ca. mm ± 10%	Copper weight kg/km	Cable weight approx. kg/km	AWG no. *)
04100D41020M07	2 x 0,75	7,3	46,3	59	19
04100D40031M07	3 G 0,75	7,6	54,1	70	19
04100D40041M07	4 G 0,75	8	64	82	19
04100D40051M07	5 G 0,75	8,8	74,3	98	19
04100D40071M07	7 G 0,75	9,8	92,3	123	19
04100D40121M07	12 G 0,75	11,9	142,4	192	19
04100D40181M07	18 G 0,75	14,2	215,3	294	19
04100D40251M07	25 G 0,75	16,6	289,7	386	19
04100D40361M07	36 G 0,75	18,7	387,7	520	19
04100D40521M07	52 G 0,75	21,9	514,3	722	19
04100D40651M07	65 G 0,75	24,5	639,8	868	19
04100D41020M10	2 x 1	7,7	56,5	68	18
04100D40031M10	3G 1	8	66,4	82	18
04100D40041M10	4 G 1	8,5	77,3	97	18
04100D40051M10	5 G 1	9,3	89	114	18
04100D40071M10	7 G 1	10,7	117,9	159	18
04100D40121M10	12 G 1	12,8	174,9	239	18
04100D40181M10	18 G 1	15,2	270,2	353	18
04100D40251M10	25 G 1	18,4	367,5	481	18
04100D40361M10	36 G 1	20,3	478,7	633	18
04100D40521M10	52 G 1	23,8	668,9	884	18
04100D40651M10	65 G 1	26,8	805,7	1081	18
04100D41010M15	1 x 1,5	4,6	24,8	35	16
04100D41020M15	2 x 1,5	8,3	66,8	82	16
04100D40031M15	3G 1,5	8,8	81,5	104	16
04100D40041M15	4 G 1,5	9,4	101,2	125	16
04100D40051M15	5 G 1,5	10,1	122,2	145	16
04100D40071M15	7 G 1,5	11,9	156,8	206	16
04100D40121M15	12 G 1,5	14,7	269,7	341	16
04100D40181M15	18 G 1,5	16,9	369,2	465	16
04100D40251M15	25 G 1,5	20,4	493,4	633	16
04100D40361M15	36 G 1,5	23,0	660,3	856	16
04100D40521M15	52 G 1,5	26,9	931	1056	16
04100D40651M15	65 G 1,5	29,9	1132,8	1450	16
04100D41010M25	1 x 2,5	5,3	38	49	14
04100D41020M25	2 x 2,5	9,9	98,2	117	14
04100D40031M25	3G 2,5	10,6	122,8	159	14
04100D40041M25	4 G 2,5	11,5	150,1	197	14
04100D40051M25	5 G 2,5	12,6	179,6	236	14
04100D40071M25	7 G 2,5	15	265,2	335	14
04100D40121M25	12 G 2,5	18,5	417,1	525	14
04100D40181M25	18 G 2,5	21,8	571,4	739	14
04100D40251M25	25 G 2,5	26	780,8	1004	14
04100D40361M25	36 G 2,5	28,7	1058	1341	14
04100D40521M25	52 G 2,5	33	1479,3	1817	14
04100D41010M40	1 x 4	6	54,4	68	12
04100D41020M40	2 x 4	11,9	132,8	179	12
04100D40031M40	3 G 4	12,1	172,9	224	12
04100D40041M40	4 G 4	13,7	216,5	287	12
04100D40051M40	5 G 4	15,0	289,2	357	12
04100D40071M40	7 G 4	18	396,3	486	12
04100D41010M60	1 x 6	6,6	75,3	90	10
04100D41020M60	2 x 6	13,7	182,6	251	10
04100D40031M60	3 G 6	14,6	258,8	334	10
04100D40041M60	4 G 6	15,9	328,3	414	10
04100D40051M60	5 G 6	17,2	398,4	485	10
04100D40071M60	7 G 6	20,6	537,3	615	10
04100D41010M61	1 x 10	7,7	117,5	135	8
04100D40031M61	3 G 10	17,4	392,9	502	8
04100D40041M61	4 G 10	18,7	507,4	624	8
04100D40051M61	5 G 10	20,5	615,5	731	8
04100D41010M62	1 G 16	9,1	179,9	206	6
04100D40031M62	3 G 16	20,7	598,4	724	6
04100D40041M62	4 G 16	22,5	758,2	915	6
04100D40051M62	5 G 16	24,7	947,1	1101	6

TRACK CABLES

FLEXIDRUM® T 200 C

Continuously flexible TPE/PUR control cable, inner sheath and overall copper screen,300/500 V



Part no.	No. of cores x cross section n x mm ²	Outer-Ø ca. mm ± 10%	Copper weight kg/km	Cable weight approx. kg/km	AWG no. *)
04100D41010M63	1 x 25	10,7	287,7	306	4
04100D40031M63	3 G 25	23,9	898,2	1047	4
04100D40041M63	4 G 25	25,8	1148	1312	4
04100D40051M63	5 G 25	29,1	1400,1	1610	4
04100D41010M64	1 G 35	12,5	390,6	408	2
04100D40041M64	4 G 35	30,1	1546,4	1765	2
04100D40051M64	5 G 35	33,1	1915,1	2119	2
04100D41010M65	1 x 50	14,9	577,2	601	1
04100D40041M65	4 G 50	35,5	2165,3	2471	1
04100D41010M66	1 x 70	17,7	783,1	826	2/0
04100D41010M67	1 x 95	21,5	1051,2	1122	3/0
04100D41010M68	1 x 120	22,7	1293,1	1356	4/0
04100D41010M69	1 x 150	26,2	1611	1712	250
04100D41010M70	1 x 185	27,9	1952,4	2059	350
04100D41010M71	1 x 240	31,3	2507	2617	450

Other dimension and colours available on request.

TRACK CABLES

FLEXIDRUM® TD 200 C TP

Continuously flexible paired TPE/PUR data cable with colored cores and overall copper screen, max. 350 V



ELETTROTEK KABEL® FLEXIDRUM® TD 200 C TP

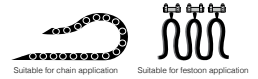

Construction:

Conductor:	flexible red copper conductor Cl. 6, acc to IEC 60228, DIN VDE 0295
Insulation:	special TPE compound
Colour cores:	acc. to DIN 47100
Stranding:	cores twisted in pairs, pairs twisted in layers
Wrapping:	non woven tape over each layer
Screen:	tinned copper braid
Wrapping:	non woven tape
Outer sheath:	grey (RAL 7032), PUR compound, acc. to UL 1581

Resistance:



Oil resistance:
very good TPU acc.to DIN VDE 0282 part 10 + HD 22.10,
DIN VDE 0473 part 811-2-1
IEC EN 60811-2-1



Halogen free acc. to:
DIN VDE 0482 part 267,
EN 50267-2-1,
IEC 60754-1

Technical data:

Nominal voltage:	DIN VDE: max. 350 V
Test voltage:	1,5 kV acc. to DIN VDE 0472 part 509 core/screen 1,2 kV
Temperature range	
<i>Fixed laying:</i>	-50°C up to +90°C
<i>Flexible installation:</i>	-40°C up to +90°C
Radiation resistance:	5 x 10 ⁷ cj/kg
Min. bending radius	
<i>Flexible installation:</i>	7,5 x d
Max speed (main application):	250 m/min

Features:

Labs uncritical (labs=enamel moisturing interfering substances)

good EMC characteristics

flexible at low temperatures

continuously flexible

high abrasion resistance

weather resistance

small outer diameter

mat surface outer sheath

travel > 10 m is possible

good against acids, alkalines, solvents, hydraulic liquids etc.

for SPEEDS and MINIMUM BENDING RADIUS
see pages from 2 to 8 of catalogue

RoHS and CE approval



TRACK CABLES

FLEXIDRUM® TD 200 C TP

Continuously flexible paired TPE/PUR data cable with colored cores and overall copper screen, max. 350 V



ELETTROTEK KABEL® FLEXIDRUM® TD 200 C TP

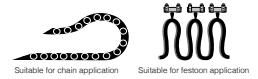
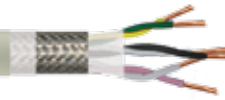

Part no.	No. of cores x cross section n x mm ²	Outer-Ø ca. mm ± 10%	Copper weight kg/km	Cable weight approx. kg/km	AWG no. *)
36340C64022M01	2 x 2 x 0,14	4,6	17,4	28	26
36340C64032M01	3 x 2 x 0,14	5,1	20,2	32	26
36340C64042M01	4 x 2 x 0,14	5,8	24,7	39	26
36340C64052M01	5 x 2 x 0,14	6,2	28,8	46	26
36340C64062M01	6 x 2 x 0,14	6,4	31,5	53	26
36340C64072M01	7 x 2 x 0,14	6,7	35,9	59	26
36340C64082M01	8 x 2 x 0,14	7,4	42	66	26
36340C64102M01	10 x 2 x 0,14	7,9	47,5	72	26
36340C64142M01	14 x 2 x 0,14	9	62,7	96	26
36340C64182M01	18 x 2 x 0,14	10	89,6	129	26
36340C64252M01	25 x 2 x 0,14	11,7	114,3	170	26
36340C64022M02	2 x 2 x 0,25	5,1	21,8	35	24
36340C64032M02	3 x 2 x 0,25	5,7	28,3	44	24
36340C64042M02	4 x 2 x 0,25	6,4	36,1	52	24
36340C64052M02	5 x 2 x 0,25	6,9	41,1	61	24
36340C64062M02	6 x 2 x 0,25	7,1	47,3	69	24
36340C64072M02	7 x 2 x 0,25	7,4	54,1	82	24
36340C64082M02	8 x 2 x 0,25	8,3	62,5	90	24
36340C64102M02	10 x 2 x 0,25	8,9	70,8	101	24
36340C64142M02	14 x 2 x 0,25	10,9	108,7	153	24
36340C64182M02	18 x 2 x 0,25	11,6	133,4	189	24
36340C64252M02	25 x 2 x 0,25	13,8	171,9	262	24
36340C64022M03	2 x 2 x 0,34	5,4	20,3	40	22
36340C64032M03	3 x 2 x 0,34	6	34,9	52	22
36340C64042M03	4 x 2 x 0,34	6,9	43,2	63	22
36340C64052M03	5 x 2 x 0,34	7,4	53,1	73	22
36340C64062M03	6 x 2 x 0,34	7,7	60,2	82	22
36340C64072M03	7 x 2 x 0,34	8	66,4	94	22
36340C64082M03	8 x 2 x 0,34	8,9	78,5	105	22
36340C64102M03	10 x 2 x 0,34	9,6	90,5	121	22
36340C64142M03	14 x 2 x 0,34	11,6	138,3	181	22
36340C64182M03	18 x 2 x 0,34	12,5	169,2	223	22
36340C64252M03	25 x 2 x 0,34	14,7	247,3	313	22
36340C64022M05	2 x 2 x 0,50	6,3	34,6	52	20
36340C64032M05	3 x 2 x 0,50	7,1	47,3	69	20
36340C64042M05	4 x 2 x 0,50	8,2	61,4	87	20
36340C64052M05	5 x 2 x 0,50	9,1	73,1	105	20
36340C64072M05	7 x 2 x 0,50	10	108,4	151	20
36340C64082M05	8 x 2 x 0,50	11,1	121,5	175	20
36340C64102M05	10 x 2 x 0,50	12,1	143,3	192	20
36340C64142M05	14 x 2 x 0,50	14,3	191,7	276	20
36340C64182M05	18 x 2 x 0,50	15,8	257,8	345	20
36340C64252M05	25 x 2 x 0,50	17,9	336,5	446	20
36340C64022M07	2 x 2 x 0,75	7,2	47,4	69	19
36340C64032M07	3 x 2 x 0,75	8,3	66,2	87	19
36340C64042M07	4 x 2 x 0,75	9,6	101	112	19
36340C64052M07	5 x 2 x 0,75	11,1	118,8	163	19
36340C64072M07	7 x 2 x 0,75	11,9	148	212	19
36340C64082M07	8 x 2 x 0,75	13,3	188	258	19
36340C64102M07	10 x 2 x 0,75	14,7	228	296	19
36340C64142M07	14 x 2 x 0,75	17,2	296,9	390	19
36340C64182M07	18 x 2 x 0,75	18,5	366,1	482	19
36340C64252M07	25 x 2 x 0,75	21,2	480,5	620	19
36340C64032M10	3 x 2 x 1	8,1	88	128	18
36340C64042M10	4 x 2 x 1	9	101,4	153	18
36340C64052M10	5 x 2 x 1	10,3	119,4	190	18

Other dimension and colours available on request.

TRACK CABLES

GAALTHERM® 180

Continuously flexible high temperature control cable with numbered cores, 0,6/1 kV



Construction:

Conductor:	flexible tinned copper conductor Cl. 6, acc to IEC 60228, DIN VDE 0295
Insulation:	GAALTHERM® 545
Colour cores:	black cores with consecutive numbers acc. to EN 50334, green-yellow from 3 cores
Stranding:	in layers
Wrapping:	non woven tape over each layer
Outer sheath:	grey (RAL 7000), GAALTHERM® 540

Resistance:



Self-extinguishing and flame retardant acc. to:
DIN VDE 0482 part 265-2-1
EN 50265-2-1
IEC 60332-1-2

Technical data:

Nominal voltage:	U ₀ /U 0,6/1 kV
Test voltage:	4 kV acc. to EN 50264
Temperature range	
<i>Fixed laying:</i>	-25°C up to +180°C
<i>Flexible installation:</i>	-25°C up to +180°C
<i>Short-time use:</i>	+ 200°C
Min. bending radius	
<i>Continuously flexible:</i>	10 x d

Features:

high temperature resistance
high notch resistance
very good flexibility
for MINIMUM BENDING RADIUS see pages from 5 to 8 of catalogue
RoHS and CE approval



Part no.	No. of cores x cross section n x mm ²	Outer-Ø ca. mm ± 10%	Copper weight kg/km	Cable weight approx. kg/km	AWG no. *)
51060G4L010M63	1 x 25	11,3	240	434	4
51060G4L010M67	1 x 95	20,9	912	-	3/0
51060G4L010M68	1 x 120	21,9	1152	-	4/0
51060G40031M15	3 G 1,5	8	43,2	100	16
51060G40041M15	4 G 1,5	8,5	57,6	120	16
51060G40051M15	5 G 1,5	9,5	72	150	16
51060G40071M15	7 G 1,5	10,5	100,8	210	16
51060G40031M25	3 G 2,5	10	72	148	14
51060G40041M25	4 G 2,5	10,5	96	185	14
51060G40051M25	5 G 2,5	11,8	120	240	14
51060G40071M25	7 G 2,5	13,8	168	330	14
51060G40121M25	12 G 2,5	16,5	288	483	14
51060G40191M25	19 G 2,5	20,3	456	710	14
51060G40041M40	4 G 4	12,5	153,6	275	12
51060G40051M40	5 G 4	13,8	192	340	12
51060G40071M40	7 G 4	16,3	268,8	480	12
51060G40041M60	4 G 6	15	230,4	420	10
51060G40051M60	5 G 6	16,8	288	500	10
51060G40071M60	7 G 6	19,9	403,2	700	10
51060G40041M61	4 G 10	18	384	620	8
51060G40051M61	5 G 10	19,3	480	750	8
51060G40041M62	4 G 16	20,7	614,4	920	6
51060G40051M62	5 G 16	23,6	768	1150	6
51060G40041M63	4 G 25	24,5	960	1320	4
51060G40041M64	4 G 35	28,6	1344	1810	2

Other dimension and colours available on request.

TRACK CABLES

GAALTHERM® 180 C

Continuously flexible high temperature control cable
with numbered cores and overall copper screen version, 0,6/1 kV



Construction:

Conductor:	flexible tinned copper conductor Cl. 6, acc to IEC 60228, DIN VDE 0295
Insulation:	GAALTHERM® 545
Colour cores:	black cores with consecutive numbers acc. to EN 50334, green-yellow from 3 cores
Stranding:	in layers
Wrapping:	non woven tape over each layer
Screen:	tinned copper braid
Outer sheath:	grey (RAL 7000), GAALTHERM® 540

Resistance:



Self-extinguishing and flame retardant acc. to:
DIN VDE 0482 part 265-2-1
EN 50265-2-1
IEC 60332-1-2

Technical data:

Nominal voltage:	U ₀ /U 0,6/1 kV
Test voltage:	4 kV acc. to EN 50264
Temperature range	
<i>Fixed laying:</i>	-25°C up to +180°C
<i>Flexible installation:</i>	-25°C up to +180°C
<i>Short-time use:</i>	+ 200°C
Min. bending radius	
<i>Continuously flexible:</i>	15 x d

Features:

high temperature resistance
high notch resistance
very good flexibility
for MINIMUM BENDING RADIUS
see pages from 5 to 8 of catalogue
RoHS and CE approval



Part no.	No. of cores x cross section n x mm ²	Outer-Ø ca. mm ± 10%	Copper weight kg/km	Cable weight approx. kg/km	AWG no. *)
51070G4L010M40	1 x 4	7	54,6	-	12
51070G4L010M61	1 x 10	9	118,7	-	8
51070G4L010M67	1 x 95	22	456	-	3/0
51070G4L010M68	1 x 120	23,5	2289,3	-	4/0
51070G40031M15	3 G 1,5	8,5	63,8	115	16
51070G40041M15	4 G 1,5	9	80,4	140	16
51070G40051M15	5 G 1,5	10	98,3	170	16
51070G40071M15	7 G 1,5	11,5	147,6	250	16
51070G40031M25	3 G 2,5	10	98,5	170	14
51070G40041M25	4 G 2,5	11,3	142,1	230	14
51070G40051M25	5 G 2,5	12,4	171,9	270	14
51070G40071M25	7 G 2,5	14,4	229,2	370	14
51070G40041M40	4 G 4	13	206,4	310	12
51070G40051M40	5 G 4	14,3	253,2	390	12
51070G40071M40	7 G 4	17	368	550	12
51070G40041M60	4 G 6	15,5	297,9	460	10
51070G40051M60	5 G 6	17,5	388	570	10
51070G40071M60	7 G 6	20,5	519,5	790	10
51070G40041M61	4 G 10	18	485,6	690	8
51070G40051M61	5 G 10	20	594,9	830	8
51070G40041M62	4 G 16	21,8	747,7	1010	6
51070G40051M62	5 G 16	24,3	922,4	1260	6
51070G40041M63	4 G 25	25,5	1117,5	1450	4
51070G40041M64	4 G 35	29,4	1532,5	1950	2

Other dimension and colours available on request.

TRACK CABLES

GAALTHERM® 180 UL

Continuously flexible high temperature control cable with numbered cores 0,6/1 kV, UL/CSA 1000 V



ELETTROTEK KABEL® GAALTHERM® 180 UL
UL Style 4476 200°C 1000 V cUL AWM I/II A/B 180°C

Construction:

Conductor:	flexible tinned copper conductor Cl. 6, acc to IEC 60228, DIN VDE 0295
Insulation:	GAALTHERM® 545
Colour cores:	black cores with consecutive numbers acc. to EN 50334, green-yellow from 3 cores
Stranding:	in layers
Wrapping:	non woven tape over each layer
Outer sheath:	grey (RAL 7000), GAALTHERM® 540

Resistance:



Self-extinguishing and flame retardant acc. to:
DIN VDE 0482 part 265-2-1
EN 50265-2-1
IEC 60332-1-2

Technical data:

Nominal voltage:	U ₀ /U 0,6/1 kV
UL/CSA:	1000 V
Test voltage:	4 kV acc. to EN 50264
Temperature range	
<i>Fixed laying:</i>	-25°C up to +180°C
<i>Flexible installation:</i>	-25°C up to +180°C
<i>Short-time use:</i>	+ 200°C
Min. bending radius	
<i>Continuously flexible:</i>	10 x d

Features:

high temperature resistance
high notch resistance
very good flexibility
UL AWM Style 4476 200°C 1000 V
cUL AWM I/II A/B 180°C
for MINIMUM BENDING RADIUS
see pages from 5 to 8 of catalogue

RoHS and CE approval



Part no.	No. of cores x cross section n x mm ²	Outer-Ø ca. mm ± 10%	Copper weight kg/km	Cable weight approx. kg/km	AWG no. *)
51080H40031A16	3 G 1,5	8	43,2	100	16
51080H40041A16	4 G 1,5	8,5	57,6	120	16
51080H40051A16	5 G 1,5	9,5	72	150	16
51080H40071A16	7 G 1,5	10,5	100,8	210	16
51080H40031A14	3 G 2,5	10	72	148	14
51080H40041A14	4 G 2,5	10,5	96	185	14
51080H40051A14	5 G 2,5	11,8	120	240	14
51080H40071A14	7 G 2,5	13,8	168	330	14
51080H40191A14	19 G 2,5	21,8	456	710	14
51080H40041A12	4 G 4	12,5	153,6	275	12
51080H40051A12	5 G 4	13,8	192	340	12
51080H40071A12	7 G 4	16,3	268,8	480	12
51080H40041A10	4 G 6	15	230,4	420	10
51080H40051A10	5 G 6	16,8	288	500	10
51080H40071A10	7 G 6	19,9	403,2	700	10
51080H40041A08	4 G 10	18	384	620	8
51080H40051A08	5 G 10	19,3	480	750	8
51080H40041A06	4 G 16	21	614,4	920	6
51080H40051A06	5 G 16	23,6	768	1150	6
51080H40041A04	4 G 25	24,5	960	1320	4
51080H40041A02	4 G 35	28,6	1344	1810	2

Other dimension and colours available on request.

TRACK CABLES



GAALTHERM® 180 C UL

Continuously flexible high temperature control cable
with numbered cores, and overall copper screen, 0,6/1 kV UL/CSA 1000 V

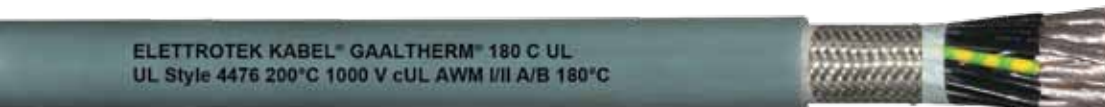

Construction:

- Conductor:** flexible tinned copper conductor Cl. 6, acc to IEC 60228, DIN VDE 0295
- Insulation:** GAALTHERM® 545
- Colour cores:** black cores with consecutive numbers acc. to EN 50334, green-yellow from 3 cores
- Stranding:** in layers
- Wrapping:** non woven tape over each layer
- Screen:** tinned copper braid
- Outer sheath:** grey (RAL 7000), GAALTHERM® 540

Resistance:



Self-extinguishing and flame retardant acc. to:
DIN VDE 0482 part 265-2-1
EN 50265-2-1
IEC 60332-1-2

Technical data:

- Nominal voltage:** U₀/U 0,6/1 kV
UL/CSA: 1000 V
- Test voltage:** 4 kV acc. to EN 50264
- Temperature range**
- Fixed laying:* -25°C up to +180°C
- Flexible installation:* -25°C up to +180°C
- Short-time use:* + 200°C
- Min. bending radius**
- Continuously flexible:* 15 x d

Features:

- high temperature resistance
- high notch resistance
- very good flexibility
- UL AWM Style 4476 200°C 1000 V
cUL AWM I/II A/B 180°C
- for MINIMUM BENDING RADIUS
see pages from 5 to 8 of catalogue

RoHS and CE approval



Part no.	No. of cores x cross section n x mm ²	Outer-Ø ca. mm ± 10%	Copper weight kg/km	Cable weight approx. kg/km	AWG no. *)
51090H4L010A12	1 x 4	7	54,6	-	12
51090H4L010A08	1 x 10	9	118,7	-	8
51090H4L010A3C	1 x 95	22	456	-	3/0
51090H4L010A4C	1 x 120	23,5	2289,3	-	4/0
51090H40031A16	3G1,5	8,5	63,8	115	16
51090H40041A16	4G1,5	9	80,4	140	16
51090H40051A16	5G1,5	10	98,3	170	16
51090H40071A16	7G1,5	11,5	147,6	250	16
51090H40031A14	3G2,5	10	98,5	170	14
51090H40041A14	4G2,5	11,3	142,1	230	14
51090H40051A14	5G2,5	12,4	171,9	270	14
51090H40071A14	7G2,5	14,4	229,2	370	14
51090H40041A12	4G4	13	206,4	310	12
51090H40051A12	5G4	14,3	253,2	390	12
51090H40071A12	7G4	17	368	550	12
51090H40041A10	4G6	15,5	297,9	460	10
51090H40051A10	5G6	17,5	388	570	10
51090H40071A10	7G6	20,5	519,5	790	10
51090H40041A08	4G10	18	485,6	690	8
51090H40051A08	5G10	20	594,9	830	8
51090H40041A06	4G16	21,8	747,7	1010	6
51090H40051A06	5G16	24,3	922,4	1260	6
51090H40041A04	4G25	25,5	1117,5	1450	4
51090H40041A02	4G35	29,4	1532,5	1950	2

Other dimension and colours available on request.

TRACK CABLES

FLEXIDRUM® TD 210

High speed continuously flexible PUR halogen-free data cable with colored cores, DIN VDE 300/500 UL/CSA 300V



ELETTROTEK KABEL® FLEXIDRUM® TD 210

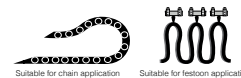

Construction:

- Conductor:** flexible red copper conductor Cl. 6, acc to IEC 60228, DIN VDE 0295
- Insulation:** special TPE compound
- Colour cores:** acc. to DIN 47100
- Stranding:** in layers
- Wrapping:** netting tape over each layer and overall non-woven tape
- Outer sheath:** grey (RAL 7032), PUR type TMPU, acc. to DIN VDE 0282 part 10 + HD 21.1

Resistance:



Self-extinguishing and flame retardant acc. to:
DIN VDE 0482 part 265-2-1
EN 50265-2-1
IEC 60332-1-2
UL VW-1, CSA FT1, (acc. to dimension) FT2



Oil resistance:
very good TMPU acc.to DIN VDE 0282 part 10
DIN VDE 0473 part 811-2-1
IEC EN 60811-2-1



Halogen free acc. to:
DIN VDE 0482 part 267,
EN 50267-2-1,
IEC 60754-1

Technical data:

- Nominal voltage:** **DIN VDE:** U₀/U 300/500 V
UL/CSA: 300 V
- Test voltage:** 1,5 kV acc. to DIN VDE 0472 part 509
- Temperature range** **DIN VDE:** **UL/CSA:**
Fixed laying: -50°C up to +90°C up to +80°C
Flexible installation: -40°C up to +90°C
- Radiation resistance:** 5 x 10⁷ cj/kg
- Min. bending radius**
Continuously flexible: 5 x d
- Max speed (main application):** 250 m/min

Features:

- flexible at low temperatures
- high abrasion resistance
- mat surface outer sheath
- good against acids,alkalines,solvents,hydraulic liquids etc

UL AWM Style 21198 80°C 300V
CSA AWM I/II A/B 80°C 300V FT1 FT2 CE

for SPEEDS and MINIMUM BENDING RADIUS
see pages from 2 to 8 of catalogue

RoHS and CE approval



Part no.	No. of cores x cross section n x mm ²	Outer-Ø ca.mm ± 10%	Copper weight kg/km	Cable weight approx. kg/km	AWG no. *)
36350C64030A26	3 x 0,14	3,8	4	15	26
36350C64040A26	4 x 0,14	4	5,4	18	26
36350C64050A26	5 x 0,14	4,4	6,7	21	26
36350C64070A26	7 x 0,14	5	9,4	27	26
36350C64100A26	10 x 0,14	5,5	13,4	33	24
36350C64140A26	14 x 0,14	5,9	18,8	40	26
36350C64180A26	18 x 0,14	6,8	24,2	52	26
36350C64250A26	25 x 0,14	8	33,6	66	26
36350C64030A24	3 x 0,25	4,4	7,2	21	24
36350C64040A24	4 x 0,25	4,7	9,6	24	24
36350C64050A24	5 x 0,25	5	12	28	24
36350C64070A24	7 x 0,25	5,7	16,8	37	24
36350C64100A24	10 x 0,25	6	24	48	24
36350C64140A24	14 x 0,25	6,5	33,6	60	24
36350C64180A24	18 x 0,25	8	43,2	73	24
36350C64250A24	25 x 0,25	9,4	60	99	24
36350C64030A22	3 x 0,34	4,6	9,8	25	22
36350C64040A22	4 x 0,34	4,7	13	28	22
36350C64050A22	5 x 0,34	5,3	16,3	33	22
36350C64070A22	7 x 0,34	6,1	22,8	44	22
36350C64100A22	10 x 0,34	6,8	32,6	55	22
36350C64140A22	14 x 0,34	7,3	45,7	73	22
36350C64180A22	18 x 0,34	8,5	58,8	91	22
36350C64250A22	25 x 0,34	10,2	81,6	124	22

Other dimension and colours available on request.

TRACK CABLES

FLEXIDRUM® T 210

High speed continuously flexible PUR halogen-free control cable,
DIN VDE 0,6/1 kV, UL/CSA 600/1000 V

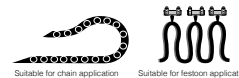

Construction:

- Conductor:** flexible red copper conductor Cl. 6,
acc to IEC 60228, DIN VDE 0295
- Insulation:** special TPE compound
- Colour cores:** black cores with consecutive numbers
acc. to EN 50334,
green-yellow from 3 cores
- Stranding:** in layers
- Wrapping:** non woven tape over each layer
- Outer sheath:** grey (RAL 7000), PUR compound
acc. to UL 1581

Resistance:



Self-extinguishing and flame retardant acc. to:
DIN VDE 0482 part 265-2-1
EN 50265-2-1
IEC 60332-1-2
UL VW-1, CSA FT1, FT2



Oil resistance:
very good TPU acc.to DIN VDE 0282 part 10
DIN VDE 0473 part 811-2-1
IEC EN 60811-2-1



Halogen free acc. to:
DIN VDE 0482 part 267,
EN 50267-2-1,
IEC 60754-1

Technical data:

- Nominal voltage:** **DIN VDE:** U₀/U 0,6/1 kV
UL/CSA: 600/1000 V
- Test voltage:** 3 kV acc. to DIN VDE 0281 part 2 + HD 21.2
- Temperature range** **DIN VDE:.** **UL/CSA:**
Fixed laying: -50°C up to +90°C up to +80°C
Flexible installation: -40°C up to +90°C
- Radiation resistance:** 5 x 10⁷ cj/kg
- Min. bending radius**
- Continuously flexible:* 5 x d
- Max speed (main application):** 250 m/min

Features:

- flexible at low temperatures
- high abrasion resistance
- mat surface outer sheath
- good against acids,alkalines,solvents,hydraulic liquids etc

UL AWM Style 21223 80°C 600 1000 V
CSA AWM I/II A/B 80°C 600V FT1 FT2 CE

for SPEEDS and MINIMUM BENDING RADIUS
see pages from 2 to 8 of catalogue

RoHS and CE approval



Part no.	No.of cores x cross section n x mm ²	Outer-Ø ca.mm ± 10%	Copper weight kg/km	Cable weight approx. kg/km	AWG no.)*
04110G40031A20	3 G 0,5	5,6	14,4	38	20
04110G40041A20	4 G 0,5	6,2	19,2	45	20
04110G40051A20	5 G 0,5	6,7	24	55	20
04110G40071A20	7 G 0,5	7,6	33,6	72	20
04110G40121A20	12 G 0,5	8,9	57,6	105	20
04110G40181A20	18 G 0,5	10,5	86,4	155	20
04110G40251A20	25 G 0,5	12,2	120	210	20
04110G40341A20	34 G 0,5	13,7	163,2	260	20
04110G40501A20	50 G 0,5	16,3	240	390	20
04110G40611A20	61 G 0,5	18,2	292,6	450	20
04110G41020A19	2x 0,75	5,8	14,6	41	19
04110G40031A19	3 G 0,75	6,5	21,6	55	19
04110G40041A19	4 G 0,75	6,6	28,8	60	19
04110G40051A19	5 G 0,75	7,2	36	75	19
04110G40071A19	7 G 0,75	8,6	50,4	100	19
04110G40121A19	12 G 0,75	10,3	86,4	150	19
04110G40181A19	18 G 0,75	11,8	129,6	220	19
04110G40251A19	25 G 0,75	14,2	180	290	19
04110G40341A19	34 G 0,75	15,8	244,8	380	19
04110G40501A19	50 G 0,75	18,7	360	540	19
04110G40611A19	61 G 0,75	20,8	439,2	650	19

TRACK CABLES

FLEXIDRUM® T 210

High speed continuously flexible PUR halogen-free control cable,
DIN VDE 0,6/1 kV, UL/CSA 600/1000V

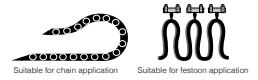

Part no.	No. of cores x cross section n x mm ²	Outer-Ø ca. mm ± 10%	Copper weight kg/km	Cable weight approx. kg/km	AWG no. *)
04110G41020A18	2x1	6,7	19,2	50	18
04110G40031A18	3 G 1	6,9	28,8	60	18
04110G40041A18	4 G 1	7,1	38,4	75	18
04110G40051A18	5 G 1	7,7	48	90	18
04110G40071A18	7 G 1	9	67,2	125	18
04110G40121A18	12 G 1	11	115,2	185	18
04110G40181A18	18 G 1	13	172,8	270	18
04110G40251A18	25 G 1	15,7	240	370	18
04110G40341A18	34 G 1	17,4	326,4	490	18
04110G40501A18	50 G 1	20,5	480	695	18
04110G40611A18	61 G 1	22,9	586,6	870	18
04110G41020A16	2x1,5	7,3	28,8	50	16
04110G40031A16	3 G 1,5	7,4	43,2	80	16
04110G40041A16	4 G 1,5	7,9	57,6	100	16
04110G40051A16	5 G 1,5	8,6	72	120	16
04110G40071A16	7 G 1,5	10,1	100,8	170	16
04110G40121A16	12 G 1,5	12,4	172,8	260	16
04110G40181A16	18 G 1,5	14,5	259,2	375	16
04110G40251A16	25 G 1,5	18	360	510	16
04110G40341A16	34 G 1,5	19,9	489,6	690	16
04110G40501A16	50 G 1,5	23,4	720	975	16
04110G40611A16	61 G 1,5	26	878,4	1200	16
04110G41020A14	2x2,5	8,3	48	78	14
04110G40031A14	3 G 2,5	8,8	72	125	14
04110G40041A14	4 G 2,5	10,2	96	160	14
04110G40051A14	5 G 2,5	11,1	120	190	14
04110G40071A14	7 G 2,5	13,2	168	270	14
04110G40121A14	12 G 2,5	15,8	288	420	14
04110G40181A14	18 G 2,5	18,6	432	620	14
04110G40251A14	25 G 2,5	22,8	600	830	14
04110G40031A12	3 G 4	10,5	115,2	180	12
04110G40041A12	4 G 4	11,4	153,6	230	12
04110G40051A12	5 G 4	12,5	192	290	12
04110G40031A10	3 G 6	12,4	172,8	260	10
04110G40041A10	4 G 6	13,8	230,4	330	10
04110G40051A10	5 G 6	15,1	288	420	10
04110G40031A08	3 G 10	15,6	288	430	8
04110G40041A08	4 G 10	17,3	384	360	8
04110G40051A08	5 G 10	19,3	480	520	8
04110G40031A06	3 G 16	18,2	460,8	620	6
04110G40041A06	4 G 16	20,2	614,4	800	6
04110G40051A06	5 G 16	22,4	768	1000	6
04110G40041A04	4 G 25	25,2	960	1200	4
04110G40051A04	5 G 25	25,7	1200	1500	4
04110G40041A02	4 G 35	26,8	1344	1620	2
04110G40051A02	5 G 35	28,7	1680	2030	2
04110G40051A01	4 G 50	34	1920	2280	1

Other dimension and colours available on request.

TRACK CABLES

FLEXIDRUM® TD 210 C

High speed continuously flexible PUR halogen-free with colored cores and overall copper screen, DIN VDE 300/500 UL/CSA 300 V



ELETTROTEK KABEL® FLEXIDRUM® TD 210 C

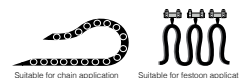

Construction:

Conductor:	flexible red copper conductor Cl. 6, acc to IEC 60228, DIN VDE 0295
Insulation:	special TPE compound
Colour cores:	acc. to DIN 47100
Stranding:	in layers
Wrapping:	netting tape over each layer and overall non-woven tape
Screen:	tinned copper braid
Wrapping:	non woven tape
Outer sheath:	grey (RAL 7032), PUR type TMPU, acc. to DIN VDE 0282 part 10 + HD 21.1

Resistance:



Self-extinguishing and flame retardant acc. to:

DIN VDE 0482 part 265-2-1
EN 50265-2-1
IEC 60332-1-2
UL VW-1, CSA FT1, (acc. to dimension) FT2



Oil resistance:

very good TMPU acc.to DIN VDE 0282 part 10
DIN VDE 0473 part 811-2-1
IEC EN 60811-2-1



Halogen free acc. to:

DIN VDE 0482 part 267,
EN 50267-2-1,
IEC 60754-1

Technical data:

Nominal voltage:	DIN VDE: U ₀ /U 300/500 V UL/CSA: 300 V
Test voltage:	1,5 kV acc. to DIN VDE 0472 part 509 core/screen 1,2 kV
Temperature range	DIN VDE: -50°C up to +90°C UL/CSA: up to +80°C
<i>Fixed laying:</i>	-50°C up to +90°C
<i>Flexible installation:</i>	-40°C up to +90°C
Radiation resistance:	5 x 10 ⁷ cj/kg
Min. bending radius	
<i>Continuously flexible:</i>	7,5 x d
Max speed (main application):	250 m/min

Features:

flexible at low temperatures
high abrasion resistance
mat surface outer sheath
good against acids,alkalines,solvents,hydraulic liquids etc
for SPEEDS and MINIMUM BENDING RADIUS
see pages from 2 to 8 of catalogue

AWM Style 21198 80°C 300V
CSA AWM I/II A/B 80°C 300V FT1 FT2 CE



Part no.	No.of cores x cross section n x mm ²	Outer-Ø ca.mm ± 10%	Copper weight kg/km	Cable weight approx. kg/km	AWG no.*)
36360C64030A26	3 x 0,14	3,8	13	22	26
36360C64040A26	4 x 0,14	4,1	16,2	27	26
36360C64050A26	5 x 0,14	4,3	17,7	32	26
36360C64070A26	7 x 0,14	4,9	22,7	45	26
36360C64100A26	10 x 0,14	5,6	41	50	24
36360C64140A26	14 x 0,14	6,3	45	58	26
36360C64180A26	18 x 0,14	6,7	53,2	82	26
36360C64250A26	25 x 0,14	7,8	71,2	105	26
36360C64030A24	3 x 0,25	4,8	18,1	28	24
36360C64040A24	4 x 0,25	5,1	20,7	33	24
36360C64050A24	5 x 0,25	5,5	25,1	43	24
36360C64070A24	7 x 0,25	6,2	32,5	55	24
36360C64100A24	10 x 0,25	6,8	52	65	24
36360C64140A24	14 x 0,25	7,5	62	75	24
36360C64180A24	18 x 0,25	8,5	75,6	108	24
36360C64250A24	25 x 0,25	10	100,8	135	24
36360C64030A22	3 x 0,34	5,1	20,4	35	22
36360C64040A22	4 x 0,34	4,5	26,2	44	22
36360C64050A22	5 x 0,34	5,8	29,7	54	22
36360C64070A22	7 x 0,34	6,6	53	65	22
36360C64100A22	10 x 0,34	7,2	65	85	22
36360C64140A22	14 x 0,34	8	75	100	22
36360C64180A22	18 x 0,34	9	96,6	128	22
36360C64250A22	25 x 0,34	10,8	131,5	170	22

Other dimension and colours available on request.

TRACK CABLES

FLEXIDRUM® T 210 C

High speed continuously flexible PUR halogen-free control cable
with overall copper screen, DIN VDE 0,6/1 kV, UL/CSA 600/1000 V

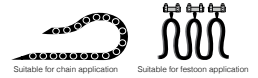

Construction:

Conductor:	flexible red copper conductor Cl. 6, acc to IEC 60228, DIN VDE 0295
Insulation:	special TPE compound
Colour cores:	black cores with consecutive numbers acc. to EN 50334, green-yellow from 3 cores
Stranding:	in layers
Wrapping:	tape over each layer
Screen:	tinned copper braid
Wrapping:	non-woven tape each layer
Outer sheath:	gray (similar to RAL 7000), PUR type TPU acc.to DIN VDE 0282 part.10 + HD 22.1

Resistance:



Self-extinguishing and flame retardant acc. to:

DIN VDE 0482 part 265-2-1
EN 50265-2-1
IEC 60332-1-2
UL VW-1, CSA FT1, (acc. to dimension) FT2



Oil resistance:

very good TPU acc.to DIN VDE 0282 part 10
DIN VDE 0473 part 811-2-1
IEC EN 60811-2-1



Halogen free acc. to:

DIN VDE 0482 part 267,
EN 50267-2-1,
IEC 60754-1 (equivalent DIN VDE 0472 part 815)

Technical data:

Nominal voltage:	DIN VDE: U ₀ /U 0,6/1 kV UL/CSA: 600/1000 V
Test voltage:	3 kV acc. to DIN VDE 0281 part 2 + HD 21.2 core/screen 2 kV
Temperature range	DIN VDE:. UL/CSA:
<i>Fixed laying:</i>	-50°C up to +90°C up to +80°C
<i>Flexible installation:</i>	-40°C up to +90°C
Radiation resistance:	5 x 10 ⁷ cJ/kg
Min. bending radius	
<i>Continuously flexible:</i>	7,5 x d
Max speed (main application):	250 m/min

Features:

flexible at low temperatures
high abrasion resistance
mat surface outer sheath
good against acids, alkalines, solvents, hydraulic liquids etc
good EMC resistance
 WM Style 21223 80°C 600 1000 V
CSA AWM I/II A/B 80°C 600V FT1 FT2 CE
for SPEEDS and MINIMUM BENDING RADIUS
see pages from 2 to 8 of catalogue

RoHS and CE approval



TRACK CABLES

FLEXIDRUM® T 210 C

High speed continuously flexible PUR halogen-free control cable
with overall copper screen, DIN VDE 0,6/1 kV, UL/CSA 600/1000 V

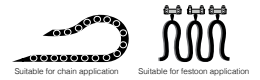

Part no.	No. of cores x cross section n x mm ²	Outer-Ø ca. mm ± 10%	Copper weight kg/km	Cable weight approx. kg/km	AWG no. *)
04120G40031A20	3 G 0,5	6,3	43,6	58	20
04120G40041A20	4 G 0,5	6,7	51,1	67	20
04120G40051A20	5 G 0,5	7,1	61,5	77	20
04120G40071A20	7 G 0,5	8,2	74,1	101	20
04120G40121A20	12 G 0,5	9,6	108,2	151	20
04120G40181A20	18 G 0,5	11,1	143	203	20
04120G40251A20	25 G 0,5	12,9	217	299	20
04120G40301A20	30 G 0,5	14,3	235	330	20
04120G40311A20	36 G 0,5	14,6	275,3	379	20
04120G41020A19	2 x 0,75	6,4	27,3	53	19
04120G40031A19	3 G 0,75	6,9	54,1	70	19
04120G40041A19	4 G 0,75	7,3	64	82	19
04120G40051A19	5 G 0,75	7,9	74,3	98	19
04120G40071A19	7 G 0,75	9,2	92,3	123	19
04120G40121A19	12 G 0,75	11	142,4	192	19
04120G40181A19	18 G 0,75	12,6	215,3	294	19
04120G40251A19	25 G 0,75	15,2	289,7	386	19
04120G40301A19	30 G 0,75	16,5	320	440	19
04120G40311A19	36 G 0,75	16,7	387,7	520	19
04120G40031A18	3 G 1	7,1	66,4	82	18
04120G40041A18	4 G 1	8,1	77,3	97	18
04120G40051A18	5 G 1	8,6	89	114	18
04120G40071A18	7 G 1	10	117,9	159	18
04120G40121A18	12 G 1	12	174,9	239	18
04120G40181A18	18 G 1	13,8	270,2	353	18
04120G40251A18	25 G 1	16,5	367,5	481	18
04120G40301A18	30 G 1	18	410	550	18
04120G40311A18	36 G 1	18,3	478,7	633	18
04120G41020A16	2x1,5	7,4	45	75	16
04120G40031A16	3 G 1,5	8,1	81,5	104	16
04120G40041A16	4 G 1,5	8,8	101,2	125	16
04120G40051A16	5 G 1,5	9,3	122,2	145	16
04120G40071A16	7 G 1,5	11,1	156,8	206	16
04120G40121A16	12 G 1,5	13,4	269,7	341	16
04120G40181A16	18 G 1,5	15,5	369,2	465	16
04120G40251A16	25 G 1,5	17,5	493,4	633	16
04120G40301A16	30 G 1,5	20,5	525	750	16
04120G40311A16	36 G 1,5	20,7	660,3	856	16
04120G41020A14	2x2,5	8,8	65,5	110	14
04120G40031A14	3 G 2,5	8,7	122,8	159	14
04120G40041A14	4 G 2,5	11	150,1	197	14
04120G40051A14	5 G 2,5	11,5	179,6	236	14
04120G40071A14	7 G 2,5	14	265,2	335	14
04120G40121A14	12 G 2,5	16,3	417,1	525	14
04120G40181A14	18 G 2,5	19,7	571,4	739	14
04120G40251A14	25 G 2,5	23,7	780,8	1004	14
04120G40031A12	3 G 4	11,2	172,9	224	12
04120G40041A12	4 G 4	12,1	216,5	287	12
04120G40051A12	5 G 4	13,2	289,2	357	12
04120G40031A10	3 G 6	13,1	258,8	334	10
04120G40041A10	4 G 6	14,7	328,3	414	10
04120G40051A10	5 G 6	16	398,4	485	10
04120G40031A08	3 G 10	16,5	392,9	502	8
04120G40041A08	4 G 10	18,3	507,4	624	8
04120G40051A08	5 G 10	20,5	615,5	731	8
04120G40031A06	3 G 16	19,1	598,4	724	6
04120G40041A06	4 G 16	21,1	758,2	915	6
04120G40051A06	5 G 16	23,3	947,1	1101	6
04120G40041A04	4 G 25	25,9	1148	1312	4
04120G40051A04	5 G 25	28,5	1400,1	1610	4
04120G40041A02	4 G 35	29,7	1546,4	1765	2
04120G40051A02	5 G 35	32,5	1915,1	2119	2

Other dimension and colours available on request.

TRACK CABLES

FLEXIDRUM® TD 210 C TP

High speed continuously flexible PUR halogen-free, screened, twisted pairs data cable,
DIN VDE 300/500 UL/CSA 300 V



ELETTROTEK KABEL® FLEXIDRUM® TD 210 C TP

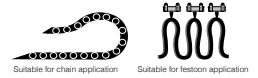

Construction:

Conductor:	flexible red copper conductor Cl. 6, acc to IEC 60228, DIN VDE 0295
Insulation:	special TPE compound
Colour cores:	acc. to DIN 47100
Stranding:	cores twisted in pairs, pairs twisted in layers
Wrapping:	netting tape over each layer
Screen:	tinned copper braid
Wrapping:	non woven tape
Outer sheath:	grey (RAL 7032), PUR type TMPU, acc. to DIN VDE 0282 part 10 + HD 21.1

Resistance:



Self-extinguishing and flame retardant acc. to:

DIN VDE 0482 part 265-2-1
EN 50265-2-1
IEC 60332-1-2
UL VW-1, CSA FT1, (acc. to dimension) FT2



Oil resistance:

very good TMPU acc.to DIN VDE 0282 part 10
DIN VDE 0473 part 811-2-1
IEC EN 60811-2-1



Halogen free acc. to:

DIN VDE 0482 part 267,
EN 50267-2-1,
IEC 60754-1

Technical data:

Nominal voltage:	DIN VDE: U ₀ /U 300/500 V UL/CSA: 300 V
Test voltage:	1,5 kV acc. to DIN VDE 0472 part 509 core/screen 1,2 kV
Temperature range	DIN VDE: UL/CSA:
<i>Fixed laying:</i>	-50°C up to +90°C up to +80°C
<i>Flexible installation:</i>	-40°C up to +90°C
Radiation resistance:	5 x 10 ⁷ cj/kg
Min. bending radius	
<i>Continuously flexible:</i>	7,5 x d
Max speed (main application):	250 m/min

Features:

flexible at low temperatures
high abrasion resistance
mat surface outer sheath
good against acids,alkalines,solvents,hydraulic liquids etc
good EMC resistance

AWM Style 21198 80°C 300 V
CSA AWM I/II A/B 80°C 300V FT1 FT2 CE
or:
c us AWM Style 20233 80°C 300 V FT2 CE

for SPEEDS and MINIMUM BENDING RADIUS
see pages from 2 to 8 of catalogue

RoHS and CE approval



TRACK CABLES

FLEXIDRUM® TD 210 C TP

High speed continuously flexible PUR halogen-free, screened, twisted pairs data cable,
DIN VDE 300/500 UL/CSA 300V



ELETTROTEK KABEL® FLEXIDRUM® TD 210 C TP



Part no.	No. of cores x cross section n x mm ²	Outer-Ø ca. mm ± 10%	Copper weight kg/km	Cable weight approx. kg/km	AWG no. *)
36370C64022A26	2 x 2 x 0,14	5,3	17,4	28	26
36370C64032A26	3 x 2 x 0,14	5,9	20,2	32	26
36370C64042A26	4 x 2 x 0,14	6,3	24,7	39	26
36370C64052A26	5 x 2 x 0,14	6,7	28,8	46	26
36370C64072A26	7 x 2 x 0,14	7,8	35,9	59	26
36370C64102A26	10 x 2 x 0,14	9	47,5	72	24
36370C64142A26	14 x 2 x 0,14	9,8	62,7	96	26
36370C64182A26	18 x 2 x 0,14	10,4	89,6	129	26
36370C64252A26	25 x 2 x 0,14	11,7	114,3	170	26
36370C64022A24	2 x 2 x 0,25	5,7	21,8	35	24
36370C64032A24	3 x 2 x 0,25	6,3	28,3	44	24
36370C64042A24	4 x 2 x 0,25	7	36,1	52	24
36370C64052A24	5 x 2 x 0,25	7,5	41,1	71	24
36370C64062A24	6 x 2 x 0,25	8,3	47,3	89	24
36370C64072A24	7 x 2 x 0,25	8,5	54,1	92	24
36370C64102A24	10 x 2 x 0,25	10	70,8	101	24
36370C64142A24	14 x 2 x 0,25	10,8	108,7	153	24
36370C64182A24	18 x 2 x 0,25	11,4	133,4	189	24
36370C64252A24	25 x 2 x 0,25	12,9	171,9	262	24
36370C64022A22	2 x 2 x 0,34	6,1	20,3	40	22
36370C64032A22	3 x 2 x 0,34	7	34,9	52	22
36370C64042A22	4 x 2 x 0,34	7,5	43,2	63	22
36370C64052A22	5 x 2 x 0,34	8,1	53,1	73	22
36370C64072A22	7 x 2 x 0,34	9,3	66,4	94	22
36370C64102A22	10 x 2 x 0,34	10,8	90,5	121	22
36370C64142A22	14 x 2 x 0,34	11,8	138,3	181	22
36370C64182A22	18 x 2 x 0,34	12,4	169,2	223	22
36370C64252A22	25 x 2 x 0,34	14,2	247,3	313	22
36370C64022A20	2 x 2 x 0,5	6,3	34,6	52	20
36370C64032A20	3 x 2 x 0,5	7,5	47,3	69	20
36370C64042A20	4 x 2 x 0,5	8,5	61,4	87	20
36370C64052A20	5 x 2 x 0,5	9,5	73,1	115	20
36370C64062A20	6 x 2 x 0,5	10,7	85,3	147	20
36370C64072A20	7 x 2 x 0,5	11	108,4	161	20
36370C64082A20	8 x 2 x 0,5	12	121,5	175	20
36370C64102A20	10 x 2 x 0,5	13	143,3	192	20
36370C64142A20	14 x 2 x 0,5	15	191,7	276	20
36370C64182A20	18 x 2 x 0,5	16,5	257,8	345	20
36370C64252A20	25 x 2 x 0,5	19,5	336,5	446	20
36370C64022A19	2 x 2 x 0,75	9	47,4	69	19
36370C64032A19	3 x 2 x 0,75	9,5	66,2	87	19
36370C64042A19	4 x 2 x 0,75	10,5	101	112	19
36370C64052A19	5 x 2 x 0,75	11,5	118,8	163	19
36370C64072A19	7 x 2 x 0,75	12,5	148	212	19
36370C64082A19	8 x 2 x 0,75	14	188,0	258	19
36370C64102A19	10 x 2 x 0,75	15,5	228,0	296	19
36370C64142A19	14 x 2 x 0,75	17,5	296,9	390	19
36370C64182A19	18 x 2 x 0,75	19,5	366,1	482	19
36370C64252A19	25 x 2 x 0,75	22,5	480,5	620	19
36370C64032A18	3 x 2 x 1	10	88	128	18
36370C64042A18	4 x 2 x 1	10,7	101,4	153	18
36370C64052A18	5 x 2 x 1	11,7	119,4	190	18
36370C64062A18	6 x 2 x 1	12,8	140	250	18
36370C64062A16	6 x 2 x 1,5	14,8	226	319	16

Other dimension and colours available on request.



SERVO CABLES



GAALFLEX® SERVO T 806 UL

PVC motor connection cable

GAALFLEX® SERVO T 806 C UL

PVC motor connection cable with overall copper screen



Construction:

Conductor:	flexible red copper conductor Cl. 5 acc to IEC 60228, DIN VDE 0295
Insulation:	special PP compound
Colour cores:	black cores with consecutive numbers acc. to EN 50334 +green-yellow
Stranding:	in layers
Wrapping (T 806 C UL):	PETP foil
Screen (T 806 C UL):	tinned copper braid
Outer sheath:	orange (RAL 2003), special PVC compound 90°C

Resistance:



Self-extinguishing and flame retardant acc. to:
DIN VDE 0472 part 804 test method B,
IEC 60332-1, IEC 60332-3-24, CSA FT1



Oil resistance acc. to:
EN 50290-2-22, VDE 0819-102

Technical data:

Nominal voltage:	Uo/U 0,6/1 kV UL/CSA: 1000 V
Test voltage:	supply cores:4kV core screen: 1,5 kV
Temperature range	
<i>Fixed laying:</i>	- 40°C up to + 80°C
<i>Flexible installation:</i>	- 10°C up to + 80°C
Min. bending radius (T 806 UL)	
<i>Fixed laying:</i>	4 x d
<i>Flexible installation:</i>	15 x d
Min. bending radius (T 806 C UL)	
<i>Fixed laying:</i>	6 x d
<i>Flexible installation:</i>	20 x d

Features:

UL AWM STYLE 2570 80°C 1000 V, CSA AWM I/II A/B

low capacitance

oil resistance

DESINA® colours

for SPEEDS and MINIMUM BENDING RADIUS
see pages from 2 to 8 of catalogue

RoHS and CE approval



DESINA® T 806 UL

Part no.	No. of cores x cross section n x mm ²	Outer-Ø ca. mm ± 10%	Copper weight kg/km	Cable weight approx. kg/km	AWG no. *)
37170HG0041A19	4 G 0,75	7,1	28,8	76	19
37170HG0041A18	4 G 1	7,7	38,4	92	18
37170HG0041A16	4 G 1,5	8,5	57,6	120	16
37170HG0041A14	4 G 2,5	9,8	96	173	14
37170HG0041A12	4 G 4	11,6	153,6	255	12
37170HG0041A10	4 G 6	14,3	230,4	385	10
37170HG0041A08	4 G 10	17,2	384	595	8
37170HG0041A06	4 G 16	20,3	614,4	888	6
37170HG0041A04	4 G 25	23,6	960	1296	4

SERVO CABLES



GAALFLEX® SERVO T 806 UL

PVC motor connection cable

GAALFLEX® SERVO T 806 C UL

PVC motor connection cable with overall copper screen

ELETTROTEK KABEL® GAALFLEX® SERVO T 806 UL

ELETTROTEK KABEL® GAALFLEX® SERVO T 806 C UL

DESINA® T 806 C UL

Part no.	No. of cores x cross section n x mm ²	Outer-Ø ca. mm ± 10%	Copper weight kg/km	Cable weight approx. kg/km	AWG no. *)
37180HG0041A16	4 G 1,5	8,2	82,3	120	16
37180HG0041A14	4 G 2,5	9,7	130,5	179	14
37180HG0041A12	4 G 4	11,5	193	256	12
37180HG0041A10	4 G 6	13,3	274,7	354	10
37180HG0041A08	4 G 10	16,3	463	568	8
37180HG0041A06	4 G 16	20,0	711	867	6
37180HG0041A04	4 G 25	24,5	1082,9	1309	4
37180HG0041A02	4 G 35	27,7	1475,8	1738	2
37180HG0041A01	4 G 50	33,2	2125,7	2498	1

DESINA® T 806 C UL + 1 screened pair

Part no.	No. of cores x cross section n x mm ²	Outer-Ø ca. mm ± 10%	Copper weight kg/km	Cable weight approx. kg/km	AWG no. *)
37182HG004BA16	4 G 1,5 + (2 x 1)C	11,7	132,8	168,2	16
37182HG004BA14	4 G 2,5 + (2 x 1)C	12,7	176	220,6	14
37182HG004BA12	4 G 4 + (2 x 1)C	14,2	250	305,8	12
37182HG004BA10	4 G 6 + (2 x 1)C	15,9	335,3	411	10
37183HG004BA16	4 G 1,5 + (2 x 1,5)C	12,1	144,9	170,9	16
37183HG004BA14	4 G 2,5 + (2 x 1,5)C	13,1	188,1	223,1	14
37183HG004BA12	4 G 4 + (2 x 1,5)C	14,6	270,6	315,7	12
37183HG004BA10	4 G 6 + (2 x 1,5)C	16,3	355,8	420,9	10
37183HG004BA08	4 G 10 + (2 x 1,5)C	18,9	517,9	617	8
37183HG004BA06	4 G 16 + (2 x 1,5)C	22	765,3	907,9	6
37183HG004BA04	4 G 25 + (2 x 1,5)C	26,2	1127,8	1344,4	4
37183HG004BA02	4 G 35 + (2 x 1,5)C	29,3	1528,8	1784	2
37183HG004BA01	4 G 50 + (2 x 1,5)C	34,4	2167,7	2534,8	1

DESINA® T 806 C UL + 2 screened pairs

Part no.	No. of cores x cross section n x mm ²	Outer-Ø ca. mm ± 10%	Copper weight kg/km	Cable weight approx. kg/km	AWG no. *)
37180HG004B900	4 G 1 + (2 x 0,75)C + (2 x 0,75)C	12,1	142,4	227	18
37180HG004B901	4 G 1,5 + (2 x 0,75)C + (2 x 0,75)C	12,7	166,5	255,8	16
37180HG004B902	4 G 1,5 + (2 x 1)C + (2 x 1)C	13,1	176,1	268,7	16
37180HG004B903	4 G 2,5 + (2 x 1)C + (2 x 1)C	14,4	230,8	334,4	14
37180HG004B904	4 G 4 + (2 x 1)C + (2 x 1,5)C	16,3	319,6	445,9	12
37180HG004B905	4 G 6 + (2 x 1)C + (2 x 1,5)C	17,9	404,9	552,2	10
37180HG004B906	4 G 10 + (2 x 1)C + (2 x 1,5)C	20,4	566,9	750,8	8
37180HG004B907	4 G 16 + (2 x 1,5)C + (2 x 1,5)C	23,5	828,5	1059,3	6
37180HG004B908	4 G 25 + (2 x 1,5)C + (2 x 1,5)C	27,2	1191,1	1492	4
37180HG004B909	4 G 35 + (2 x 1,5)C + (2 x 1,5)C	30,4	1592	1934,4	2

Other dimension and colours available on request.

SERVO CABLES

GAALFLEX® SERVO T 807 C

PE/PVC feedback cable with coloured cores and overall copper screen

GAALFLEX® SERVO T 808 C

paired PE/PVC transmission cable with coloured cores and overall copper screen

ELETTROTEK KABEL® GAALFLEX® SERVO T 807 C

ELETTROTEK KABEL® GAALFLEX® SERVO T 808 C

Construction:

Conductor:	stranded red copper conductor, acc. to DIN VDE 0812
Insulation:	PE type L/MD acc. to DIN VDE 0819 part. 103
Colour cores:	acc. to DIN 47100
Stranding	
<i>T 807 C:</i>	in layers
<i>T 808 C:</i>	supply cores: in layers control cores: in pairs
Screen:	acc to dimension: pairs screened or wrapped individually with tinned copper braid
Wrapping:	PETP foil
Stranding:	supply cores and control cores together in layers
Wrapping:	PETP foil
Screen:	tinned copper braid
Wrapping:	non-woven tape
Outer sheath:	grey (RAL 7000), PVC type TM2, acc. to DIN VDE 0281 part. 1

Resistance:



Oil resistance acc. to:
internal standard, IEC 60811-2-1

Technical data:

Peak operating voltage

T 807 C: max. 500 V

T 808 C: max. 350 V

Test voltage: 2kV

Temperature range

Fixed laying: - 30°C up to +70°C

Flexible installation: - 5°C up to + 70°C

Radiation resistance: 8×10^7 cJ/kg

Min. bending radius

Fixed laying: 5 x d

Flexible installation: 10 x d

Continuously flexible: 12 x d

Features:

- possible standard DESINA
- very good EMC characteristics
- high functionality
- space-saving application
- good handling
- chemical resistant
- Weather resistant
- RoHS and CE approval



SERVO CABLES

GAALFLEX® SERVO T 807 C

PE/PVC feedback cable with coloured cores and overall copper screen

GAALFLEX® SERVO T 808 C

paired PE/PVC transmission cable with coloured cores and overall copper screen



Part no.	No. of cores x cross section n x mm ²	Outer-Ø ca. mm ± 10%	Copper weight kg/km	Cable weight approx. kg/km	AWG no. *)
Motor feedback cable					
37110D44090M05	9 x 0,5	8,4	68,2	107	20
Transmission cable					
37120C44049900	4 x 2 x 0,25 + 2 x 0,5	8,1	53,7	82	24/20
37120C44049901	4 x 2 x 0,25 + 2 x 1	8,4	63,3	93	24/18
37120C44049902	4 x 2 x 0,14 + 4 x 0,5	8,3	54,9	85	26/20
37120C44109903	10 x 0,14 + 2 x 0,5	7,4	44	73	26/20
37120C44109904	10 x 0,14 + 4 x 0,5	8,0	57,5	92	26/20
37120C44049905	4 x 2 x 0,38 + 4 x 0,5	10,1	78,7	128	-/20
37120C44039906	3 x (2 x 0,14)C + 2 x 1	8,2	77,9	100	26/18
37120C44039907	3 x (2 x 0,14)C + 2 x (0,5)C	8,2	81,9	100	26/18
37120DEX042908	4x(2x0,34)C	10,2	102	160	22

Other dimension and colours available on request.

SERVO CABLES



SPECIAL GAALFLEX® SERVO T 830

PVC motor connection cable

SPECIAL GAALFLEX® SERVO T 830 C

PVC motor connection cable with overall copper screen



Construction:

Conductor:	flexible red copper conductor Cl. 6 acc to IEC 60228, DIN VDE 0295
Insulation:	special PP compound
Colour cores:	black cores with consecutive numbers acc. to EN 50334 +green-yellow
Stranding:	in layers
Wrapping:	non-woven tape
Screen (SPECIAL T 830 C):	tinned copper braid
Wrapping (SPECIAL T 830 C):	non-woven tape
Outer sheath:	orange (RAL 2003), special PVC compound 90°C

Resistance:



Self-extinguishing and flame retardant acc. to:
DIN VDE 0472 part 804 test method B,
IEC 60332-1, IEC 60332-3-24, CSA FT1



Oil resistance acc. to:
EN 50363-4-1

Technical data:

Nominal voltage:	Uo/U 0,6/1 kV UL/CSA: 1000 V
Test voltage:	supply cores:4kV core screen: 1,5 kV
Temperature range	
<i>Fixed laying:</i>	- 40°C up to + 80°C
<i>Flexible installation:</i>	- 10°C up to + 80°C
Min. bending radius	
<i>Fixed laying:</i>	4 x d
<i>Flexible installation:</i>	7,5 x d
Max speed (main application):	
<i>unsupported:</i>	8 m/sec
<i>gliding:</i>	4 m/sec
Max acceleration (main application):	30 m/sec ²
Bending cycles (main application):	up to 6 million
Travel distances (main application):	up to 10 mt

Features:

UL AWM STYLE 2570 80°C 1000 V, CSA AWM I/II A/B

suitable for track cables
speed 8 m/sec (unsupported), 4 m/sec (gliding), acc. 30 m/sec²

low capacitance

high oil resistance

high flexibility

DESINA® colours

for SPEEDS and MINIMUM BENDING RADIUS
see pages from 2 to 8 of catalogue

RoHS and CE approval



DESINA® T 830

Part no.	No. of cores x cross section n x mm ²	Outer-Ø ca.mm ± 10%	Copper weight kg/km	Cable weight approx. kg/km	AWG no.)*
37010HG0041A19	4 G 0,75	6,9	28,8	76	19
37010HG0041A18	4 G 1	7,4	38,4	92	18
37010HG0041A16	4 G 1,5	8,1	57,6	120	16
37010HG0041A14	4 G 2,5	9,5	96	173	14
37010HG0041A12	4 G 4	11,2	153,6	255	12
37010HG0041A10	4 G 6	13,4	230,4	385	10
37010HG0041A08	4 G 10	16,3	384	595	8
37010HG0041A06	4 G 16	20,3	614,4	888	6
37010HG0041A04	4 G 25	24,2	960	1296	4

SERVO CABLES



SPECIAL GAALFLEX® SERVO T 830

PVC motor connection cable

SPECIAL GAALFLEX® SERVO T 830 C

PVC motor connection cable with overall copper screen

ELETTROTEK KABEL® SPECIAL GAALFLEX® SERVO T 830

ELETTROTEK KABEL® SPECIAL GAALFLEX® SERVO T 830 C



DESINA® T 830 C

Part no.	No. of cores x cross section n x mm ²	Outer-Ø ca. mm ± 10%	Copper weight kg/km	Cable weight approx. kg/km	AWG no. (*)
37020HG0041A19	4 G 0,75	7,5	51,4	87	19
37020HG0041A18	4 G 1	8	66,7	105	18
37020HG0041A16	4 G 1,5	8,7	85,8	130	16
37020HG0041A14	4 G 2,5	10,1	130,2	183	14
37020HG0041A12	4 G 4	11,8	198,7	265	12
37020HG0041A10	4 G 6	14,4	300,6	397	10
37020HG0041A08	4 G 10	17,3	474,4	601	8
37020HG0041A06	4 G 16	21,3	724,9	913	6
37020HG0041A04	4 G 25	25	1090,8	1320	4
37020HG0041A02	4 G 35	30,2	1504,9	1863	2
37020HG0041A01	4 G 50	35,9	2155,8	2650	1
37020HG0041A2C	4 G 70	42,3	2970,8	3637	2/0

DESINA® SPECIAL T 830 C + 1 screened pair

Part no.	No. of cores x cross section n x mm ²	Outer-Ø ca. mm ± 10%	Copper weight kg/km	Cable weight approx. kg/km	AWG no. (*)
37025HG004BA19	4 G 0,75 + (2 x 0,5)C	10	89,6	124,2	19
37025HG004BA16	4 G 1,5 + (2 x 0,5)C	11,1	124,3	166,7	16
37025HG004BA14	4 G 2,5 + (2 x 0,5)C	11,3	162,6	207	14
37026HG004BA16	4 G 1,5 + (2 x 0,75)C	12,2	137,1	179,8	16
37026HG004BA14	4 G 2,5 + (2 x 0,75)C	12,4	175,4	220,3	14
37027HG004BA16	4 G 1,5 + (2 x 1)C	11,7	143,8	218,8	16
37027HG004BA14	4 G 2,5 + (2 x 1)C	12,7	187,8	271,4	14
37027HG004BA12	4 G 4 + (2 x 1)C	14,2	265,1	357,7	12
37027HG004BA10	4 G 6 + (2 x 1)C	15,9	352	466,3	10
37027HG004BA08	4 G 10 + (2 x 1)C	18,6	525,3	637,3	8
37027HG004BA06	4 G 16 + (2 x 1)C	22,2	775,9	936,4	6
37028HG004BA16	4 G 1,5 + (2 x 1,5)C	12,1	156,5	233,9	16
37028HG004BA14	4 G 2,5 + (2 x 1,5)C	13,1	200,6	286,7	14
37028HG004BA12	4 G 4 + (2 x 1,5)C	14,6	287,3	381,3	12
37028HG004BA10	4 G 6 + (2 x 1,5)C	16,3	374,3	490,2	10
37028HG004BA08	4 G 10 + (2 x 1,5)C	18,9	537,9	686,4	8
37028HG004BA06	4 G 16 + (2 x 1,5)C	22	788,4	979,7	6
37028HG004BA04	4 G 25 + (2 x 1,5)C	26,2	1154,5	1399,1	4
37028HG004BA02	4 G 35 + (2 x 1,5)C	30,6	1568,3	1914	2

DESINA® SPECIAL T 830 C + 2 screened pairs

Part no.	No. of cores x cross section n x mm ²	Outer-Ø ca. mm ± 10%	Copper weight kg/km	Cable weight approx. kg/km	AWG no. (*)
37025HG004B900	4 G 0,75 + (2 x 0,5)C + (2 x 0,5)C	11,2	122,1	196,7	19
37025HG004B901	4 G 1 + (2 x 0,75)C + (2 x 0,75)C	12,1	152,5	233,6	18
37025HG004B902	4 G 1,5 + (2 x 0,75)C + (2 x 0,75)C	12,7	177,1	264,8	16
37025HG004B903	4 G 2,5 + (2 x 1)C + (2 x 1)C	14,4	248,4	349,9	14
37025HG004B904	4 G 4 + (2 x 1)C + (2 x 1,5)C	16,3	338,5	460,5	12
37025HG004B905	4 G 6 + (2 x 1)C + (2 x 1,5)C	17,9	425,1	571,6	10
37025HG004B906	4 G 10 + (2 x 1)C + (2 x 1,5)C	20,4	589,2	771,9	8
37025HG004B907	4 G 16 + (2 x 1,5)C + (2 x 1,5)C	23,5	852,1	1082,5	6
37025HG004B908	4 G 25 + (2 x 1,5)C + (2 x 1,5)C	27,2	1217,6	1501,1	4

Other dimension and colours available on request.

SERVO CABLES

GAALFLEX® SERVO T 828 C

TPE/PVC with overall copper screen, acc.to SIEMENS standard 6FX5008



ELETTROTEK KABEL® GAALFLEX® SERVO T 828 C

Construction:

Conductor:	flexible red copper conductor Cl. 5 acc to IEC 60228, DIN VDE 0295
Insulation:	special TPE compound
Colour cores:	black cores with consecutive numbers acc. to EN 50334 green-yellow from 3 cores
Stranding:	In layers + fillers
Wrapping:	plastic tape
Screen:	tinned copper braid
Outer sheath:	orange (RAL 2003), special PVC compound

Resistance:



Self-extinguishing and flame retardant acc.to:

IEC 60332-1-2
EN 60332-1-2
UL CSA FT-1,FT-2



Oil resistance acc. to:

DIN VDE 0473 part 811-2-1
IEC 60811-2-1

Technical data:

Nominal voltage:	U ₀ /U 0,6/1 kV UL/CSA: 1000 V
Test voltage:	supply cores: 4kV x 5 min core screen: 1,5 kV x 1 min
Temperature range	DIN VDE: UL/CSA: up to + 90°C
<i>Fixed laying:</i>	- 30°C up to + 90°C
<i>Flexible installation:</i>	- 5°C up to + 90°C
Radiation resistance:	5 x 10 ⁷ cj/kg
Min. bending radius	
<i>Fixed laying:</i>	5 x d
<i>Flexible installation:</i>	10 x d
<i>Continuously flexible:</i>	18 x d

Features:

UL AWM style 2570 80°C 1000 V
CSA AWM I/II A/B 80°C 1000 V FT1 FT2

- oil resistant
- good chemical resistant
- adhesion-free installation
- DESINA® colours
- RoHS and CE approval



DESINA® SIEMENS

Part no.	acc.to SIEMENS Standard	No.of cores x cross section n x mm ²	Outer-Ø ca.mm ± 10%	Copper weight kg/km	Cable weight approx. kg/km	AWG no.)*
37030HG0041A16	6FX5008-1BB11	4 G 1,5	8	78	120	16
37030HG0041A14	6FX5008-1BB21	4 G 2,5	10	121	173	14
37030HG0041A12	6FX5008-1BB31	4 G 4	11	194	255	12
37030HG0041A10	6FX5008-1BB41	4 G 6	14	291	370	10
37030HG0041A08	6FX5008-1BB51	4 G 10	19	477	670	8
37030HG0041A06	6FX5008-1BB61	4 G 16	24	700	1065	6

Other dimension and colours available on request.

GAALFLEX® SERVO T 829 C

TPE/PVC with overall copper screen, acc.to SIEMENS standard 6FX5008



ELETTROTEK KABEL® GAALFLEX® SERVO T 829 C

Construction:

Conductor:	flexible red copper conductor Cl. 5 acc to IEC 60228, DIN VDE 0295
Insulation:	special TPE compound
Colour cores:	black cores with consecutive numbers acc. to EN 50334 green-yellow from 3 cores
Stranding:	In layers + fillers
Wrapping:	plastic tape
Screen:	tinned copper braid
Outer sheath:	orange (RAL 2003), special PVC compound

Resistance:



Self-extinguishing and flame retardant acc.to:
IEC 60332-1-2
EN 60332-1-2
UL CSA FT-1,FT-2



Oil resistance acc. to:
DIN VDE 0473 part 811-2-1
IEC 60811-2-1

Technical data:

Nominal voltage:	U ₀ /U 0,6/1 kV UL/CSA: 1000 V
Test voltage:	supply cores: 4kV x 5 min core screen: 1,5 kV x 1 min
Temperature range	DIN VDE: UL/CSA: up to + 80°C
<i>Fixed laying:</i>	- 40°C up to +70°C
<i>Flexible installation:</i>	- 5°C up to + 70°C
Radiation resistance:	5 x 10 ⁻⁷ cj/kg
Min. bending radius	
<i>Fixed laying:</i>	5 x d
<i>Flexible installation:</i>	10 x d
<i>Continuously flexible:</i>	18 x d

Features:

UL AWM style 2570 80°C 1000 V
CSA AWM I/II A/B 80°C 1000 V FT1 FT2

adhesion-free installation

DESINA® colours

RoHS and CE approval



SIEMENS

Part no.	acc.to SIEMENS Standard	No.of cores x cross section n x mm ²	Outer-Ø ca.mm ± 10%	Copper weight kg/km	Cable weight approx. kg/km	AWG no.)*
37040HG004BA16	6FX5008-1BA11	4 G 1,5 + (2 x 1,5)C	10	131	190	16/16
37040HG004BA14	6FX5008-1BA21	4 G 2,5 + (2 x 1,5)C	12	170	240	14/16
37040HG004BA12	6FX5008-1BA31	4 G 4 + (2 x 1,5)C	14	253	340	12/16
37040HG004BA10	6FX5008-1BA41	4 G 6 + (2 x 1,5)C	16	340	460	10/16
37040HG004BA08	6FX5008-1BA51	4 G 10 + (2 x 1,5)C	21	535	775	8/16
37040HG004BA06	6FX5008-1BA61	4 G 16 + (2 x 1,5)C	24	750	1115	6/16
37040HG004BA04	6FX5008-1BA25	4 G 25 + (2 x 1,5)C	28	1160	1531	4/16
37040HG004BA02	6FX5008-1BA35	4 G 35 + (2 x 1,5)C	31	1540	2010	2/16
37040HG004BA01	6FX5008-1BA50	4 G 50 + (2 x 1,5)C	36,5	2150	2765	1/16

Other dimension and colours available on request.

SERVO CABLES

GAALFLEX® SERVO T 839 C

paired PUR transmission cable with coloured cores and overall copper screen



ELETTROTEK KABEL® GAALFLEX® SERVO T 839 C



Construction:

Conductor:	flexible tinned copper acc. to DIN VDE 0812
Insulation:	special polymer compound
Colour cores:	DIN 47100 as far applicable
Screen:	pairs screened individually with tinned copper braid
Inner sheath:	special polymer compound
Stranding:	cores twisted together in pairs and in layers
Wrapping:	non woven tape or PETP foill
Screen:	tinned copper braid
Wrapping:	non-woven tape
Outer sheath:	green (RAL 6018), PUR type TMPU acc.to DIN VDE 0282 part 10 + HD 22.1, or green (RAL 6018), PUR type PU acc. to UL 758

Resistance:



Self-extinguishing and flame retardant acc.to:
IEC 60332-1-2
EN 60332-1-2
UL CSA FT-1,FT-2



Oil resistance:
very good - PUR TMPU acc. to DIN VDE 0282 part.10+ HD 22.10



Halogen free acc.to:
DIN VDE 0472 part 815 + IEC

Technical data:

Nominal voltage:	max. 30 V UL: 30 V
Test voltage:	750 V
Temperature range	DIN VDE: UL: up to + 80°C
<i>Fixed laying:</i>	- 50°C up to + 80°C
<i>Flexible installation:</i>	- 40°C up to + 80°C
Radiation resistance:	5 x 10 ⁷ cj/kg
Min. bending radius	
<i>Fixed laying:</i>	5 x d
<i>Flexible installation:</i>	10 x d
<i>Continuously flexible:</i>	12 x d
Max speed (main application):	250 m/min

Features:

UL AWM style 20236 80°C 30 V

good EMC characteristics

flexible installation

oil resistant

very good weather resistance

good against acids, alkalines, solvents, hydraulic liquids etc. or oil-rating 60°C acc. to UL 758

long service life

adhesion-free installation

halogen-free

labs uncritical

mat surface outer sheath

DESINA® colours

for SPEEDS and MINIMUM BENDING RADIUS see pages from 2 to 8 of catalogue

RoHS and CE approval



SERVO CABLES

GAALFLEX® SERVO T 839 C

paired PUR transmission cable with coloured cores and overall copper screen



ELETTROTEK KABEL® GAALFLEX® SERVO T 839 C

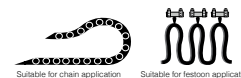

Sheath material PU acc. to UL 758

Part no.	Color code	No. of cores x cross section n x mm ²	Outer Ø ca. mm ±10%	Copper weight kg/km	Cable weight approx. kg/km	AWG no.)*
37140AE4029901	special colored	2 x 2 x 0,15 + 2 x 0,38	6,9	28,1	52	-/-
37140AE4029902	DIN 47100	4 x 0,18	4,9	18,9	28	-
37140AE4022903	DIN 47100	4 x 2 x 0,18	6,3	30,8	47	-
37140AE4029904	special colored	4 x 2 x 0,25 + 2 x 1	8	61	96	24/18
37140AE4029905	special colored	4 x 2 x 0,14 + 4 x 0,5	8	49,7	74	26/20
37140AE4039906	special colored	3 x (2 x 0,25)D2Y + 4 x 0,5	9,7	81,9	122	24/20
37140AE4029907	special colored	3 x 2 x 0,25 + 2 x 0,5	6,7	41,7	66	24/20
37140AE4029908	special colored	4 x (2 x 0,25)D + 2 x 0,5	8,2	60,7	91	24/20
37140AE4029909	special colored	6 x 2 x 0,34 + 1 x (2 x 0,34)C + 2 x 1	9,4	107,8	134	22/22/18
37140CE4042A24	DIN 47100	4 x 2 x 0,25	7,2	38,7	64	24
37140AE4042A24	DIN 47100	4 x (2 x 0,25)CY	9,1	80,3	120	24
37140AE4042A22	DIN 47100	4 x (2 x 0,34)C	9,8	92,3	138	22
37140AE4082A22	DIN 47100	8 x (2 x 0,34)C	16,2	188	282	22
37140AE4029913	special colored	5 x (2 x 0,14)D + 2 x 0,5	8	49	73	26/20
37140AE4029914	acc. to SIEMENS standard	3 x (2 x 0,14)D2Y + 4 x 0,14 + 4 x 0,22 + 2 x 0,5	9,5	80,4	130	26/26/-/20
37140AE4029915	special colored	3 x (2 x 0,34)D12Y + 16 x 0,34	11,6	117,1	175	22/22
37140AE4029916	DIN 47100	4 x (2 x 0,5)C	9,9	123	184	20
37140AE4039917	special colored	3 x (2 x 0,14)D2Y + 2 x 0,5	8,6	57,7	86	26/20
37140CE405B927	DIN 47100	5x0,5+2x0,18	7,5	49	95	20/25

Sheath material TMPU acc. to DIN VDE 0282

Part no.	Color code	No. of cores x cross section n x mm ²	Outer Ø ca. mm ±10%	Copper weight kg/km	Cable weight approx. kg/km	AWG no.)*
37140AE4039919	special colored	3 x (2 x 0,14)D + 2 x (0,5)D	9	71,4	96	26/20
37140AE4029920	acc. to SIEMENS standard	3 x (2 x 0,14)D + 4 x 0,14 + 2 x 0,5	8,9	61	97	26/26/20
37140AE4029921	special colored	3 x (2 x 0,14)D + 4 x 0,14 + 4 x 0,22 + 2 x 0,5	9,5	79	111	26/26/-/20
37140AE4049922	special colored	4 x 2 x 0,38 + 4 x 0,5	8,9	76,3	106	-/20
37140AE4082923	DIN 47100	8 x 2 x 0,18	7,8	48	74	-
37140AE4029924	DIN 47100	12 x 0,22	6,9	42,5	63	-
37140AE4029925	acc. to SIEMENS standard	4 x (2 x 0,25)C12Y + (2 x 1)C12Y	13,2	-	-	24/18
37140AE4029926	special colored	3x(2x0,25)C+2x0,5	8,8	-	-	24/20
37140AE8039910	US4	3 x (2 x 0,14)D2Y + 2 x 0,5	8,6	57,5	89	26/20

Other dimension and colours available on request.

SERVO CABLES

GAALFLEX® SERVO T 840 C

paired PUR transmission cable with coloured cores and overall copper screen
acc.to SIEMENS standard 6FX8008 and SEW EURODRIVE standard



ELETTROTEK KABEL® GAALFLEX® SERVO T 840 C



Construction:

Conductor:	flexible tinned copper conductor Cl. 6 acc to IEC 60228, DIN VDE 0295
Insulation:	special polymer compound
Colour cores:	acc. to DIN 47100 as far as applicable
Stranding:	in layers + fillers
Wrapping:	plastic tape
Screen:	tinned copper braid
Outer sheath:	green (RAL 6018), PUR compound to UL 758

Resistance:



Self-extinguishing and flame retardant acc.to:
IEC 60332-1-2
EN 60332-1-2
UL CSA FT-1,FT-2



Oil resistance:
very good - PUR TMPU acc. to DIN VDE 0282
part.10+ HD 22.10



Halogen free acc.to:
DIN VDE 0472 part 815
IEC 60754-1

Technical data:

Nominal voltage:	max. 30 V UL/CSA: 30 V (SIEMENS) UL/CSA: 300 V (SEW EURODRIVE)
Test voltage:	1 kV
Temperature range	DIN VDE: UL: up to + 80°C
<i>Fixed laying:</i>	- 40°C up to + 80°C
<i>Flexible installation:</i>	- 35°C up to + 80°C
Radiation resistance:	5 x 10 ⁷ cj/kg
Min. bending radius	
<i>Fixed laying:</i>	5 x d
<i>Flexible installation:</i>	7 x d
<i>Continuously flexible:</i>	7 x d
Max speed (main application):	250 m/min

Features:

- UL AWM style 20236 80°C 30 V (SIEMENS)
- UL AWM style 20280 80°C 300 V (SEW EURODRIVE)
- good EMC characteristics
- flexible installation
- adhesion-free installation
- labs uncritical
- DESINA® colours
- good against acids, alkalines, solvents, hydraulic liquids etc.
- for SPEEDS and MINIMUM BENDING RADIUS
see pages from 2 to 8 of catalogue
- RoHS and CE approval



SIEMENS standard 6FX8008/6FX5008

Part no.	acc. to SIEMENS Standard	No.of cores x cross section n x mm ²	Outer-Ø ca.mm ± 10%	Copper weight kg/km	Cable weight approx. kg/km	AWG no.*)
37150AE4029901	6FX5008-1BA51	(3 x (2 x 0,14)D + 2 x 0,5 + 4 x 0,14 + 4 x 0,22)C	9,5	80,4	130	26/20/26/-
37150AE4029902	6FX5008-1BA41	3 x (2 x 0,14)D + 2 x 0,5 + 4 x 0,14)C	-	67,2	108	26/20/26

SEW EURODRIVE standard UL AWM style 20280 80 °C 300 V

Part no.	acc. to SEW EURODRIVE Standard	No.of cores x cross section n x mm ²	Outer-Ø ca.mm ± 10%	Copper weight kg/km	Cable weight approx. kg/km	AWG no.*)
37150CE4062A24	-	(6 x 2 x 0,25)C	9,4	59	105	24
37150CE4052A24	-	(5 x 2 x 0,25)C	8,8	51	91	24

Other dimension and colours available on request.

SERVO CABLES

FLEXIDRUM® T 300

TPE/PUR motor connection cable, 0,6/1 kV



ELETTROTEK KABEL® FLEXIDRUM® T 300

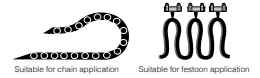

Construction:

Conductor:	flexible red copper conductor Cl. 6 acc to IEC 60228, DIN VDE 0295
Insulation:	special TPE compound
Colour cores:	black cores with consecutive numbers acc. to EN 50334 green-yellow from 3 cores
Stranding:	In layers + fillers
Wrapping:	non-woven tape
Outer sheath:	orange (RAL 2003), special PUR compound

Resistance:



Self-extinguishing and flame retardant acc.to:

DIN VDE 0482 part 265-2-1
EN 50265-2-1
IEC 60332-1-2
(equivalent DIN VDE 0472 part 804 test method B)



Oil resistance:

very good TMPU acc. to DIN VDE 0282 part 10
+ HD 22.10, acc. to DIN VDE 0473 part 811-2-1,
EN 60811-2-1
EC 60811-2-1



Halogen free acc.to:

DIN VDE 0472 part 815
IEC 60754-1

Technical data:

Nominal voltage:	U ₀ /U 0,6/1 kV
Test voltage:	4kV
Temperature range	
<i>Fixed laying:</i>	- 50°C up to + 90°C
<i>Flexible installation:</i>	- 40°C up to + 90°C
Radiation resistance:	5 x 10 ⁷ cj/kg
Min. bending radius	
<i>Fixed laying:</i>	4 x d
<i>Flexible installation:</i>	6 x d
<i>Continuously flexible:</i>	10 x d
Max speed (main application):	250 m/min

Features:

- very high flexible
- suitable for cable tracks
- oil resistant
- very long service life
- adhesion-free installation
- halogen-free
- labs uncritical
- flexible at low temperatures
- good against acids, alkalines, solvents, hydraulic liquids etc.
- for SPEEDS and MINIMUM BENDING RADIUS
see pages from 2 to 8 of catalogue

RoHS and CE approval



DESINA®

Part no.	No. of cores x cross section n x mm ²	Outer-Ø ca. mm ± 10%	Copper weight kg/km	Cable weight approx. kg/km	AWG no.*)
04130GG0041M15	4 G 1,5	8,5	57,6	102	16
04130GG0051M15	5 G 1,5	9,3	72	125	16
04130GG0041M25	4 G 2,5	10,7	96	160	14
04130GG0051M25	5 G 2,5	11,4	120	193	14
04130GG0041M40	4 G 4	12,4	153,6	247	12
04130GG0051M40	5 G 4	13,2	192	290	12
04130GG0041M60	4 G 6	15,1	230,4	351	10
04130GG0051M60	5 G 6	16,5	288	443	10
04130GG0041M61	4 G 10	17,5	384	552	8
04130GG0051M61	5 G 10	19,2	480	641	8
04130GG0041M62	4 G 16	21,2	614,4	796	6
04130GG0051M62	5 G 16	23,3	769	979	6
04130GG0041M63	4 G 25	24,3	960	1161	4
04130GG0051M63	5 G 25	26,8	1200	1433	4
04130GG0041M64	4 G 35	28,6	1344	1588	2
04130GG0041M65	4 G 50	32,3	1920	2212	1

Other dimension and colours available on request.

SERVO CABLES

FLEXIDRUM® T 300 C

TPE/PUR motor connection cable with overall copper screen, 0,6/1 kV



Construction:

Conductor:	flexible red copper conductor Cl. 6 acc to IEC 60228, DIN VDE 0295
Insulation:	special TPE compound
Colour cores:	black cores with consecutive numbers acc. to EN 50334 green-yellow from 3 cores
Stranding:	In layers + fillers
Wrapping:	PETP foil
Screen:	tinned copper braid
Wrapping:	non-woven tape
Outer sheath:	orange (RAL 2003), special PUR compound

Resistance:



Self-extinguishing and flame retardant acc.to:
DIN VDE 0482 part 265-2-1
EN 50265-2-1
IEC 60332-1-2
(equivalent DIN VDE 0472 part 804 test method B)



Oil resistance:
very good TPU acc. to DIN VDE 0282 part 10
+ HD 22.10, acc. to DIN VDE 0473 part 811-2-1,
EN 60811-2-1
EC 60811-2-1



Halogen free acc.to:
DIN VDE 0472 part 815
EN 50267-2-1
IEC 60754-1

Technical data:

Nominal voltage:	U _o /U 0,6/1 kV
Test voltage:	4kV core/screen: 2kV
Temperature range	
<i>Fixed laying:</i>	- 50°C up to + 90°C
<i>Flexible installation:</i>	- 40°C up to + 90°C
Radiation resistance:	5 x 10 ⁷ cJ/kg
Min. bending radius	
<i>Fixed laying:</i>	5 x d
<i>Flexible installation:</i>	10 x d
<i>Continuously flexible:</i>	12 x d
Max speed (main application):	250 m/min

Features:

- very high flexible
- suitable for cable tracks
- oil resistant
- very long service life
- adhesion-free installation
- halogen-free
- labs uncritical
- flexible at low temperatures
- good against acids, alkalines, solvents, hydraulic liquids etc.
- for SPEEDS and MINIMUM BENDING RADIUS
see pages from 2 to 8 of catalogue

RoHS and CE approval



DESINA®

Part no.	No. of cores x cross section n x mm ²	Outer-Ø ca. mm ± 10%	Copper weight kg/km	Cable weight approx. kg/km	AWG no. (*)
04140GG0041M15	4 G 1,5	9	95,8	141	16
04140GG0041M25	4 G 2,5	10,5	147	217	14
04140GG0041M40	4 G 4	12	210,2	289	12
04140GG0041M60	4 G 6	14,2	300,5	420	10
04140GG0041M61	4 G 10	18	489,9	627	8
04140GG0041M62	4 G 16	2	751,3	965	6
04140GG0041M63	4 G 25	25	1118,2	1363	4
04140GG0041M64	4 G 35	29	1533,4	1848	2
04140GG0041M65	4 G 50	34	2148,7	2553	1

Other dimension and colours available on request.

SERVO CABLES

FLEXIDRUM® T 310

TPE/PUR motor connection cable 0,6/1 kV, UL/CSA 1000 V

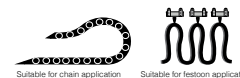

Construction:

Conductor:	flexible red copper conductor Cl. 6 acc to IEC 60228, DIN VDE 0295
Insulation:	special TPE compound
Colour cores:	black cores with consecutive numbers acc. to EN 50334 green-yellow from 3 cores
Stranding:	In layers + fillers
Wrapping:	non-woven tape
Outer sheath:	orange (RAL 2003), special PUR compound

Resistance:



Self-extinguishing and flame retardant acc.to:
DIN VDE 0482 part 265-2-1
EN 50265-2-1
IEC 60332-1-2



Oil resistance:
very good TPU acc. to DIN VDE 0282 part 10
+ HD 22.10, acc. to DIN VDE 0473 part 811-2-1,
EN 60811-2-1
EC 60811-2-1



Halogen free acc.to:
acc. to DIN VDE 0482, part 267
EN 50267-2-1 /
IEC 60754-1
(equivalent DIN VDE 0472 part 815)

Technical data:

Nominal voltage:	U ₀ /U 0,6/1 kV	UL/CSA: 1000 V
Test voltage:	4kV	
Temperature range	DIN VDE	UL/CSA: up to +80°C
<i>Fixed laying:</i>	- 50°C up to + 90°C	
<i>Flexible installation:</i>	- 40°C up to + 90°C	
Radiation resistance:	5 x 10 ⁷ cj/kg	
Min. bending radius		
<i>Fixed laying:</i>	4 x d	
<i>Flexible installation:</i>	6 x d	
<i>Continuously flexible:</i>	10 x d	
Max speed (main application):	250 m/min	

Features:

- AWM STYLE 21223 80°C 1000 V
CSA AWM I/II A/B 80°C 1000 V FT1 CE
- very high flexible
- suitable for cable tracks
- oil resistant
- very long service life
- adhesion-free installation
- halogen-free
- lamb uncritical
- flexible at low temperatures
- good against acids, alkalines, solvents, hydraulic liquids etc.
- very good weather resistant
- for SPEEDS and MINIMUM BENDING RADIUS
see pages from 2 to 8 of catalogue
- RoHS and CE approval



Part no.	No. of cores x cross section n x mm ²	Outer-Ø ca. mm ± 10%	Copper weight kg/km	Cable weight approx. kg/km	AWG no. (*)
04150HG0041A16	4 G 1,5	7,7	57,6	100	16
04150HG0041A14	4 G 2,5	9,3	96	149	14
04150HG0041A12	4 G 4	10,8	153,6	230	12
04150HG0041A10	4 G 6	12,9	230,4	334	10
04150HG0041A08	4 G 10	15,5	384	520	8
04150HG0041A06	4 G 16	18,8	614,4	806	6
04150HG0041A04	4 G 25	23,7	960	1245	4
04150HG0041A02	4 G 35	26,6	1344	1688	2
04150HG0041A01	4 G 50	31,8	1920	2381	1

Other dimension and colours available on request.

SERVO CABLES

GAALFLEX® SERVO T 833 C

TPE/PUR motor connection cable with overall copper screen

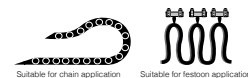

Construction:

Conductor:	flexible red copper conductor Cl. 6 acc to IEC 60228, DIN VDE 0295
Insulation:	special TPE compound
Colour cores:	black cores with consecutive numbers acc. to EN 50334 green-yellow from 3 cores
Stranding:	In layers + fillers
Wrapping:	non-woven tape
Screen:	tinned copper braid
Wrapping:	non-woven tape
Outer sheath:	orange (RAL 2003), special PUR compound

Resistance:



Oil resistance:
very good - oil-rating 60°C acc. to UL 758
CSA C22-2 NO 210 - 05

Technical data:

Nominal voltage:	U ₀ /U 0,6/1 kV UL/CSA 1000 V
Test voltage:	4kV core/screen: 2kV
Temperature range	DIN VDE UL/CSA: up to +80°C
<i>Fixed laying:</i>	- 50°C up to + 90°C
<i>Flexible installation:</i>	- 40°C up to + 90°C
Radiation resistance:	5 x 10 ⁷ cj/kg
Min. bending radius	
<i>Fixed laying:</i>	5 x d
<i>Flexible installation:</i>	10 x d
<i>Continuously flexible:</i>	12 x d
Max speed (main application):	250 m/min

Features:

UL AWM STYLE 20235 80°C 1000 V
CSA AWM I/II A/B 80°C 1000 V FT1 FT2 CE

very high flexibility
suitable for cable tracks
oil resistant
very long service life
adhesion-free installation
labs uncritical
flexible at low temperature
DESINA® colours

for SPEEDS and MINIMUM BENDING RADIUS
see pages from 2 to 8 of catalogue

RoHS and CE approval



DESINA®

Part no.	No. of cores x cross section n x mm ²	Outer-Ø ca. mm ± 10%	Copper weight kg/km	Cable weight approx. kg/km	AWG no. (*)
37070HG0041A16	4 G 1,5	9,1	83,5	126	16
37070HG0041A14	4 G 2,5	11	142,5	192	14
37070HG0041A12	4 G 4	12,5	206,7	273	12
37070HG0041A10	4 G 6	15,5	298,3	399	10
37070HG0041A08	4 G 10	17,8	495,2	605	8
37070HG0041A06	4 G 16	22,8	750	951	6
37070HG0041A04	4 G 25	25,7	1120	1331	4
37070HG0041A02	4 G 35	29,2	1534	1732	2
37070HG0041A01	4 G 50	34,3	2144	2428	1
37070HG0041A2C	4 G 70	42,5	3196	4600	2/0

Other dimension and colours available on request.

SERVO CABLES

GAALFLEX® SERVO T 834 C

TPE/PUR with overall copper screen, acc. to SIEMENS standard 6FX8008



ELETTROTEK KABEL® GAALFLEX® SERVO T 834 C

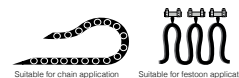

Construction:

Conductor:	flexible red copper conductor Cl. 6 acc to IEC 60228, DIN VDE 0295
Insulation:	special TPE compound
Colour cores:	black cores with consecutive numbers acc. to EN 50334 green-yellow from 3 cores 0,34 mm ² : acc. to DIN 47100
Stranding:	in layers + fillers
Wrapping:	non-woven tape
Screen:	tinned copper braid
Outer sheath:	orange (RAL 2003), PUR compound, acc. to UL 758

Resistance:



Self-extinguishing and flame retardant acc.to:

IEC 60332-1-2
EN 60332-1-2
UL CSA FT-1, FT-2



Oil resistance acc. to:

DIN VDE 0473 part 811-2-1,
IEC 60811-2-1



Halogen free acc.to:

IEC 60754-1
(equivalent DIN VDE 0472 part 815)

Technical data:

Nominal voltage:	U ₀ /U 0,6/1 kV	UL/CSA: 1000 V
Test voltage:	4 kV x 5 min 4 kV x 1 min	
Temperature range	DIN VDE	UL/CSA: up to +80°C
<i>Fixed laying:</i>	- 50°C up to + 90°C	
<i>Flexible installation:</i>	- 40°C up to + 90°C	
Radiation resistance:	5 x 10 ⁷ cJ/kg	
Min. bending radius		
<i>Fixed laying:</i>	5 x d	
<i>Flexible installation:</i>	7 x d	
<i>Continuously flexible:</i>	7 x d	
Max speed (main application):	300 m/min	

Features:

UL AWM style 21223 80°C, 1000V
CSA AWM I/II A/B 80°C 1000 V FT1 FT2
very high flexibility
oil resistant
very long service life
adhesion-free installation
labs uncritical
flexible at low temperature
DESINA® colours
for SPEEDS and MINIMUM BENDING RADIUS
see pages from 2 to 8 of catalogue
RoHS and CE approval



SIEMENS

Part no.	acc.to SIEMENS Standard	No.of cores x cross section n x mm ²	Outer-Ø ca.mm ± 10%	Copper weight kg/km	Cable weight approx. kg/km	AWG no.*)
37080HG0041A16	6FX8008-1BB11	4 G 1,5	9,1	83,5	126	16
37080HG0041A14	6FX8008-1BB21	4 G 2,5	11	142,5	192	14
37080HG0041A12	6FX8008-1BB31	4 G 4	12,5	206,7	273	12
37080HG0041A10	6FX8008-1BB41	4 G 6	15,5	298,3	399	10
37080HG0041A08	6FX8008-1BB51	4 G 10	17,8	495,2	605	8
37080HG0041A06	6FX8008-1BB61	4 G 16	22,8	750	951	6
37080HG0041A04	6FX8008-1BB25	4 G 25	25,7	1120	1331	4
37080HG0041A02	6FX8008-1BB35	4 G 35	29,2	1534	1732	2
37080HG0041A01	6FX8008-1BB50	4 G 50	34,3	2144	2428	1

Other dimension and colours available on request.

SERVO CABLES

GAALFLEX® SERVO T 841 C

paired TPE/PUR motor connection cable with overall copper screen



Construction:

Conductor:	flexible red copper conductor Cl. 6, acc. to IEC 60228, DIN VDE 0295 > 0,5 mm ² acc. to DIN VDE 0812
Insulation:	special TPE compound
Colour cores:	black cores with consecutive numbers acc. to EN 50334 green-yellow from 3 cores 0,34 mm² : acc. to DIN 47100 From Part n. 37090HG004B911: supply cores: black cores with consecutive numbers U1, V2, W3 and green-yellow from 3 cores control cores: black cores with consecutive numbers BR1 and BR2
Stranding:	control cores: (from 0,34 mm² up to 2,5 mm²): cores twisted in pairs
Screen:	pairs screened individually with aluminium tape + tinned copper braid
Wrapping:	pairs with PETP foil
Stranding:	supply cores and control cores together in layers
Wrapping:	non-woven tape
Screen:	tinned copper braid
Wrapping:	non-woven tape
Outer sheath:	orange (RAL 2003), PUR type TPU, acc. to DIN VDE 0282 part. 10 + HD 22.10

Resistance:



Self-extinguishing and flame retardant acc.to:
IEC 60332-1-2
EN 60332-1-2
UL CSA FT-1, FT-2



Oil resistance:
very good - TPU acc. to DIN VDE 0282 part.10 +
HD 22.10



Halogen free acc.to:
IEC 60754-1
(equivalent DIN VDE 0472 part 815)

Technical data:

Nominal voltage:	DIN VDE: supply cores Uo/U 0,6/1 kV UL/CSA: supply cores 1000 V DIN VDE: control cores 350 V UL/CSA: control cores 300 V
Test voltage:	supply cores: 4kV core screen: 1,5 kV
Temperature range	DIN VDE UL/CSA: up to +80°C
<i>Fixed laying:</i>	- 50°C up to + 90°C
<i>Flexible installation:</i>	- 40°C up to + 90°C
Radiation resistance:	5 x 10 ⁷ cj/kg
Min. bending radius	
<i>Fixed laying:</i>	5 x d
<i>Flexible installation:</i>	10 x d
<i>Continuously flexible:</i>	12 x d
Max speed (main application):	250 m/min

Features:

UL AWM STYLE 20235 80°C 1000 V
CSA AWM I/II A/B 80°C 300 V FT1 FT2 CE
very good EMC characteristics
long life service
adhesion-free installation
high flexibility
good against acids, alkalines, solvents, hydraulic liquids etc.
very good weather resistance
halogen-free
labs uncritical
flexible at low temperatures
mat surface outer sheath
DESINA® colours
for SPEEDS and MINIMUM BENDING RADIUS
see pages from 2 to 8 of catalogue
RoHS and CE approval



SERVO CABLES

GAALFLEX® SERVO T 84 I C

paired TPE/PUR motor connection cable with overall copper screen



DESINA® INDRAMAT

Part no.	No. of cores x cross section n x mm ²	Outer-Ø ca. mm ± 10%	Copper weight kg/km	Cable weight approx. kg/km	AWG no.*)
37090HG004B900	4 G 0,75 + 2 x (2 x 0,34)	11,6	117,1	168	19/22
37090HG004B901	4 G 1 + 2 x + (2 x 0,75)	11,8	150,1	201	18/19
37090HG004B902	4 G 1,5 + 2 x (2 x 0,75)	12,3	170,1	228	16/19
37090HG004B903	4 G 2,5 + 2 x (2 x 1)	14,5	231,8	320	14/18
37090HG004B904	4 G 4 + (2 x 1) + 2 x 1,5	17,4	343	458	12//18/16
37090HG004B905	4 G 6 + (2 x 1) + 2 x 1,5	18,9	432,8	557	10/18/16
37090HG004B906	4 G 10 + (2 x 1) + 2 x 1,5	20,4	603,7	736	8/18/16
37090HG004B907	4 G 16 + 2 x (2 x 1,5)	26	875,7	1111	6/16
37090HG004B908	4 G 25 + 2 x (2 x 1,5)	29,4	1251,1	1517	4/16
37090HG004B909	4 G 35 + 2 x (2 x 1,5)	31,3	1644,6	1882	2/16
37090HG004B910	4 G 50 + 2 x (2 x 2,5)	38,2	2317,6	2659	1/16

DESINA® SIEMENS

Part no.	No. of cores x cross section n x mm ²	Outer-Ø ca. mm ± 10%	Copper weight kg/km	Cable weight approx. kg/km	AWG no.*)
37090HG004B911	4 G 1,5 + (2 x 1)	11,9	148,2	-	16/18
37090HG004B912	4G 1,5 + (2 x 1,5)	12,5	159,2	222	16/16
37090HG004B913	4 G 2,5 + (2 x 1,5)	13,3	204,8	285	14/16
37090HG004B914	4 G 4 + (2 x 1,5)	15,2	268,8	369	12/16
37090HG004B915	4 G 6 + (2 x 1,5)	16,6	377,5	485	10/16
37090HG004B916	4 G 10 + (2 x 1,5)	19,5	555,8	677	8/16
37090HG004B917	4 G 16 + (2 x 1,5)	23,7	814,8	1019	6/16
37090HG004B918	4 G 25 + (2 x 1,5)	27,2	1175,6	1418	4/16
37090HG004B919	4 G 35 + (2x1,5)	30,1	1586,4	1810	2/16
37090HG004B920	4 G 50 + (2 x 1,5)	34,4	2192,4	2463	1/16

Other dimension and colours available on request.

SERVO CABLES

GAALFLEX® SERVO T 844 C

paired TPE/PUR with overall copper screen acc.to SIEMENS standard 6FX8008



Construction:

Conductor:	flexible red copper conductor Cl. 6, acc. to IEC 60228, DIN VDE 0295 > 0,5 mm ² acc. to DIN VDE 0812
Insulation:	special TPE compound
Power colour cores:	black cores with consecutive numbers acc. to EN 50334 green-yellow from 3 cores 0,34 mm² : acc. to DIN 47100
Signal colour cores:	
Pairs:	black and white
Multi pairs:	black and white numbered
Quads:	black, white, red, yellow
Stranding:	supply cores and control cores together in layers + fillers
Screen:	tinned copper braid
Wrapping:	plastic tape
Outer sheath:	orange (RAL 2003), PUR compound, acc. to UL 758

Resistance:



Self-extinguishing and flame retardant acc.to:
IEC 60332-1-2
EN 60332-1-2
UL CSA FT-1, FT-2



Oil resistance:
very good, acc. to internal standard, IEC 60811-2-1



Halogen free acc.to:
IEC 60754-1
(equivalent DIN VDE 0472 part 815)

Technical data:

Nominal voltage:	DIN VDE: supply cores U _o /U 0,6/1 kV UL/CSA: supply cores 1000 V DIN VDE: control cores 350 V UL/CSA: control cores 300 V
Test voltage:	supply cores: 4kV core screen: 1,5 kV
Temperature range	DIN VDE UL/CSA: up to +80°C
<i>Fixed laying:</i>	- 50°C up to + 90°C
<i>Flexible installation:</i>	- 40°C up to + 90°C
Radiation resistance:	5 x 10 ⁷ cj/kg
Min. bending radius	
<i>Fixed laying:</i>	5 x d
<i>Flexible installation:</i>	7 x d
<i>Continuously flexible:</i>	7 x d
Max speed (main application):	300 m/min

Features:

UL AWM style 21223 80°C, 1000V
CSA AWM I/II A/B 80°C 300 V FT1 FT2

very good EMC characteristics

long life service

adhesion-free installation

high flexibility

good against acids, alkalines, solvents, hydraulic liquids etc.

very good weather resistance

halogen-free

labs uncritical

flexible at low temperatures

DESINA® colours

for SPEEDS and MINIMUM BENDING RADIUS
see pages from 2 to 8 of catalogue

RoHS and CE approval



SERVO CABLES

GAALFLEX® SERVO T 844 C

paired TPE/PUR with overall copper screen acc.to SIEMENS standard 6FX8008



DESINA® INDRAMAT

Part no.	acc. to INDRAMAT Standard	No. of cores x cross section n x mm ²	Outer-Ø ca.mm ± 10%	Copper weight kg/km	Cable weight approx. kg/km	AWG no. *)
37100HG004B926	-	4x0,75+(2x0,5)StC	8,7	75,2	-	19/20
37100HG004B909	INK-0653	4 G 1 + 2 x (2 x 0,75)StC	11,8	148	260	18/19
37100HG004B910	INK-0650	4 G 1,5 + 2 x (2 x 0,75)StC	12,5	170	300	16/19
37100HG004B911	-	4 G 2,5 + 2 x (2 x 0,75)StC	-	-	-	14/19
37100HG004B912	INK-0602	4 G 2,5 + 2 x (2 x 1)StC	15	229	350	14/18
37100HG004B913	-	4 G 4 + 2 x (2 x 1)StC	16,5	312	480	12/18
37100HG004B914	INK-0603	4 G 4 + (2 x 1,5) StC + (2 x 1)StC	16,3	318	500	12/18
37100HG004B915	-	4 G 4 + 2 x (2 x 1,5)StC	17	324	505	12/16
37100HG004B916	-	4 G 6 + 2 x (2 x 1)StC	18,5	437	615	10/18
37100HG004B917	INK-0604	4 G 6 + (2 x 1,5)StC + (2 x 1)StC	19	445	630	10/16/18
37100HG004B918	-	4 G 6 + 2 x (2 x 1,5)StC	19,3	450	640	10/16
37100HG004B919	-	4 G 10 + 2 x (2 x 1)StC	21,8	609	920	8/18
37100HG004B920	INK-0605	4 G 10 + (2 x 1,5)StC + (2 x 1)StC	22,7	610	930	8/16/18
37100HG004B921	-	4 x 10 + 2 x (2 x 1,5)StC	22,7	625	940	8/16
37100HG004B922	INK-0606	4 x 16 + 2 x (2 x 1,5)StC	27,2	904	1240	6/16
37100HG004B923	INK-0607	4 x 25 + 2 x (2 x 1,5)StC	28,3	1323	1610	4/16
37100HG004B924	INK-0667	4 x 35 + 2 x (2 x 1,5)StC	32,8	1621	2220	2/16

DESINA® SIEMENS

Part no.	acc. to SIEMENS Standard	No. of cores x cross section n x mm ²	Outer-Ø ca.mm ± 10%	Copper weight kg/km	Cable weight approx. kg/km	AWG no. *)
37100HG004B900	6FX8008-1BA11	4 G 1,5 + (2 x 1,5)C	12	153	230	16/16
37100HG004B901	6FX8008-1BA21	4 G 2,5 + (2 x 1,5)C	13,5	193	285	14/16
37100HG004B902	6FX8008-1BA31	4 G 4 + (2 x 1,5)C	15	260	370	12/16
37100HG004B903	6FX8008-1BA41	4 G 6 + (2 x 1,5)C	17	355	480	10/16
37100HG004B904	6FX8008-1BA51	4 G 10 + (2 x 1,5)C	19,5	525	680	8/16
37100HG004B905	6FX8008-1BA61	4 G 16 + (2 x 1,5)C	22,5	800	1030	6/16
37100HG004B906	6FX8008-1BA25	4 G 25 + (2 x 1,5)C	26	1180	1400	4/16
37100HG004B907	6FX8008-1BA35	4 G 35 + (2 x 1,5)C	30	1585	1905	2/16
37100HG004B908	6FX8008-1BA50	4 x 50 + (2 x 1,5) C	34	2173	2525	1/16

Other dimension and colours available on request.



TORSION CABLES



TORSION CABLES

GAALFLEX® ROBOT 118

PUR torsion cable $\pm 360^\circ/1$ mt, max. 350 V (up to 0,34 mm²), 300/500 V (from 0,5 mm²)

ELETTROTEK KABEL® GAALFLEX® ROBOT 118



Construction:

Conductor:	from 0,14 mm² up to 0,34 mm²: flexible red copper conductor Cl. 5, acc. to IEC 60228, DIN VDE 0295 from 0,50 mm²: flexible red copper conductor Cl. 6, acc. to IEC 60228, DIN VDE 0295
Insulation:	special TPE compound
Colour cores:	up to 0,34 mm²: acc. to DIN 47100 from 0,50 mm²: acc. to DIN VDE 0293-308, HD 308 S2 from 6 cores black cores with consecutive numbers acc. to EN 50334; green-yellow earth-wire from 3 cores
Stranding:	in layers
Wrapping:	special separating foil
Outer sheath:	black (RAL 9005), special PUR compound

Resistance:



Flame retardant acc.to:
DIN VDE 0482 part 265-2-1,
EN 50265-2-1
IEC 60332-1



Oil resistance acc. to:
DIN VDE 0473 part. 811-2-1,
EN IEC 60811-2-1

Technical data:

Nominal voltage:	up to 0,34 mm²: 350 V (operating, peak voltage) from 0,5 mm²: 300/500 V
Test voltage:	up to 0,34 mm²: 1,5 kV x 5 min. above 0,5 mm²: 3 kV x 5 min.
Temperature range	
<i>Fixed laying:</i>	- 40°C up to + 80°C
<i>Flexible installation:</i>	- 30°C up to + 80°C
Min. bending radius:	7,5 x d
Torsion angle:	up to $\pm 360^\circ/1$ m (tested)

Features:

high abrasion resistance
UV resistance
oxygen and ozone resistance
RoHS and CE approval



TORSION CABLES

GAALFLEX® ROBOT 118

PUR torsion cable $\pm 360^\circ/1$ mt, max. 350V (up to 0,34 mm²), 300/500 V (from 0,5 mm²)

ELETTROTEK KABEL® GAALFLEX® ROBOT 118

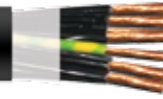

Part no.	No. of cores x cross section n x mm ²	Outer-Ø ca. mm ± 10%	Copper weight kg/km	Cable weight approx. kg/km	AWG no. *)
38030C74070M02	7 x 0,25	6	16,8	52	24
38030C74120M02	12 x 0,25	8	28,8	75	24
38030C74250M02	25 x 0,25	11	60	145	24
38030C74020M03	2 x 0,34	4,3	6,6	31	22
38030C74030M03	3 x 0,34	4,5	9,8	38	22
38030C74070M03	7 x 0,34	6	22,8	55	22
38030C74120M03	12 x 0,34	8,5	39,2	73	22
38030D72121M05	12 G 0,5	10,7	57,8	94	20
38030D72161M05	16 G 0,5	12	76,8	280	20
38030D72181M05	18 G 0,5	13	86,4	125	20
38030D72251M05	25 G 0,5	14,5	120	260	20
38030D72041M07	4 G 0,75	6,3	28,8	66	19
38030D72071M07	7 G 0,75	8,2	50,4	100	19
38030D72121M07	12 G 0,75	11,8	84,4	176	19
38030D72141M07	14 G 0,75	13	100,8	205	19
38030D74020M10	2 x 1	6,3	19,2	52	18
38030D72031M10	3 G 1	6,5	29	65	18
38030D72041M10	4 G 1	6,7	38,4	85	18
38030D72071M10	7 G 1	8,8	67,2	135	18
38030D72121M10	12 G 1	12,7	115,2	220	18
38030D72181M10	18 G 1	15,7	172,8	320	18
38030D72251M10	25 G 1	17,7	240	440	18
38030D72341M10	34 G 1	21,7	326,4	575	18
38030D72411M10	41 G 1	23,5	393,6	700	18
38030D72031M15	3 G 1,5	7,2	43,2	98	16
38030D72041M15	4 G 1,5	8,2	57,6	110	16
38030D72081M15	8 G 1,5	11,5	115,2	300	16
38030D72121M15	12 G 1,5	15,8	172,8	360	16
38030D72181M15	18 G 1,5	19,5	259,2	450	16
38030D72251M15	25 G 1,5	22,3	360	640	16
38030D72031M25	3 G 2,5	8,7	72	140	14
38030D72041M25	4 G 2,5	9,5	96	180	14
38030D72031M40	3 G 4	10,5	116	230	12
38030D72041M40	4 G 4	11,5	153,6	270	12
38030D72041M60	4 G 6	14,5	230,4	350	10
38030D72031M61	3 G 10	16	288	525	8
38030D72031M62	3 G 16	18,5	460,8	725	6
38030D72031M63	3 G 25	23,4	720	1185	4
38030D72031M64	3 G35	27	1008	1610	2

Other dimension and colours available on request.

TORSION CABLES

GAALFLEX® ROBOT 118 D

PUR torsion cable with overall copper screen $\pm 360^\circ$ / 1 mt, max. 350 V (up to 0,34 mm²), 300/500 V (from 0,5 mm²)

ELETTROTEK KABEL® GAALFLEX® ROBOT 118 D

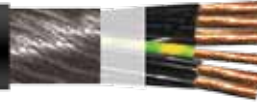

Construction:

- Conductor:** **from 0,14 mm² up to 0,34 mm²:**
flexible red copper conductor Cl. 5,
acc. to IEC 60228, DIN VDE 0295
from 0,50 mm²:
flexible red copper conductor Cl. 6,
acc. to IEC 60228, DIN VDE 0295
- Insulation:** special TPE compound
- Colour cores:** **up to 0,34 mm²:** acc. to DIN 47100
from 0,50 mm²: acc. to DIN VDE 0293-308,
HD 308 S2 from 6 cores black cores with
consecutive numbers acc. to EN 50334;
green-yellow earth-wire from 3 cores
- Stranding:** in layers
- Wrapping:** special separating foil
- Screen:** tinned copper wires helically wound
- Outer sheath:** black (RAL 9005), special PUR compound

Resistance:



Flame retardant acc.to:
DIN VDE 0482 part 265-2-1,
EN 50265-2-1
IEC 60332-1



Oil resistance acc. to:
DIN VDE 0473 part. 811-2-1,
EN IEC 60811-2-1

Technical data:

- Nominal voltage:** **up to 0,34 mm²:**
350 V (operating, peak voltage)
from 0,5 mm²:
300/500 V
- Test voltage:** **up to 0,34 mm²:**
1,5 kV x 5 min.
above 0,5 mm²:
3 kV x 5 min.
- Temperature range**
- Fixed laying:* - 40°C up to + 80°C
- Flexible installation:* - 30°C up to + 80°C
- Min. bending radius:** 7,5 x d
- Torsion angle:** up to $\pm 360^\circ$ /1 m (tested)

Features:

- high abrasion resistance
- UV resistance
- oxygen and ozone resistance
- RoHS and CE approval



Part no.	No. of cores x cross section n x mm ²	Outer-Ø ca. mm $\pm 10\%$	Copper weight kg/km	Cable weight approx. kg/km	AWG no.*)
38040C74100M01	10 x 0,14	8,2	34,2	68	26
38040C74120M01	12 x 0,14	8,4	42,1	100	26
38040C74180M01	18 x 0,14	10	54,5	126	26
38040C74250M01	25 x 0,14	11,2	69	162	26
38040C74120M02	12 x 0,25	8,6	59,5	134	24
38040C74180M02	18 x 0,25	10,5	80	169	24
38040C74250M02	25 x 0,25	11,5	103	221	24
38040C74120M03	12 x 0,34	9,2	78	169	22
38040C74180M03	18 x 0,34	11,3	101	218	22
38040C74250M03	25 x 0,34	12,5	158	312	22
38040D70121M05	12 G 0,5	11,6	117	182	20
38040D70251M05	25 G 0,5	15,3	255	356	20
38040D70121M07	12 G 0,75	12,5	155	228	19
38040D70181M07	18 G 0,75	15,5	210	313	19
38040D70251M07	25 G 0,75	17,1	275	421	19
38040D70121M10	12 G 1	13,5	190	272	18
38040D70181M10	18 G 1	16,6	245	397	18
38040D70251M10	25 G 1	18,6	345	547	18
38040D70121M15	12 G 1,5	16,9	260	352	16
38040D70181M15	18 G 1,5	20,7	370	493	16
38040D70251M15	25 G 1,5	22,9	498	719	16

Other dimension and colours available on request.

TORSION CABLES

GAALFLEX® ROBOT 113

PVC torsion cable ± 270°/0,5 mt, DIN VDE 300/500 V, UL 300 V, UL/CSA 600 V



ELETTROTEK KABEL® GAALFLEX® ROBOT 113



Construction:

Conductor:	from 0,14 mm² up to 0,34 mm²: flexible red copper conductor Cl. 6, acc. to IEC 60228, DIN VDE 0295 from 0,50 mm²: flexible red copper conductor Cl. 6, acc. to IEC 60228, DIN VDE 0295
Insulation:	PVC type Tl2 acc. to DIN VDE 0281 part. 1 + HD 21.1
Colour cores:	up to 0,34 mm²: acc.to US 2 from 0,50 mm²: black cores with consecutive numbers acc. to EN 50334 green-yellow from 3 cores
Stranding:	in layers
Wrapping:	netting tape over each layer and overall non-woven tape
Outer sheath:	black (RAL 9005), PVC type TM5, acc. to DIN VDE 0281 part. 1 HD 21.1

Resistance:



Fire performance 0,14 mm² - 0,34mm² acc. to:
UL VW1 IEC 60332-1-2 and EN 60332-1-2
Fire performance From 0,50 acc. to:
UL VW1 + CSA FT1 + FT2 and 60332-1-2



Oil resistance:
very good - TM5 acc. to DIN VDE 0281 part. 1 + HD
21.1 oil rating 60°C acc.to UL 758,
Fuel-Oil acc.to CSA C 22.2 No.210.2-M90

Technical data:

Voltage 0,14 mm ² - 0,34 mm ² :	UL: 300 V
Voltage from 0,50 mm ² :	UL: 600 V
Peak operating voltage 0,14 mm ² - 0,34 mm ² :	max 350 V
Nominal voltage: from 0,50 mm ² :	DIN VDE: 300/500V
Voltage 0,14 mm ² - 0,34 mm ² :	1,5 kV acc. to DIN VDE 0472 part. 509 core/screen 1,2 kV
Voltage from 0,50 mm ² :	2 kV acc. to DIN VDE 0281 part.2 + HD 21.2
Temperature range 0,14 mm ² - 0,34 mm ² :	UL DIN VDE
<i>Fixed laying:</i>	up to +80°C -40 up to +70°C
<i>Flexible application</i>	up to +80°C +5 up to +70°C
Temperature range from 0,50 mm ² :	UL DIN VDE
<i>Fixed laying:</i>	up to +90°C -40 up to +70°C
<i>Flexible application</i>	up to +90°C +5 up to +70°C
Min. bending radius:	continuously flexible 12 x d from 34 cores 20 x d

Features:

Rugged and reliable

AWM Style 21216 90°C 600 V
CSA AWM I/II A/B 90°C F 600 V FT1 FT2 CE

RoHS and CE approval



TORSION CABLES

GAALFLEX® ROBOT 113

PVC torsion cable $\pm 270^\circ/0,5$ mt, DIN VDE 300/500 V, UL 300 V, UL/CSA 600 V

ELETTROTEK KABEL® GAALFLEX® ROBOT 113

UL/CE

Part no.	No. of cores x cross section n x mm ²	Outer-Ø ca. mm ± 10%	Copper weight kg/km	Cable weight approx. kg/km	AWG no. *)
38010C76030A26	3 x 0,14	5,2	4	32	26
38010C76040A26	4 x 0,14	5,6	5,4	36	26
38010C76030A24	3 x 0,25	5,6	7,2	38	24
38010C76040A24	4 x 0,25	5,9	9,6	43	24
38010C76070A24	7 x 0,25	7,3	16,8	66	24
38010C76250A24	25 x 0,25	11,4	60	172	24
38010C76020A22	2 x 0,34	5,5	6,5	39	22

UL/CSA/CE

Part no.	No. of cores x cross section n x mm ²	Outer-Ø ca. mm ± 10%	Copper weight kg/km	Cable weight approx. kg/km	AWG no. *)
38010F70251A20	25 G 0,5	14,8	132	318	20
38010F70041A19	4 G 0,75	7,5	28,8	79	19
38010F70071A19	7 G 0,75	10,2	67,2	157	19
38010F70141A19	14 G 0,75	12,7	100,8	225	19
38010F70021A18	2 G 1	6,8	19,2	65	18
38010F70031A18	3 G 1	7,2	28,8	77	18
38010F70041A18	4 G 1	7,9	38,4	93	18
38010F70121A18	12 G 1	12,6	115,2	234	18
38010F70181A18	18 G 1	14,8	172,8	340	18
38010F70251A18	25 G 1	17,2	240	473	18
38010F70341A18	34 G 1	20,2	326,4	616	18
38010F70411A18	41 G 1	21,6	393,6	735	18
38010F70181A16	18 G 1,5	16,5	259,2	456	16
38010F70251A16	25 G 1,5	19,3	360	638	16
38010F70031A14	3 G 2,5	10,2	72	160	14
38010F70041A14	4 G 2,5	11,1	96	194	14
38010F70031A12	3 G 4	12,3	115,2	234	12
38010F70031A08	3 G 10	18,5	288	548	8
38010F70031A06	3 G 16	21,1	460,8	794	6
38010F70031A04	3 G 25	23,9	720	1128	4
38010F70031A02	3 G 35	28,9	1008	1555	2

Other dimension and colours available on request.

TORSION CABLES

GAALFLEX® ROBOT 113 D

PVC torsion cable $\pm 270^\circ/0,5$ mt, UL 300V



ELETTROTEK KABEL® GAALFLEX® ROBOT 113 D



Construction:

Conductor:	from 0,14 mm² up to 0,34 mm²: flexible red copper conductor Cl. 6, acc. to IEC 60228, DIN VDE 0295 from 0,50 mm²: flexible red copper conductor Cl. 6, acc. to IEC 60228, DIN VDE 0295
Insulation:	PVC type T12 acc. to DIN VDE 0281 part. 1 + HD 21.1
Colour cores:	acc. to US 2
Stranding:	in layers
Wrapping:	netting tape over each layer and overall non-woven tape
Screen:	tinned copper wires helically wound
Wrapping:	non-woven tape
Outer sheath:	black (RAL 9005), PVC type TM5, acc. to DIN VDE 0281 part. 1 HD 21.1

Resistance:



Fire performance acc. to:
UL VW1 IEC 60332-1-2 and EN 60332-1-2



Oil resistance:
very good - TM5 acc. to DIN VDE 0281 part. 1 +
HD 21.1

Technical data:

Voltage:	UL: 300 V	
Peak operating voltage:	max. 350 V	
Test voltage:	1,5 kV acc. to DIN VDE 0472 part. 509 core/screen 1,2 kV	
Temperature range	UL:	DIN VDE:
<i>Fixed laying:</i>	-up to +80°C	-40 up to +70°C
<i>Flexible installation:</i>	up to +80°C	+5 up to +70°C
Min. bending radius:	continuously flexible: 12 x d from 34 cores: 20 x d	
Torsion angle:	up to $\pm 270^\circ/0,5$ m (tested)	

Features:

Rugged and reliable

AWM Style 2464 80°C 300 V CE

RoHS and CE approval



Part no.	No. of cores x cross section n x mm ²	Outer-Ø ca. mm ± 10%	Copper weight kg/km	Cable weight approx. kg/km	AWG no. *)
38020C76120A26	12 x 0,14	8,8	32,2	85	26
38020C76250A24	25 x 0,25	12,0	96,7	187	24
38020C76041A08	4 G 10	19,6	468,2	-	8
38020C76041A06	4 G 16	23,4	742,5	-	6
38020C7604BA16	4 x 1,5 + (2 x 0,75)	11,6	119,9	-	16/19

Other dimension and colours available on request.

TORSION CABLES

GAALFLEX® ROBOT 123

PUR torsion cable $\pm 450^\circ/0,5$ mt, DIN VDE 300/500 V, UL/CSA 300 V (0,14 mm² - 0,34 mm²),
UL/CSA max. 600 V (from 0,5 mm²)



ELETTROTEK KABEL® GAALFLEX® ROBOT 123

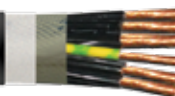

Construction:

Conductor:	from 0,14 mm² up to 0,34 mm²: flexible red copper conductor Cl. 6, acc. to IEC 60228, DIN VDE 0295 from 0,50 mm²: flexible red copper conductor Cl. 6, acc. to IEC 60228, DIN VDE 0295
Insulation:	TPE compound
Colour cores:	up to 0,34 mm²: acc.to US 2 from 0,50 mm²: black cores with consecutive numbers acc. to EN 50334 green-yellow from 3 cores
Stranding:	in layers
Wrapping:	netting tape over each layer and overall non-woven tape
Outer sheath:	black (RAL 9005), PUR type TMPU, acc.to DIN VDE 0282 part 10 + HD 22.1

Resistance:



Fire performance From 0,50 acc. to:
UL VW1 + CSA FT1 + FT2, IEC 60332-1-2



Halogen free acc. to:
DIN VDE 0472 part 815 + IEC 60754-1



Oil resistance:
very good-PUR TMPU acc.to DIN VDE 0282 part 10
+ HD 22.10

Technical data:

Voltage 0,14 mm ² - 0,34 mm ² :	UL/CSA: 300 V
Voltage from 0,50 mm ² :	UL/CSA: max 600 V
Peak operating voltage 0,14 mm ² - 0,34 mm ² :	max 350 V
Nominal voltage: from 0,50 mm ² :	DIN VDE: 300/500V
Test Voltage 0,14 mm ² - 0,34 mm ² :	1,5 kV acc. to DIN VDE 0472 part. 509
Test Voltage from 0,50 mm ² :	3 kV acc. to DIN VDE 0281 part.2 + HD 21.2
Temperature range	UL/CSA: DIN VDE
<i>Fixed laying:</i>	up to +80°C - 50 up to +90°C
<i>Flexible application</i>	up to +80°C - 40 up to +90°C
Min. bending radius:	continuously flexible: 12 x d from 34 cores: 20 x d
Torsion angle:	up to $\pm 450^\circ/0,5$ m (tested)

Features:

Rugged and reliable

UL AWM Style 21060 80°C 600 V
CSA AWM I/II A/B 80°C F 600 V FT1 FT2 CE

good against acids, alkalines, solvents,hydraulic liquids etc.

RoHS and CE approval



TORSION CABLES

GAALFLEX® ROBOT 123

PUR torsion cable $\pm 450^\circ/0,5$ mt, DIN VDE 300/500 V, UL/CSA 300 V (0,14 mm² - 0,34 mm²),
UL/CSA max. 600 V (from 0,5 mm²)



ELETTROTEK KABEL® GAALFLEX® ROBOT 123

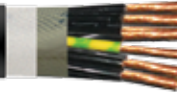

UL/CSA/CE

Part no.	No. of cores x cross section n x mm ²	Outer-Ø ca. mm ± 10%	Copper weight kg/km	Cable weight approx. kg/km	AWG no. (*)
38050C76030A26	3 x 0,14	5,5	4,0	31	26
38050C76040A26	4 x 0,14	5,7	5,4	34	26
38050C76030A24	3 x 0,25	5,8	7,2	37	24
38050C76040A24	4 x 0,25	6,1	9,6	41	24
38050C76070A24	7 x 0,25	7,2	16,8	60	24
38050C76250A24	25 x 0,25	10,7	60,0	144	24
38050C76020A22	2 x 0,34	5,8	6,5	38	22
38050F70181A20	18 G 0,5	12,5	95	205	20
38050F70251A20	25 G 0,5	14,7	132	287	20
38050F70041A19	4 G 0,75	8,0	28,8	79	19
38050F70141A19	14 G 0,75	12,6	100,8	204	19
38050F70021A18	2 G 1	7,5	19,2	68	18
38050F70031A18	3 G 1	7,8	28,8	78	18
38050F70041A18	4 G 1	8,4	38,4	93	18
38050F70061A18	6 G 1	9,7	57,6	129	18
38050F70071A18	7 G 1	10,3	67,2	147	18
38050F70121A18	12 G 1	12,6	115,2	217	18
38050F70181A18	18 G 1	14,9	172,8	318	18
38050F70251A18	25 G 1	17,2	240	437	18
38050F70341A18	34 G 1	20	326,4	564	18
38050F70401A18	40 G 1	21,4	384	661	18
38050F70411A18	41 G 1	21,4	393,6	673	18
38050F70071A16	7 G 1,5	11,7	100,8	200	16
38050F70121A16	12 G 1,5	14,7	172,8	307	16
38050F70181A16	18 G 1,5	17,1	259,2	442	16
38050F70251A16	25 G 1,5	20	360	618	16
38050F70031A14	3 G 2,5	10,4	72	151	14
38050F70041A14	4 G 2,5	11,2	96	182	14
38050F70031A12	3 G 4	12,1	115,2	211	12
38050F70031A08	3G 10	18	288	475	8
38050F70031A06	3 G 16	20,4	460,8	698	6
38050F70031A04	3 G 25	25,6	720	1066	4
38050F70031A02	3 G 35	28,4	1008	1386	2

Other dimension and colours available on request.

OTHER SPECIAL CONSTRUCTION ON STOCK

Part no.	No. of cores x cross section n x mm ²	Outer-Ø ca. mm ± 10%	Copper weight kg/km	Cable weight approx. kg/km	AWG no. (*)
38050C76250A22	25 x 0,34	10,5	81,6	191,8	22
38050F70029002	2 x 0,5 + 27 x 0,75	12,7	149,4	149,4	20/19

TORSION CABLES

GAALFLEX® ROBOT 123 D

PUR torsion cable $\pm 450^\circ/0,5$ mt, DIN VDE 300/500 V, UL/CSA 300 V (0,14 mm² - 0,34 mm²),
UL/CSA 600 V (from 0,5 mm²)



ELETTROTEK KABEL® GAALFLEX® ROBOT 123 D

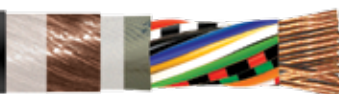

Construction:

Conductor:	from 0,14 mm² up to 0,34 mm²: flexible red copper conductor Cl. 6, acc. to IEC 60228, DIN VDE 0295 from 0,50 mm²: flexible red copper conductor Cl. 6, acc. to IEC 60228, DIN VDE 0295
Insulation:	TPE compound
Colour cores:	from 0,14 mm² up to 0,34 mm²: acc.to US 2 from 0,50 mm²: black cores with consecutive numbers acc. to EN 50334 green-yellow from 3 cores
Stranding:	in layers
Wrapping:	netting tape over each layer and overall non-woven tape
Screen:	bare copper wires helically wound
Wrapping:	non-woven tape
Outer sheath:	black (RAL 9005), PUR type TMPU, acc.to DIN VDE 0282 part 10 + HD 22.

Resistance:



Fire performance acc. to:
UL VW1 + CSA FT1 + FT2, IEC 60332-1-2



Halogen free acc. to:
DIN VDE 0472 part 815 + IEC 60754-1



Oil resistance:
very good-PUR TMPU acc.to DIN VDE 0282 part 10
+ HD 22.10

Technical data:

Voltage 0,14 mm ² - 0,34 mm ² :	UL/CSA: 300 V
Voltage from 0,50 mm ² :	UL/CSA: max 600 V
Peak operating voltage 0,14 mm ² - 0,34 mm ² :	max 350 V
Nominal voltage: from 0,50 mm ² :	DIN VDE: 300/500V
Test Voltage 0,14 mm ² - 0,34 mm ² :	1,5 kV acc. to DIN VDE 0472 part. 509
Test Voltage from 0,50 mm ² :	3 kV acc. to DIN VDE 0281 part.2 + HD 21.2
Temperature range	UL/CSA: up to +80°C DIN VDE - 50 up to +90°C Fixed laying: up to +80°C Flexible application: - 40 up to +90°C
Min. bending radius:	continuously flexible: 12 x d from 34 cores: 20 x d
Torsion angle:	up to $\pm 450^\circ/0,5$ m (tested)

Features:

Rugged and reliable

AWM Style 21060 80°C 600 V
CSA AWM I/II A/B 80°C F 600 V FT1 FT2 CE

good against acids, alkalines, solvents/hydraulic liquids etc.

RoHS and CE approval



TORSION CABLES

GAALFLEX® ROBOT 123 D

PUR torsion cable $\pm 450^\circ/0,5$ mt, DIN VDE 300/500 V, UL/CSA 300 V (0,14 mm² - 0,34 mm²),
UL/CSA 600 V (from 0,5 mm²)



ELETTROTEK KABEL® GAALFLEX® ROBOT 123 D



UL/CSA/CE

Part no.	No. of cores x cross section n x mm ²	Outer-Ø ca. mm ± 10%	Copper weight kg/km	Cable weight approx. kg/km	AWG no. *)
38060C76120A26	12 x 0,14	8,5	30,2	79	26
38060C76250A24	25 x 0,25	11,3	90,9	171	24
38060F70051A24	5 G 0,5	8,7	40,5	95	20
38060F70121A16	12 G 1,5	15,3	214,7	344	16
38060F70181A16	18 G 1,5	17,8	326	499	16

Other dimension and colours available on request.

OTHER SPECIAL CONSTRUCTION ON STOCK

Part no.	No. of cores x cross section n x mm ²	Outer-Ø ca. mm ± 10%	Copper weight kg/km	Cable weight approx. kg/km	AWG no. *)
38060F70041A14	4 G 2,5	11,9	127,1	-	14
38060F70041A12	4 G 4	13,4	193,2	-	12
38060F70031A06	3 G 16	20,2	539,2	-	6
38060C77042A22	4 x (2 x 0,34)D11Y	11,0	47,3	126	22
38060C76020A24	2 x (1 x 0,25)	7,0	11,7	48,3	24
38060F7L010A04	1 x 25	11,8	271,5	334	4
38060C76161A16	16 x 0,34	9,4	69,3	-	22
38060F7004BA16	4 G 1,5 + (2 x 1)	12,3	126	-	16
38060C76042A22	(4 x (2 x 0,34)D11Y)	13,1	215,5	282	22
38060C76052A22	5 x (2 x 0,34)	14,1	114,8	-	22



PROFIBUS DP CABLES

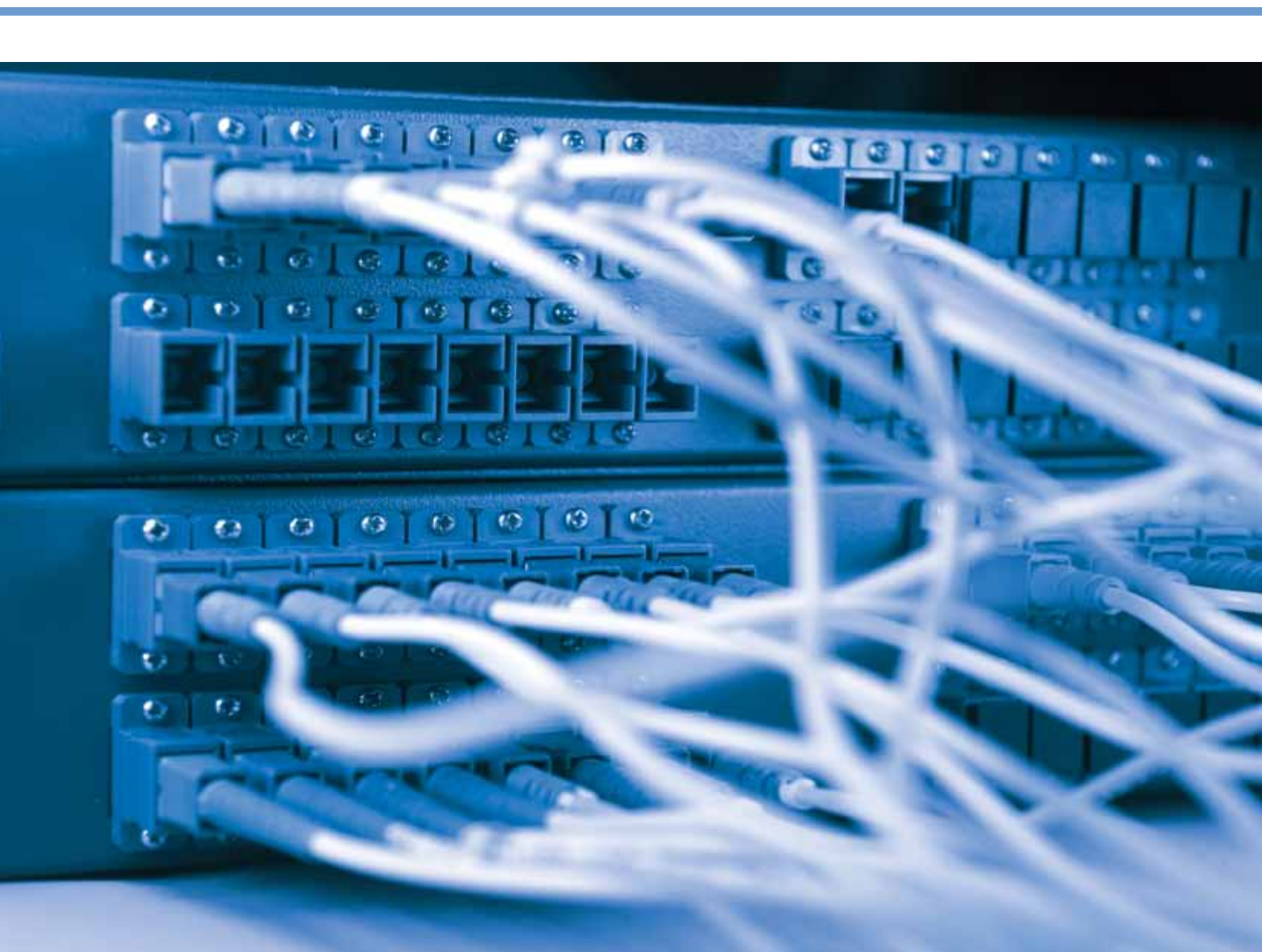



PROFIBUS 637 UL approval

ELETTROTEK KABEL® PROFIBUS 637

Construction:

Conductor:	solid (39141) or stranded (39140) red copper conductor 7x0,25 mm -22/7 AWG
Insulation:	special PE compound acc. to DIN VDE 0819 part 103
Colour cores:	red, green
Stranding:	in layers
Screen:	aluminium tape and tinned copper braid
Outer sheath:	violet (RAL 4001 or 4005), PVC oil resistant compound, acc. to DIN VDE 0281 part 1

Resistance:



Self-extinguishing and flame retardant acc.to:
IEC 60332-1-2
EN 60332-1-2



Oil resistance acc. to:
DIN VDE 0281 part 1
DIN VDE 0473 part.811-2-1
DIN VDE 0207 part. 5



UV resistance acc.to:
UL1581 §1200 Std.

Technical data:

Peak operating voltage:	max. 350 V
UL Voltage:	(PROFIBUS 637): 300 V
Test voltage:	1,5 kV
Temperature range	(PROFIBUS 637): UL: up to +80°C
<i>Fixed laying:</i>	-30°C up to +80°C
<i>Flexible installation:</i>	-5°C up to +80°C
Min. bending radius:	12 x d
Characteristic impedance 3-20 MHz:	150 Ω ± 10%

Features:

UL style: AWM style 2571 80°C 300V

RoHS and CE approval



Part no.	No.of cores x cross section n x mm ²	Outer-Ø ca.mm ± 10%	Copper weight kg/km	Cable weight approx. kg/km	AWG no.*)
39140CVB020A22	2 x 0,34	7,3	23,8	53	22
39141CVB020A22	2 x 0,34	7,3	23,8	53	22

PROFIBUS 632



ELETTROTEK KABEL® PROFIBUS 632

Construction:

Conductor:	0,34 mm²: stranded red copper conductor acc. to DIN VDE 0812 1,00 mm²: Flexible red copper conductor Cl. 5, acc to IEC 60228, DIN VDE 0295
Insulation:	0,34 mm²: special PE compound, acc. to DIN VDE 0819 part 103 1 mm²: PVC type TI2, acc. to DIN VDE 0281 part 1
Colour cores:	0,34 mm²: red, green 1 mm²: brown, light blue and green-yellow
Stranding:	in layers
Screen:	aluminium tape + PETP foil and tinned copper braid
Outer sheath:	violet (RAL 4001 or 4005), PVC type TM1 acc. to DIN VDE 0281 part 1

Resistance:



Self-extinguishing and flame retardant acc.to:
IEC 60332-1-2
EN 60332-1-2

Technical data:

Peak operating voltage:	max. 350 V
Test voltage:	1,5 kV
Temperature range	
<i>Fixed laying:</i>	-30°C up to +70°C
<i>Flexible installation:</i>	-5°C up to +70°C
Min. bending radius:	12 x d
Characteristic impedance 3-20 MHz:	150 Ω ± 10%

Part no.	No.of cores x cross section n x mm ²	Outer-Ø ca.mm ± 10%	Copper weight kg/km	Cable weight approx. kg/km	AWG no.*)
39110CVB020M03	2 x 0,34	7,5	25,8	56	22
39110CV4027M10	2 x 0,34 + 3 x 1,00	10,1	58,8	122	22/18

PROFIBUS DP CABLES

PROFIBUS 630 PROFIBUS 631 PE halogen-free



ELETTROTEK KABEL® PROFIBUS 630

Construction:

Conductor:	solid red copper conductor 1x0,34 mm ² - 22AWG
Insulation:	special PE compound acc. to DIN VDE 0819 part 103
Colour cores:	red, green
Stranding:	in layers
Screen:	aluminium tape and tinned copper braid
Outer sheath:	(PROFIBUS 630): violet (RAL 4001 or 4005), PVC type TM1 acc. to DIN VDE 0281 part 1 (PROFIBUS 631 PE): violet (RAL 4001 or 4005), PE type 2YM1 acc.to DIN VDE 0207 part 3

Technical data:

Peak operating voltage:	max. 350 V
Test voltage:	1,5 kV
Temperature range	(PROFIBUS 630):
<i>Fixed laying:</i>	-30°C up to +70°C
<i>Flexible installation:</i>	-5°C up to +70°C
Temperature range	(PROFIBUS 631 PE):
<i>Fixed laying:</i>	-40°C up to +70°C
<i>Flexible installation:</i>	-40°C up to +70°C
Min. bending radius:	12 x d
Radiation resistance:	(PROFIBUS 630): 8 x 10 ⁷ cJ/kg (PROFIBUS 631 PE): 7 x 10 ⁶ cJ/kg
Characteristic impedance 3-20 MHz:	150 Ω ± 10%

Resistance:



Self-extinguishing and flame retardant acc.to:
IEC 60332-1-2
EN 60332-1-2
(PROFIBUS 630)



Oil resistance acc. to:
DIN VDE 0473 part.811-2-1
IEC EN 60811-2-1
(PROFIBUS 630)



Halogen-free acc. to:
DIN VDE 0472 part 815 + IEC60754-1
(PROFIBUS 631 PE)



Corrosiveness of conflagration gases:
in compliance with IEC 60754-2
and EN 50267-2-2 + VDE 0482 part 267-2-2
no development of corrosive conflagration gases

Features:

RoHS and CE approval



Part no.	No. of cores x cross section n x mm ²	Outer-Ø ca.mm ± 10%	Copper weight kg/km	Cable weight approx. kg/km	AWG no.)*
39070CVB020M03	2 x 0,34	7,1	23,8	49	22
39100CVB020M03	2 x 0,34	7,1	23,8	44	22

PROFIBUS DP CABLES

PROFIBUS 630 halogen-free
PROFIBUS 630 FRNC halogen-free



ELETTROTEK KABEL® PROFIBUS 630 FRNC

Construction:

Conductor: stranded red copper conductor acc. to DIN VDE 0812

Insulation: special PE compound acc. to DIN VDE 0819 part 103

Colour cores: red, green

Stranding: in layers

Screen: aluminium tape and tinned copper braid

Outer sheath: **(PROFIBUS 630):** violet (RAL 4001 or 4005), halogen free compound
(PROFIBUS 630 FRNC): violet (RAL 4001 or 4005), halogen free compound

Resistance:



no flame propagation acc.to: IEC 60332-3C + EN 60332-3C
flame retardant and self-extinguishing acc.to: IEC 60332-1-2 and EN 60332-1-2
(PROFIBUS 630 FRNC)



Oil resistance acc. to: DIN VDE 0473 part.811-2-1
 IEC EN 60811-2-1
(PROFIBUS 630)



Halogen-free acc. to: DIN VDE 0472 part 815 + IEC60754-1



Corrosiveness of conflagration gases: in compliance with IEC 60754-2 and EN 50267-2-2 + VDE 0482 part 267-2-2
 no development of corrosive conflagration gases

Technical data:

Peak operating voltage: max. 350 V

Test voltage: 1,5 kV

Temperature range (PROFIBUS 630):
Fixed laying: -40/+80°C
Flexible installation: -40/+80°C

Temperature range (PROFIBUS 630 FRNC):
Fixed laying: -40/+80°C
Flexible installation: -30/+80°C

Min. bending radius: 12 x d

Radiation resistance (PROFIBUS 630): 5 x 10⁸ cJ/kg

Characteristic impedance 3-20 MHz: 150 Ω ± 10%

Features:

RoHS and CE approval



Part no.	No. of cores x cross section n x mm ²	Outer-Ø ca.mm ± 10%	Copper weight kg/km	Cable weight approx. kg/km	AWG no.)*
39080CVB020M03	2 x 0,34	7,5	30,4	50	22
39090CVB020M03	2 x 0,34	7,5	30,4	62	22

PROFIBUS DP CABLES

PROFIBUS 633 PE halogen-free, flexible SPECIAL PROFIBUS 633



ELETTROTEK KABEL® PROFIBUS 633

Construction:

- Conductor:** **0,34 mm²:** stranded red copper conductor acc. to DIN VDE 0812
1,00 mm²: Flexible red copper conductor Cl. 5, acc to IEC 60228, DIN VDE 0295
- Insulation:** **0,34 mm²:** special PE compound, acc. to DIN VDE 0819 part 103
1 mm²: special PE compound, acc. to DIN VDE 0207 part 2
- Colour cores:** **0,34 mm²:** red, green
1 mm²: brown, light blue and green-yellow
- Stranding:** in layers
- Screen:** aluminium tape + PETP foil and tinned copper braid
- Outer sheath:** **(PROFIBUS 633 PE):**
violet (RAL 4001 or 4005), special PE compound acc. to DIN VDE 0207 part 3
(SPECIAL PROFIBUS 633):
violet (RAL 4001 or 4005), FRNC compound

Resistance:



Self-extinguishing and flame retardant acc.to:
IEC 60332-1-2
IEC 60332-3-22
(SPECIAL PROFIBUS 633)



Halogen-free acc. to:
DIN VDE 0472 part 815 + IEC60754-1
(PROFIBUS 633 PE)



Corrosiveness of conflagration gases:
in compliance with IEC 60754-2
and EN 50267-2-2 + VDE 0482 part 267-2-2
no development of corrosive conflagration gases
(PROFIBUS 633 PE)



Oil resistance acc. to:
IEC 60811-2-1
(SPECIAL PROFIBUS 633)

Technical data:

- Peak operating voltage:** max. 350 V
- Test voltage:** 1,5 kV
- Temperature range (PROFIBUS 633 PE):**
Fixed laying: -40°C up to +70°C
Flexible installation: -5°C up to +70°C
- Temperature range (SPECIAL PROFIBUS 633):**
Fixed laying: -25°C up to +80°C
Flexible installation: -5°C up to +80°C
- Min. bending radius:** 12 x d
- Characteristic impedance 3-20 MHz:** 150 Ω ± 10%

Special Profibus 633 Approvals:

Germanischer Lloyd
Lloyds Register
Bureau Veritas
ABS
Det Noske Veritas
RoHS and CE approval



Part no.	No.of cores x cross section n x mm ²	Outer-Ø ca.mm ± 10%	Copper weight kg/km	Cable weight approx. kg/km	AWG no.®)
39120CVB020M03	2 x 0,34	7,5	25,8	50	22
39120CV4027M10	2 x 0,34 + 3 x 1,00	10,1	58,8	101	22/18
39128CVB020M03	2 x 0,34	8	25,8	84	22

PROFIBUS 642



ELETTROTEK KABEL® PROFIBUS 642

Construction:

Conductor:	stranded red copper conductor acc. to DIN VDE 0812
Insulation:	special PE compound acc. to DIN VDE 0819 part 103
Colour cores:	(PA) red, green (Type B) acc to DIN 47100
Stranding:	in layers
Wrapping:	PETP foil
Screen:	tinned copper braid
Outer sheath:	violet (RAL 4001 or 4005), blue (RAL 5015) or black (RAL 9005) (2 x 0,82 mm ²) PVC type TM1 acc. to DIN VDE 0281 part 1

Resistance:



Oil resistance acc. to:
DIN VDE 0281 part 1
DIN VDE 0473 part.811-2-1, IEC 60811-2-1

Technical data:

Peak operating voltage:	max. 350 V
Test voltage:	1,5 kV
Temperature range	
<i>Fixed laying:</i>	-30°C up to +70°C
<i>Flexible installation:</i>	-5°C up to +70°C
Min. bending radius:	7,5 x d
Characteristic impedance 3-20 MHz:	PA: at 31.25 kHz 100 Ω ± 20% Typ B: at > 100 kHz 100 Ω - 130 Ω PA: at 31.25 kHz 100 Ω ± 20%

Features:

RoHS and CE approval



Part no.	No. of cores x cross section n x mm ²	Outer-Ø ca. mm ± 10%	Copper weight kg/km	Cable weight approx. kg/km	AWG no. (*)
39160CVB020M22	2 x 0,22	4,4	14,7	26	24
39160CV4022M22	2 x 2 x 0,22	6,2	22,4	45	24
39160CVB020M02	2 x 0,25	4,9	15,4	30	24
39160CV4022M02	2 x 2 x 0,25	6,7	26,5	52	19
39160C7B020M08	2 x 0,82	7,3	38,1	68	19
39160CBB020M08	2 x 0,82	7,3	38,1	68	19

PROFIBUS DP CABLES

SPECIAL PROFIBUS 634, for cable tracks



ELETTROTEK KABEL® SPECIAL PROFIBUS 634



Construction:

Conductor:	0,34 mm²: stranded red copper conductor acc. to DIN VDE 0812 1 mm²: flexible red copper conductor Cl. 6, acc to IEC 60228, DIN VDE 0295
Insulation:	0,34 mm²: special PE compound acc. to DIN VDE 0819 part 103 1 mm²: special TPE compound
Colour cores:	0,34 mm²: red, green 1 mm²: brown, light blue and green/yellow
Stranding:	in layers
Screen:	2x0,34 mm²: pair screened and wrapped individually with non-woven tape/aluminium tape/ non-woven tape and tinned copper braid
Inner sheath:	2x0,34 mm²: pair special TPE compound
Outer sheath:	violet (RAL 4001 or 4005), PUR type TMPU acc. to, DIN VDE 0282 part 10 (rough surface)

Resistance:



Oil resistance acc. to:
DIN VDE 0282 part 10 + HD 22.10



Halogen-free acc. to:
DIN VDE 0472 part 815+IEC60754-1



Corrosiveness of conflagration gases:
in compliance with IEC 60754-2
and EN 50267-2-2 + VDE 0482 part 267-2-2

Technical data:

Peak operating voltage:	max. 350 V
Test voltage:	1,5 kV
Temperature range	
<i>Fixed laying:</i>	- 40°C up to +80°C
<i>Flexible installation:</i>	- 40°C up to +80°C
Min. bending radius:	
<i>Fixed laying:</i>	10 x d
<i>Flexible installation:</i>	12 x d
Radiation resistance:	5 x 10 ⁶ cJ/kg
Max speed (main application):	250 m/min
Characteristic impedance 3-20 MHz:	150 Ω ± 10%

Features:

for SPEED and MINIMUM BENDING RADIUS
see pages from 2 to 8 of catalogue

RoHS and CE approval



Part no.	No. of cores x cross section n x mm ²	Outer-Ø ca. mm ± 10%	Copper weight kg/km	Cable weight approx. kg/km	AWG no. (*)
39170CVB020M03	2x0,34	7,6	30,9	58	22
39170CV403BM10	2x0,34+3x1	10,2	58,8	108	22/18

PROFIBUS DP CABLES

SPECIAL PROFIBUS 634 UL, UL approval, for cable tracks



ELETTROTEK KABEL® SPECIAL PROFIBUS 634 UL

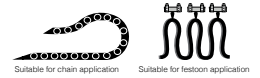

Construction:

Conductor:	0,34 mm²: flexible red copper conductor, 19x0,16 mm - 22/19 AWG acc. to DIN VDE 0812 0,75 mm²: flexible red copper conductor Cl. 6, acc to IEC 60228, DIN VDE 0295 42x0,15 mm - AWG 19/42
Insulation:	0,34 mm²: special PE compound 0,75 mm²: special PP compound
Colour cores:	0,34 mm²: red, green 0,75 mm²: brown, light blue and green-yellow
Stranding:	0,34 mm²: in pair + PE fillers 0,75 mm²: In layers + fillers
Screen:	0,34 mm²: aluminium tape + PETP foil and tinned copper braid
Wrapping:	0,34 mm²: non-woven tape 0,75 mm²: non-woven tape
Outer sheath:	violet (RAL 4001 or 4005), PUR compound

Technical data:

Peak operating voltage:	max. 350 V
Voltage UL	300 V
Test voltage:	1,5 kV
Temperature range	- 40°C up to + 80°C
Min. bending radius:	
<i>Fixed laying:</i>	10 x d
<i>Flexible installation:</i>	15 x d
Max speed (main application):	250 m/min

Resistance:

	Self-extinguishing and flame retardant acc.to: UL 1581 1061, IEC 60332-1-2 EN 60332-1-2
	Oil resistance acc. to: IEC 60811-2-1 ICEA S-82-552 and ASTM oil 1
	Halogen-free acc. to: IEC 60754-1 EN 50267-2-1
	Corrosiveness of conflagration gases: in compliance with IEC 60754-2 and EN 50267-2-2 + VDE 0482 part 267-2-2 no development of corrosive conflagration gases
	UV resistance acc.to: UL1581 §1200 Std.

Features:

AWM style 10493 - 20233 80°C 300 V
for SPEED and MINIMUM BENDING RADIUS
see pages from 2 to 8 of catalogue
RoHS and CE approval



Electrical and Transmission proprieties at 20°C PROFIBUS UL

Profinet bus

Max. DC cond. resistance	59,4 Ω x km
Max. capacitance at 800 Hz	30 nF/km
Impedance at 800 1-20 MHz	150 Ω (± 10%)
Max. attenuation at 9,6 kHz	4,2 dB/km
Max. attenuation at 38,4 kHz	5,2 dB/km
Max. attenuation at 4 MHz	2,3 dB/km
Max. attenuation at 16 MHz	44,0 dB/km
Dielectric strenght (cond/cond/ shield)	1,5 kVac/1 min.
Min. insulation resistance	5,0 Ω x km
Transfer impedance at 10 MHz	20 mΩ/m

Power conductors

Max. DC cond. resistance	26,0 Ω x km
Dielectric strenght (cond/cond)	2,5 kVac/10 min.
Min. Insulation resistance	5,0 Ω x km

Part no.	No. of cores x cross section n x mm ²	Outer-Ø ca.mm ± 10%	Copper weight kg/km	Cable weight approx. kg/km	AWG no. (*)
39180CVB020M03	2 x 0,34	8	30,9	74	22
39180CV403BM07	2 x 0,34+3 x 0,75	10,4	45	90	22/19

PROFIBUS DP CABLES

SPECIAL PROFIBUS 644 for cable tracks

ELETTROTEK KABEL® SPECIAL PROFIBUS 644

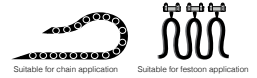

Construction:

Conductor:	flexible red copper conductor, extra fine wires
Insulation:	special PE compound, acc. to DIN VDE 0207 part 2
Colour cores:	(PA) red, green (Type B) acc to DIN 47100
Stranding:	in layers
Wrapping:	PETP foil
Screen:	tinned copper braid
Outer sheath:	violet (RAL 4001 or 4005), PUR type TMPU acc. to, DIN VDE 0282 part 10 (rough surface)

Resistance:



Oil resistance acc. to:
DIN VDE 0282 part 10 + HD 22.10

Technical data:

Peak operating voltage:	max. 350 V
Test voltage:	1,5 kV
Temperature range	
<i>Fixed laying:</i>	- 40°C up to +70°C
<i>Flexible installation:</i>	- 40°C up to +70°C
Min. bending radius:	
<i>Fixed laying:</i>	10 x d
<i>Flexible installation:</i>	15 x d
Max speed (main application):	250 m/min
Characteristic impedance 3-20 MHz:	PA: at 31.25 kHz 100 Ω ± 20% Typ B: at > 100 kHz 100 Ω - 130 Ω

Features:

for SPEED and MINIMUM BENDING RADIUS
see pages from 2 to 8 of catalogue

RoHS and CE approval



Part no.	No. of cores x cross section n x mm ²	Outer-Ø ca. mm ± 10%	Copper weight kg/km	Cable weight approx. kg/km	AWG no. *)
39190CVB020M02	2 x 0,25	5,2	15,9	33	24
39190CV4022M02	2 x 2 x 0,25	6,8	26,4	57	24

PROFIBUS DP CABLES

SPECIAL PROFINET-BUS UL/CSA, UL/CSA approval, for cable tracks



ELETTROTEK KABEL® SPECIAL PROFINET-BUS UL/CSA

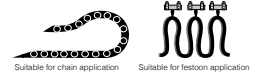

Construction:

Conductor:	flexible red copper conductor, extra fine wires
Insulation:	special PE compound,
Colour cores:	red, green
Stranding:	in pair + PE fillers
Wrapping:	non-woven tape
Screen:	aluminium tape + PETP foil and tinned copper braid
Outer sheath:	violet (RAL 4001 or 4005), PUR compound

Technical data:

Peak operating voltage:	max. 350 V
UL voltage	300 V
Temperature range	- 40°C up to +80°C
Min. bending radius:	
<i>Fixed laying:</i>	10 x d
<i>Flexible installation:</i>	15 x d
Max. installation pulling:	100 N
Max speed (main application):	250 m/min

Electrical and Transmission proprieties at 20°C

Max. DC loop cond. resistance	145 Ω/km
Max. DC conductor resistance	72,5 Ω/km
DC screen resistance	11 Ω/km
Max. attenuation at 9,6 kHz	0,3 dB/1000m
Max. attenuation at 38,4 kHz	0,5 dB/100m
Max. attenuation at 4 MHz	2,5 dB/100m
Max. attenuation at 16 MHz	4,9 dB/100m
Dielectric strenght (cond/cond/screen)	1,5 kV/1 min.
Min. insulation resistance	5,0 GΩ x km
Max. transfer impedance at 10 MHz	20 Ω/km
Capacitance at 800 Hz	1500 pF/km
Max. capacitance at 800 Hz	1500 pF/km
Impedance ≥ 1 MHz	150 Ω ± 10%

Resistance:



Fire performance acc. to:
IEC 60332-1



Halogen free acc. to:
IEC 60754-1 and EN 50267-2-1



Oil resistance acc. to:
IEC 60811-2-1 and ASTM oil 1



Mud resistant acc. to:
NEK 606



Ozone resistant acc. to:
acc. to VDE 0472 part. 1



Microbe resistant acc. to:
VDE 0282/10

Features:

AWM style 20233 80°C 300 V AWM I/II A/B FT 1

for SPEED and MINIMUM BENDING RADIUS
see pages from 2 to 8 of catalogue

RoHS and CE approval



Part no.	No. of cores x cross section n x mm ²	Outer-Ø ca. mm ± 10%	Copper weight kg/km	Cable weight approx. kg/km	AWG no. *)
39200CVB012A24	1x2x0,25	7,9	-	65	24

SPECIAL MODBUS 660



ELETTROTEK KABEL® SPECIAL MODBUS 660

Construction:

Conductor:	stranded red copper conductor
Insulation:	XLPE compound
Colour cores:	white/blue, white/orange, white/green, white/brown
Wrapping:	PETP foil
Screen	
<i>Individual:</i>	electrostatic screen of plastic and aluminium tape + tinned drain-wire
<i>Overall:</i>	electrostatic screen of plastic and aluminium tape + tinned drain-wire
Outer sheath:	black (RAL 9005), halogen free compound

Technical data:

Peak operating voltage:	max. 350 V
Test voltage:	1 kV
Temperature range	
<i>Fixed laying:</i>	- 5°C up to +50°C
<i>Flexible installation:</i>	- 30°C up to +90°C
Min. bending radius:	7,5 x d
Characteristic impedance 1 MHz:	105 Ω ± 10%

Resistance:



Self-extinguishing and flame retardant acc.to:
IEC 60332-1-2
IEC 60332-3-24



Oil resistance acc. to:
ICEA S-73-532



Halogen-free acc. to:
IEC60754-1



Low smoke emission acc to:
IEC 61034

Features:

RoHS and CE approval



Part no.	No. of cores x cross section n x mm ²	Outer-Ø ca. mm ± 10%	Copper weight kg/km	Cable weight approx. kg/km	AWG no. (*)
39238C7X022M07	2x2x0,75	14,1	-	171	19

CAN-BUS CABLES AND SAFETY BUS P CABLES

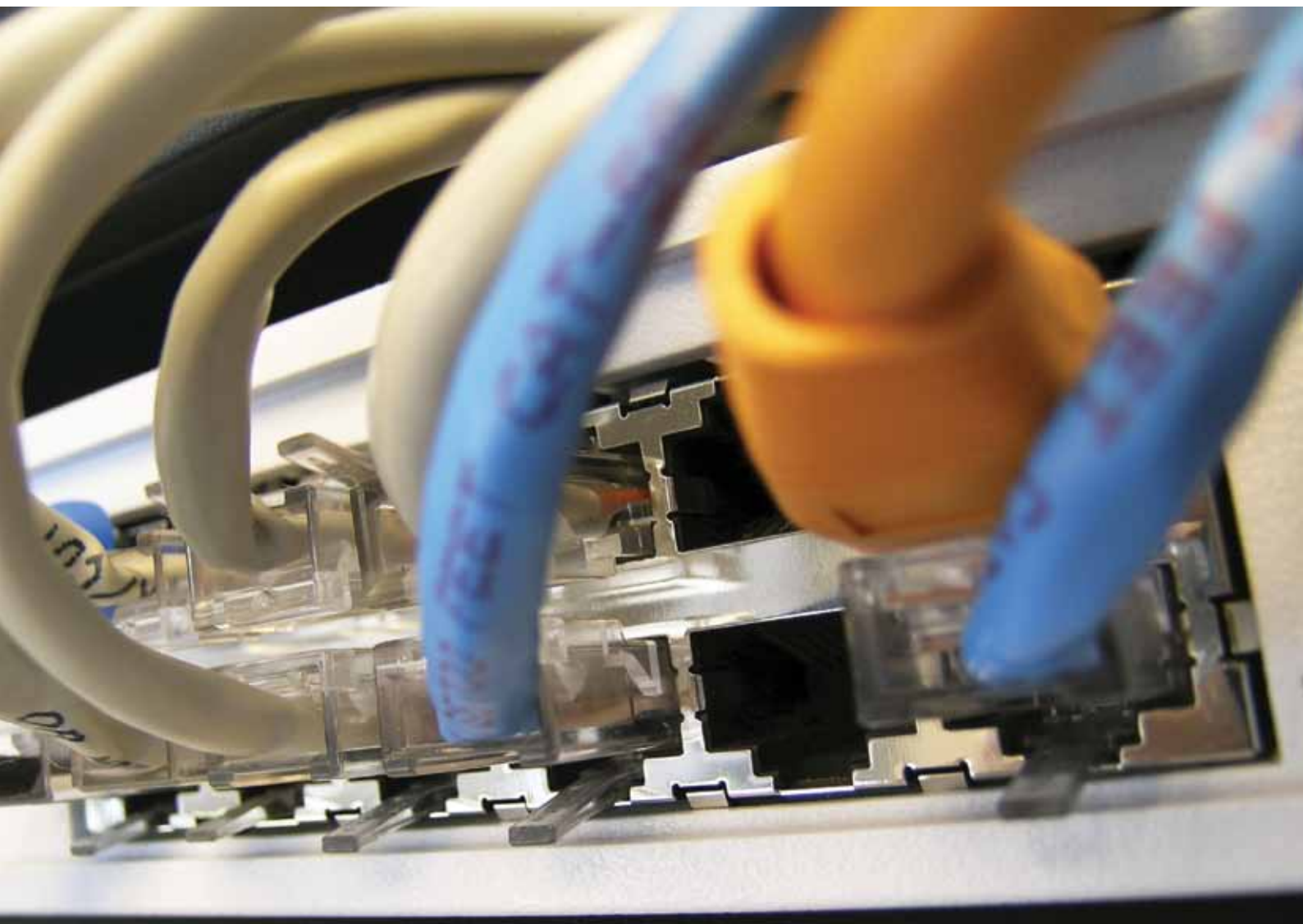

CAN-BUS CABLES

CAN-BUS 620 halogen-free,
CAN-BUS 620 FRNC halogen-free



ELETTROTEK KABEL® CAN-BUS 620

Construction:

Conductor:	stranded red copper conductor, acc. to DIN VDE 0812
Insulation:	halogen-free compound
Colour cores:	acc. to DIN 47100
Wrapping:	PETP foil
Screen:	tinned copper braid
Outer sheath:	violet (RAL 4001 or 4005) halogen-free compound

Resistance:



No flame propagation acc. to
IEC 60332-3C + EN 60332-3C
(CAN-BUS 620 FRNC)



Halogen free acc. to:
DIN VDE 0472 part 815
IEC60754-1



Corrosiveness of conflagration gases:
in compliance with IEC 60754-2
EN 50267-2-2 +
VDE 0482 part 267-2-2,
no development of corrosive conflagration gases



Smoke density acc. to:
IEC 61034 + EN 61034
(CAN-BUS 620 FRNC)



Oil resistance:
very good - TM5 acc. to DIN VDE 0281 part 1
(PB 630)

Technical data:

Peak operating voltage:	max. 350 V
Test voltage:	1,5 kV
Temperature range (CAN-BUS 620):	
<i>Fixed laying:</i>	- 50°C up to +90°C
<i>Flexible installation:</i>	- 40°C up to +90°C
Temperature range (CAN-BUS 620 FRNC):	
<i>Fixed laying:</i>	- 40°C up to +85°C
<i>Flexible installation:</i>	- 30°C up to +85°C
Min. bending radius:	7,5 x d
Bending characteristics:	acc. to DIN VDE 0472 part 603 test method H,min. 60000 single bendings characteristic
Characteristic impedance 3-20 MHz:	PA: at 31.25 kHz 100 Ω ± 20% Typ B: at > 100 kHz 100 Ω - 130 Ω
Radiation resistance:	(CAN-BUS 620): 5 x 10 ⁶ cJ/kg

Features:

RoHS and CE approval



Part no.	No. of cores x cross section n x mm ²	Outer-Ø ca. mm ± 10%	Copper weight kg/km	Cable weight approx. kg/km	AWG no. *)
39010CV4020M02	2 x 0,25	5,7	19	35	24
39020CV4020M02	2 x 0,25	5,7	19	41	24



CAN-BUS 627

UL approval

ELETTROTEK KABEL® CAN-BUS 627 UL

Construction:

Conductor:	stranded red copper conductor, 7x0,25 mm - 22/7 AWG
Insulation:	special PE compound, acc. to DIN VDE 0207 part 2
Colour cores:	acc. to DIN 47100
Wrapping:	PETP foil
Screen:	tinned copper braid
Outer sheath:	violet (RAL 4001 or 4005), PVC oil resistant compound, acc. to DIN VDE 0281 part 1

Resistance:



Self-extinguishing and flame retardant acc.to:
IEC 60332-1-2
EN 60332-1-2



Oil resistance:
very good acc. to DIN VDE 0207 part 5

Technical data:

Peak operating voltage:	max. 350 V
Voltage:	UL: 300 V
Test voltage:	1,5 kV
Temperature range	UL: up to +80°C
<i>Fixed laying:</i>	- 30°C up to + 70°C
<i>Flexible installation:</i>	- 5°C up to + 70°C
Min. bending radius:	7,5 x d
Characteristic impedance:	120 Ω (95 - 140 Ω)
Radiation resistance:	8 x 10 ⁶ cJ/kg

Features:

UL style: AWM style 2571 80°C 300V CE

RoHS and CE approval

good against acids, alkalines, solvents,hydraulic liquids etc.



Part no.	No.of cores x cross section n x mm ²	Outer-Ø ca.mm ± 10%	Copper weight kg/km	Cable weight approx. kg/km	AWG no.*)
39050CV4020A24	2 x 0,25	6	19	44	24
39050CV4020A22	2 x 0,34	6,4	21,8	47	22
39050CV4020A20	2 x 0,5	7,6	28,4	63	20
39050CV4020A19	2 x 0,75	9,6	39,6	93	19
39050CV4022A24	2x2x0,25	7,1	27,4	57	24
39050CV4022A22	2x2x0,34	7,7	33,5	66	22
39050CV4022A20	2x2x0,5	9,5	44,3	98	20
39050CV4022A19	2x2x0,75	13,5	80,8	174	19

CAN-BUS CABLES

S CAN-BUS 626 cable for cable tracks
S CAN-BUS 625 halogen-free, for cable tracks



ELETTROTEK KABEL® S CAN-BUS 626



Construction:

Conductor: flexible red copper conductor
extra fine wires

Insulation: **(S CAN BUS 626):**
GAALTEHRM® 545
(S CAN BUS 625)
special TPE compound

Colour cores: acc. to DIN 47100

Stranding: in layers

Wrapping: non-woven tape

Screen: tinned copper braid

Wrapping: non-woven tape

Outer sheath: violet (RAL 4001 or 4005), PUR type
TMPU, acc. to DIN VDE 0282 part 10,
(rough surface)

Resistance:



Halogen free acc. to:
DIN VDE 0472 part 815+IEC 60754-1
(S CAN BUS 625)



Corrosiveness of conflagration gases:
in compliance with IEC 60754-2
and EN 50267-2-2 + VDE 0482 part 267-2-2,
no development of corrosive conflagration gases
(S CAN BUS 625)



Oil resistance acc. to:
DIN VDE 0282 part 10 + HD 22.10

Technical data:

Peak operating voltage: max. 350 V

Test voltage: 1,5 kV

Temperature range

Fixed laying: - 50°C up to +90°C

Flexible installation: - 40°C up to +90°C

Min. bending radius: 7,5 x d

Bending characteristics: number of bendings
acc. to DIN VDE 0472 part 603
test methode H

S CB 626: single bendings min. 250.000

S CB 625: single bendings min. 500.000

Max speed (main application): 250 m/min

Characteristic impedance at 1 MHz: 120 Ω (95 - 140 Ω)

Radiation resistance: 5 x 10⁶ cJ/kg

Features:

for SPEED see pages from 2 to 4 of catalogue

RoHS and CE approval



Part no.	No. of cores x cross section n x mm ²	Outer-Ø ca. mm ± 10%	Copper weight kg/km	Cable weight approx. kg/km	AWG no. *)
39040CV4020M02	2 x 0,25	6,3	20,8	55	24
39030CV4020M02	2 x 0,25	8,1	25,3	75	24

SAFETY BUS P CABLES

S CAN-BUS 628

UL approval, halogen-free for cable tracks

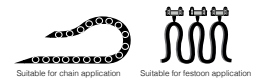

ELETTROTEK KABEL® S CAN-BUS 628

Construction:

Conductor:	flexible red copper conductor extra fine wires
Insulation:	special PE compound, acc. to DIN VDE 0207 part 2
Colour cores:	acc. to DIN 47100
Stranding:	in layers
Wrapping:	non-woven tapel
Inner sheath:	halogen-free compound
Screen:	tinned copper braid
Outer sheath:	violet (RAL 4001 or 4005), PUR type TMPU, acc. to DIN VDE 0281 part 10, (rough surface)

Technical data:

Peak operating voltage:	max. 350 V
Voltage:	UL: 300 V
Test voltage:	1,5 kV
Temperature range	UL: up to +80°C
<i>Fixed laying:</i>	- 50°C up to + 70°C
<i>Flexible installation:</i>	- 40°C up to + 70°C
Min. bending radius:	7,5 x d
Max speed (main application):	250 m/min
Characteristic impedance:	120 Ω (95 - 140 Ω)
Radiation resistance:	5 x 10 ⁶ cJ/kg

Part no.	No. of cores x cross section n x mm ²	Outer-Ø ca. mm ± 10%	Copper weight kg/km	Cable weight approx. kg/km	AWG no. (*)
39060CV4020A24	2x0,25	7,9	20,2	71	24
39060CV4020A22	2x0,34	8,3	22,9	77	22
39060CV4020A20	2x0,50	8,7	29,0	74	20
39060CV4022A24	2x2x0,25	9,1	27,9	90	24
39060CV4022A22	2x2x0,34	9,6	32,7	97	22
39060CV4022A20	2x2x0,5	10,6	44,9	94	20

Resistance:



Self-extinguishing and flame retardant acc. to:
IEC 60332-1-2
EN 60332-1-2



Halogen free acc. to:
DIN VDE 0472 part 815+IEC 60754-1



Corrosiveness of conflagration gases:
in compliance with IEC 60754-2
and EN 50267-2-2 + VDE 0482 part 267-2-2,



Oil resistance acc. to:
DIN VDE 0282 part 10 + HD 22.10

Features:

AWM style 20233 80°C 300 V

for SPEED see pages from 2 to 4 of catalogue

RoHS and CE approval



SAFETY BUS P CABLES

SAFE 680

fixed installation



Construction:

Conductor:	flexible red copper conductor Cl. 5, acc to IEC 60228, DIN VDE 0295
Insulation:	special PE compound, acc. to DIN VDE 0819 part 103
Colour cores:	acc. to DIN 47100
Wrapping:	non-woven tape
Screen:	tinned copper braid
Wrapping:	non-woven tape
Outer sheath:	yellow (RAL 1021), PUR compound

Resistance:



Oil resistance acc. to:
very good, TMPU, DIN VDE 0282 part 10,
DIN VDE 0473 part.811-2-1 IEC 60811-2-1

Technical data:

Peak operating voltage:	max. 350 V
Test voltage:	1,5 kV
Temperature range	- 40°C up to +80°C
Min. bending radius:	
<i>Fixed laying:</i>	5 x d
<i>Flexible installation:</i>	10 x d
Characteristic impedance at 1 MHz:	100 - 120 Ω

Features:

RoHS and CE approval



Part no.	No. of cores x cross section n x mm ²	Outer-Ø ca. mm ± 10%	Copper weight kg/km	Cable weight approx. kg/km	AWG no. *)
39410CY4030A19	3 x 0,75	7,8	43,2	74	19

SAFETY BUS P CABLES

ASI CABLES
EPDM, PUR, TPE



ELETTROTEK KABEL® ASI CABLES

Construction:

Conductor:	flexible tinned copper conductor Cl. 5, acc to IEC 60228, DIN VDE 0295
Insulation:	EPDM type: rubber compound PUR type: PUR type PO (UL) TPE type: TPE compound (UL)
Colour cores:	acc. to DIN VDE 0293-308, HD 308 S2
Stranding:	in layers
Outer sheath:	yellow (RAL 1021) or black (RAL 9005) EPDM type: rubber type EPDM PUR type: PUR compound (UL) TPE type: TPE compound (UL)

Features:

AWM style 20549, UL 758, UL 1581 FT2 CSA FT2 (PUR types)
RoHS and CE approval

AWM style 21439, UL 758, UL 1581 FT2 CSA FT2 (TPE types)
RoHS and CE approval (TPE)



Technical data:

Nominal voltage:	yellow: 32 V black: 48 V
Test voltage:	1 kV EPDM, PUR types (UL) 1,5 kV TPE type (UL)
Temperature range	EPDM TYPE: -40°C up to +85°C PUR TYPE: -40°C up to +85°C (UL) TPE TYPE: -40°C up to +105°C (UL)
Conductor resistance:	13,7 Ohm/km max.
Insulation resistance:	1 GOhm x km min.
Min. Bending Radius:	EPDM and PUR types: 30 mm TPE type: 24 mm

Part no.	No. of cores x cross section n x mm ²	Outer-Ø ca. mm ± 10%	Copper weight kg/km	Cable weight approx. kg/km	AWG no.*)
39420AYX020A16	2 x 1,5	-	31	70	16
39420A7X020A16	2 x 1,5	-	31	70	16
39421AYX020A16	2 x 1,5	-	31	64	16
39421A7X020A16	2 x 1,5	-	31	64	16
39422AYX020A16	2 x 1,5	-	31	70	16
39422A7X020A16	2 x 1,5	-	31	70	16

the 5th digit of part number refers to the different material.
0: EPDM
1: PUR
2: TPE

SAFETY BUS P CABLES

SAFETY 684 Move

for flexible application



Construction:

Conductor:	flexible red copper conductor Cl. 5, acc to IEC 60228, DIN VDE 0295
Insulation:	special PE compound, acc. to DIN VDE 0819 part 103
Colour cores:	acc. to DIN 47100
Wrapping:	non-woven tape
Screen:	tinned copper braid
Wrapping:	non-woven tape
Outer sheath:	yellow (RAL 1021), PUR compound

Resistance:



Halogen free acc. to:
DIN VDE 0472 part 815+IEC60754-1



Oil resistance acc. to:
DIN VDE 0473, part 811-2-1, IEC 60811-2-1

Technical data:

Peak operating voltage:	max. 350 V
Test voltage:	1,5 kV
Temperature range	- 40°C up to +80°C
Min. bending radius:	
<i>Fixed laying:</i>	5 x d
<i>Flexible installation:</i>	10 x d
<i>Continuously flexible:</i>	12 x d
Characteristic impedance at 1 MHz:	100 - 120 Ω

Features:

RoHS and CE approval



Part no.	No. of cores x cross section n x mm ²	Outer-Ø ca. mm ± 10%	Copper weight kg/km	Cable weight approx. kg/km	AWG no. (*)
39430CY4030A19	3 x 0,75	7,8	43,2	74	19

DEVICENET™ CABLES

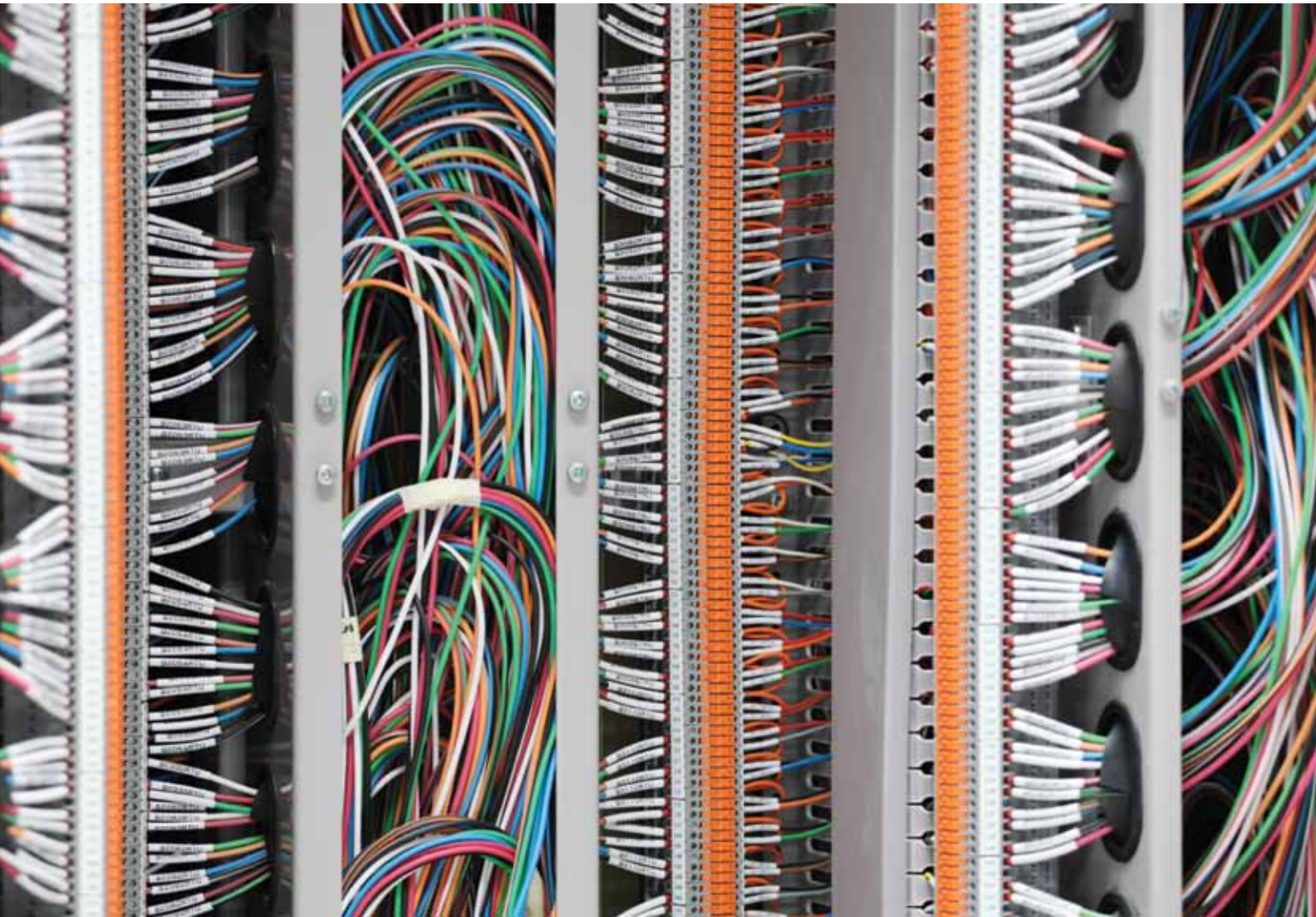



DEVICENET™ 650 UL approval
DEVICENET™ 651 UL approval

ELETTROTEK KABEL® DEVICENET 650



Construction:

Conductor:	flexible tinned copper conductor
Insulation:	1st pair: special PE compound, acc. to DIN VDE 0819 part 103 2nd pair: PVC type T12 acc. to DIN VDE 0281 part 1
Colour cores:	supply pair: black and red data pair: white and light blue
Stranding:	cores twisted in pairs, pairs twisted together
Screen:	pairs screened individually with aluminium tape tinned copper drain wire
Wrapping:	non-woven tape
Screen:	(DEVICENET 650): tinned copper braid (DEVICENET 651): aluminium tape
Outer sheath:	violet (RAL 4001 or 4005), PVC type TM1 acc. to DIN VDE 0281 part 1

Technical data:

Peak operating voltage:	max. 350 V
UL Voltage:	30 V
Test voltage:	1,5 kV
Temperature range	DIN/VDE UL
<i>Fixed laying:</i>	-30 up to +70°C up to +60 °C
<i>Flexible installation:</i>	-5 up to +70°C
Min. bending radius:	
<i>Fixed laying:</i>	7,5 x d
<i>Flexible installation:</i>	15 x d
Characteristic impedance at 1 MHz:	120 Ω ± 10%

Features:

AWM style 2560 60°C 30 V CE

RoHS and CE approval



Part no.	No. of cores x cross section n x mm ²	Outer-Ø ca. mm ± 10%	Copper weight kg/km	Cable weight approx. kg/km	AWG no. (*)
39350AVX02BA24	2 x 0,24 + 2 x 0,38	6,5	41,2	74	24/22
39350AVX02BA18	2 x 0,96 + 2 x 1,53	11,5	98,7	166	18/16
39360AVX02BA24	2 x 0,24 + 2 x 0,38	6,5	16,4	57	24/22
39360AVX02BA18	2 x 0,96 + 2 x 1,53	11,5	58,4	116	18/16

DEVICENET™ 656 halogen-free UL approval
 DEVICENET™ 657 halogen-free



ELETTROTEK KABEL® DEVICENET 656



Construction:

Conductor: flexible tinned copper conductor

Insulation: **1st pair:** special PE compound, acc. to DIN VDE 0819 part 103
2nd pair: PVC type T12 acc. to DIN VDE 0281 part 1

Colour cores: **supply pair:** black and red
data pair: white and light blue

Stranding: cores twisted in pairs, pairs twisted together

Screen: pairs screened individually with aluminium tape tinned copper drain wire

Wrapping: non-woven tape

Screen: **(DEVICENET 657):** tinned copper braid
(DEVICENET 656): aluminium tape

Outer sheath: violet (RAL 4001 or 4005), halogen free compound

Technical data:

Peak operating voltage: max. 350 V

UL Voltage: **(DEVICENET 656):** 300 V

Test voltage: 1,5 kV

Temperature range **(DEVICENET 656) UL:** up to + 75°C

Fixed laying: - 40 up to +70°C

Flexible installation: - 30 up to +70°C

Min. bending radius:

Fixed laying: 7,5 x d

Flexible installation: 15 x d

Characteristic impedance at 1 MHz: 120 Ω ± 10%

Features:

AWM style 21080 75°C 300 V **(DEVICENET 656)**

acc. to DIN VDE 0472 part 815+IEC60754-1

RoHS and CE approval



Part no.	No. of cores x cross section n x mm ²	Outer-Ø ca. mm ± 10%	Copper weight kg/km	Cable weight approx. kg/km	AWG no. (*)
39370CVX02BA24	2 x 0,24 + 2 x 0,38	6,5	16,4	56	24/22
39370CVX02BA18	2 x 0,96 + 2 x 1,53	11,5	58,4	120	18/16
39380CVX02BA24	2 x 0,24 + 2 x 0,38	6,5	41,2	74	24/22
39380CVX02BA18	2 x 0,96 + 2 x 1,53	11,5	98,7	183	18/16



DEVICENET™ 658 UL approval
DEVICENET™ 659 UL approval

ELETTROTEK KABEL® DEVICENET 658



Construction:

Conductor:	flexible tinned copper conductor
Insulation:	1st pair: special PE compound, acc. to DIN VDE 0819 part 103 2nd pair: PVC type T12 acc. to DIN VDE 0281 part 1
Colour cores:	supply pair: black and red data pair: white and light blue
Stranding:	cores twisted in pairs, pairs twisted together
Screen:	pairs screened individually with aluminium tape + tinned copper drain wire
Wrapping:	non-woven tape (optional)
Screen:	(DEVICENET 658): tinned copper braid (DEVICENET 659): aluminium tape
Outer sheath:	violet (RAL 4001 or 4005), PUR type TMPU, acc. to DIN VDE 0281 part. 10

Technical data:

Peak operating voltage:	max. 350 V
UL Voltage:	30 V
Test voltage:	1,5 kV
Temperature range	UL: up to + 60°C <i>Fixed laying:</i> - 30 up to +70°C <i>Flexible installation:</i> - 5 up to +70°C
Min. bending radius:	<i>Fixed laying:</i> 7,5 x d <i>Flexible installation:</i> 15 x d
Characteristic impedance at 1 MHz:	120 Ω ± 10%

Features:

AWM style 20417 60°C 30V

possible version with AWM style 21576 80°C 1000V identified with "H" on the 6th number of the Part. n

RoHS and CE approval



Part no.	No. of cores x cross section n x mm ²	Outer-Ø ca. mm ± 10%	Copper weight kg/km	Cable weight approx. kg/km	AWG no. *)
39390CVX02BA22	2 x 0,24 + 2 x 0,38	6,5	41,2	74	24/22
39390CVX02BA16	2 x 0,96 + 2 x 1,53	11,5	98,7	166	18/16
39400CVX02BA22	2 x 0,24 + 2 x 0,38	6,5	16,4	57	24/22
39400CVX02BA16	2 x 0,96 + 2 x 1,53	11,5	58,4	115	18/16

INDUSTRIAL ETHERNET CABLE CAT. 5

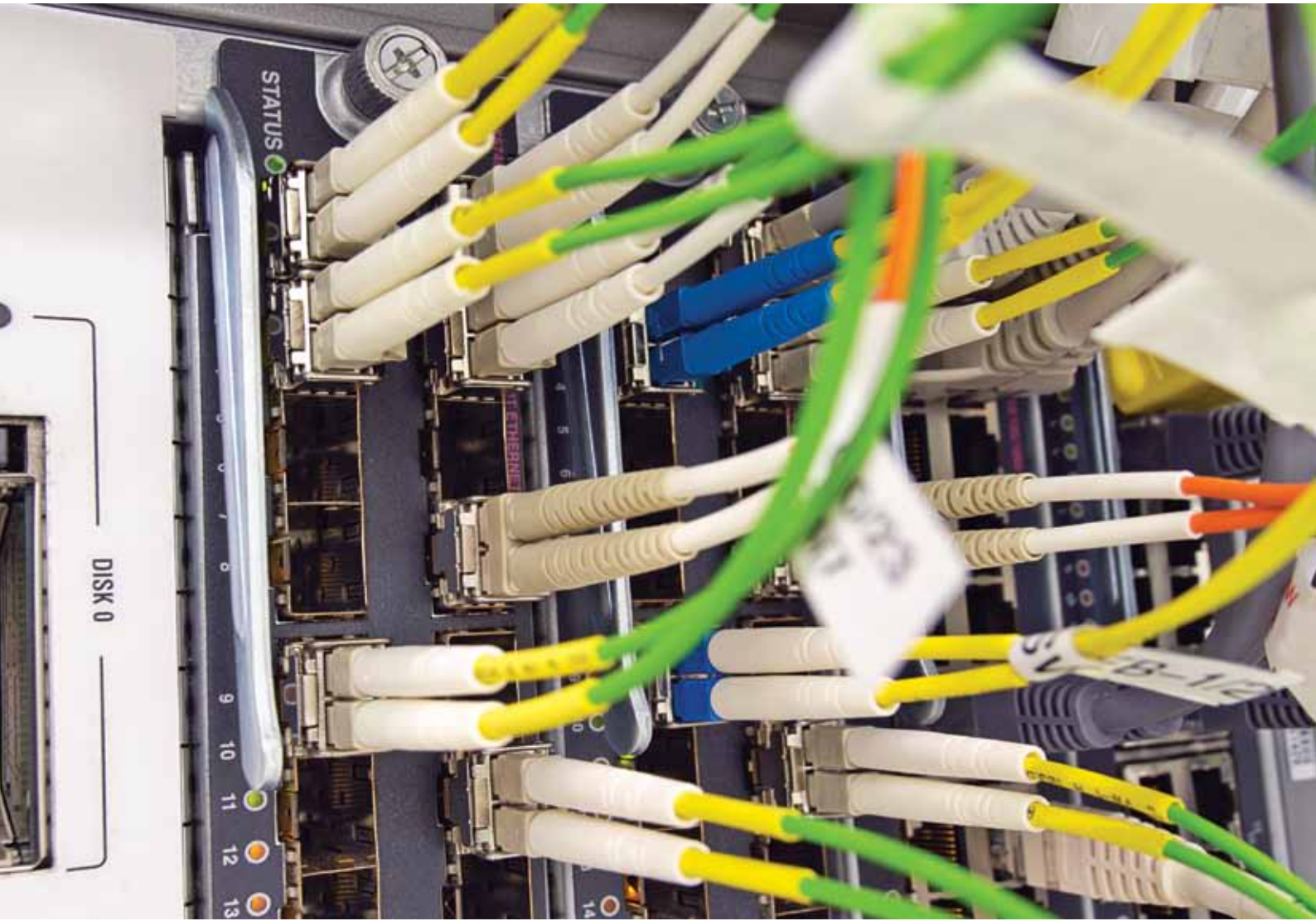

INDUSTRIAL ETHERNET CABLE



PROFINET 654 fixed installation, type A
PROFINET 655 fixed installation, type A, UL approval

ELETTROTEK KABEL® PROFIBUS 654



Construction:

Conductor:	solid red copper conductor
Insulation:	PE type LMD acc. to DIN VDE 0819 part 103
Colour cores:	blue, yellow, white, orange
Stranding:	in layers
Wrapping:	PETP foil
Screen:	tinned copper braid
Outer sheath:	green (similar RAL 6018) PVC compound

Resistance:



Oil resistance acc.to:
DIN VDE 0473 part.811-2-1 IEC 60811-2-1

Technical data:

Peak operating voltage:	max. 350 V
UL Voltage:	(PROFINET 655): 300 V
Test voltage:	core/core 1,5 kV core/screen 1,2 kV
Temperature range	(PROFINET 655) UL: up to +80°C
<i>Fixed laying:</i>	-30 up to +70°C
<i>Flexible application:</i>	-5 up to +70°C
Min. bending radius:	5 x d
Characteristic impedance:	100Ω ± 5Ω, acc. to EN 50288-2-2 (CAT 5 acc. to EN 50173-1)
Ohmic resistance at 20°C max.Ω/km:	58, acc. to VDE 0812

Features:

AWM style 10578-2571 80°C 300V (**PROFINET 655**)

RoHS and CE approval



Part no.	No. of cores x cross section n x mm ²	Outer-Ø ca. mm ± 10%	Copper weight kg/km	Cable weight approx. kg/km	AWG no. *)
39210CEX022M03	2 x 2 x 0,34	5,3	28	43	22
39220CEX022A22	2 x 2 x 0,34	5,9	30,4	51	22

INDUSTRIAL ETHERNET CABLE

PROFINET 660 flexible application, type B
PROFINET 661 flexible application, type B UL approval



ELETTROTEK KABEL® PROFIBUS 660

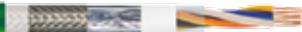

Construction:

Conductor: flexible red copper conductor, fine wires acc. to DIN VDE 0812
Insulation: PE type LMD acc. to DIN VDE 0819 part 103
Colour cores: blue, yellow, white, orange
Stranding: in layers
Wrapping: PETP foil
Inner sheath: thermoplastic compound
Screen: aluminium tape and tinned copper braid
Wrapping: non-woven tape
Outer sheath: green (similar RAL 6018) PVC compound

Resistance:



Halogen-free acc.to: DIN VDE 0472, part 815, IEC 60754-1

Technical data:

Peak operating voltage: max. 350 V
UL Voltage: **(PROFINET 661):** 300 V
Test voltage: core/core 1,5 kV
 core/screen 1,2 kV
Temperature range (PROFINET 661) UL: up to +75°C
Fixed laying: -40 up to +70°C
Flexible application: -30 up to +70°C
Temperature range (PROFINET 660):
Fixed laying: -30 up to +70°C
Flexible application: -20 up to +70°C
Min. bending radius:
Fixed laying: 5 x d
Flexible installation: 12 x d
Characteristic impedance: 100Ω ± 5Ω, acc. to EN 50288-2-2 (CAT 5 acc. to EN 50173-1)
Ohmic resistance at 20°C max.Ω/km: 58, acc. to VDE 0812

Features:

R



Part no.	No. of cores x cross section n x mm ²	Outer-Ø ca. mm ± 10%	Copper weight kg/km	Cable weight approx. kg/km	AWG no. *)
39230CEX022M03	2 x 2 x 0,34	6,6	36,2	67	22
39240CEX022A22	2 x 2 x 0,34	6,6	36,2	70	22

INDUSTRIAL ETHERNET CABLE



PROFINET 662 flexible application, type B
PROFINET 663 flexible application, type B, UL approval,
PROFINET 663 PLTC flexible application, type B, UL & PLTC approval



PROFINET 663



PROFINET 663 PLTC

Construction:

Conductor: **PROFINET 662):** flexible tinned copper conductor, fine wires acc. to VDE 0812
(PROFINET 663): flexible red copper conductor, fine wires acc. to VDE 0812
(PROFINET 663 PLTC): flexible tinned copper conductor, fine wires acc. to VDE 0812

Insulation: PE type L/MD acc. to DIN VDE 0819 part 103

Colour cores: blue, yellow, white, orange

Stranding: **(PROFINET 662 and 663 PLTC):** cores twisted in pairs, pairs twisted together
(PROFINET 663): in layers (star-quad construction)

Wrapping: PETP foil

Inner sheath: PVC compound

Screen: aluminium tape and tinned copper braid

Outer sheath: green (similar RAL 6018), PVC compound

Resistance:

Self-extinguishing and flame retardant acc.to:

(PROFINET 662)

IEC 60332-1-2

EN 60332-1-2

(PROFINET 663)

EC 60332-1-2

EN 60332-1-2,

UL 1581 section 1061 CSA FT1

(PROFINET 663 PLTC)

IEC 60332-3A,

UL 1685 CSA FT4

Oil resistance acc.to:

(PROFINET 662 and 663 PLTC)

DIN VDE 0473 part.811-2-1

IEC 60811-2-1

(PROFINET 663)

DIN VDE 0473 part.811-2-1

IEC 60811-2-1

and ICEA S-82-552,

UV resistance acc.to

(PROFINET 663, PROFINET 663 PLTC):

UL1581 §1200 Std.

Technical data:

Nominal voltage: **(PROFINET 662 and 663):** 300 V
(PROFINET 663 PLTC): 600 V

Test voltage: **(PROFINET 662 and 663):** 1,5 kV
(PROFINET 663 PLTC): 2 kV

Temperature range **(PROFINET 662):** **(PROFINET 663):** **(PROFINET 663 PLTC):**
UL: up to +80°C **UL:** up to +80°C

Fixed laying: -30 up to +70°C -30 up to +80°C -40 up to +80°C

Flexible installation: -5 up to +70°C -5 up to +80°C -5 up to +80°C

Min. bending radius: **(PROFINET 662):** **(PROFINET 663):** **(PROFINET 663 PLTC):**
Fixed laying: 5 x d 5 x d 5 x d
Flexible installation: 10 x d 10 x d 10 x d

Characteristic impedance: 100Ω ± 5Ω, acc. to EN 50288-2-2 CAT 5 acc. to EN 50173-1)

Ohmic resistance at 20°C max.Ω/km: 58, acc. to VDE 0812

Features:

AWM style 10578-2571 80°C 300V **(PROFINET 663)**

AWM style 21694 80°C 600V **(PROFINET 663 PLTC)**

RoHS and CE approval



Part no.	No. of cores x cross section n x mm ²	Outer-Ø ca. mm ± 10%	Copper weight kg/km	Cable weight approx. kg/km	AWG no. *)
39250CEX022M03 (PROFINET 662)	2 x 2 x 0,34	6	33,9	58	22
39261CEX014A22 (PROFINET 663)	1 x 4 x 0,34	6,5	33	74	22
39260FEX022A22 (PROFINET 663 PLTC)	2 x 2 x 0,34	6,6	36,2	67	22

INDUSTRIAL ETHERNET CABLE

PROFINET 679 flexible application, type B



ELETTROTEK KABEL® PROFINET 679 UL



Construction:

Conductor:	flexible tinned copper conductor, fine wires, acc. to VDE 0812
Insulation:	PE type L/MD acc. to DIN VDE 0819 part 103
Colour cores:	white/blue, white/orange, white/green, white/brown
Stranding:	cores twisted in pairs
Screen:	aluminium tape + PETP foil and tinned copper braid
Wrapping:	non-woven tape
Outer sheath:	green (similar RAL 6018), PUR compound

Resistance:



Halogen-free acc.to:
DIN VDE 0472, part 815 + IEC 60754-1)



Oil resistance acc.to:
TMPU acc. to DIN VDE 0473, part 811-2-1 IEC 60811-2-1

Technical data:

Peak operating voltage:	max. 350 V
Test voltage:	core/core 1,5 kV core/screen 1,2 kV
Temperature range	
<i>Fixed laying:</i>	-40 up to +70°C
<i>Flexible installation:</i>	-40 up to +70°C
Min. bending radius:	
<i>Fixed laying:</i>	5 x d
<i>Flexible installation:</i>	10 x d
Characteristic impedance:	100Ω ± 5Ω, acc. to EN 50288-2-2 CAT 5 acc. to EN 50173-1)
Ohmic resistance at 20°C max.Ω/km:	148, acc. to VDE 0812

Features:

RoHS and CE approval



Part no.	No.of cores x cross section n x mm ²	Outer-Ø ca.mm ± 10%	Copper weight kg/km	Cable weight approx. kg/km	AWG no.*)
39310CEX042M01	4 x 2 x 0,14	7,3	35	58	26

INDUSTRIAL ETHERNET CABLE

SPECIAL PROFINET 679 UL



ELETTROTEK KABEL® PROFINET 679 UL



Construction:

Conductor:	stranded tinned copper conductor, 7x0,25 mm - 22 AWG
Insulation:	PE compound
Colour cores:	white/blue, white/orange, white/green, white/brown
Stranding:	cores twisted in pairs
Screen:	aluminium tape + PETP foil and tinned copper braid
Wrapping:	non-woven tape
Outer sheath:	green (similar RAL 6018), FRNC compound

Resistance:



Self-extinguishing and flame retardant acc.to:
IEC 60332-3-22

Technical data:

Test voltage:	core/screen 700 V
Temperature range	
<i>Fixed laying:</i>	-40 up to +75°C
<i>Flexible installation:</i>	-40 up to +75°C
Min. bending radius:	
<i>Fixed laying:</i>	3 x d
<i>Flexible installation:</i>	7,5 x d
Characteristic impedance:	100Ω ± 5Ω, acc. to EN 50288-2-2 CAT 5 acc. to EN 50173-1

Features:

RoHS and CE approval



Special Profinet 679 UL Approvals:

Germanischer Lloyd
Lloyds Register
Bureau Veritas
ABS
Det Noske Veritas

Part no.	No. of cores x cross section n x mm ²	Outer-Ø ca. mm ± 10%	Copper weight kg/km	Cable weight approx. kg/km	AWG no. *)
39318CEX022A22	2 x 2 x 0,34	6,5	-	64	22

INDUSTRIAL ETHERNET CABLE

PROFINET 678 fixed installation, type A
SPECIAL PROFINET 678 UL flexible application, type B, UL approval



ELETTROTEK KABEL® SPECIAL PROFINET 678 UL



Construction:

Conductor:	(PROFINET 678): solid tinned copper conductor (PROFINET 678 UL): stranded tinned copper conductor, 7x0,16 mm - 26/7 AWG
Insulation:	PE compound
Colour cores:	white/blue, white/orange, white/green, white/brown
Stranding:	cores twisted in pairs, pairs twisted together
Wrapping:	PETP foil
Screen:	aluminium tape and tinned copper braid
Outer sheath:	green (similar RAL 6018), PVC compound

Technical data:

Peak operating voltage:	max. 350 V (PROFINET 678)
Nominal voltage:	125 V (PROFINET 678 UL)
Test voltage:	(PROFINET 678) core/core 1,5 kV core/screen 1,2 kV
Test voltage:	(PROFINET 678 UL) core/core 700 V core/screen 700 V
Temperature range	(PROFINET 678):
<i>Fixed laying:</i>	-30 up to +70°C
<i>Flexible installation:</i>	-5 up to +70°C
Temperature range	(PROFINET 678 UL):
<i>Fixed laying:</i>	-30 up to +80°C
<i>Flexible application:</i>	-5 up to +50°C
Min. bending radius:	
<i>Fixed laying:</i>	5 x d
<i>Sporadic movement:</i>	10 x d (PROFINET 678 UL)
Ohmic resistance at 20°C max.Ω/km:	150, acc. to VDE 0812 (PROFINET 678)
Max. DC conductor resistance:	140Ω km
Capacitance at 800 Hz:	48 pF/m
Max. capacitance unbalance:	1600 pF/km
Propagation velocity at 100 MHz:	approx. 75%
Characteristic impedance:	100Ω (± 15%)
Dielectric strength:	0,7 kVac x 1 min.
Min. Insulation resistance:	5,0 GΩ x km
Transfer impedance:	10 mΩ/m at 1 MHz, 4 mΩ/m at 10 MHz 4 mΩ/m at 30 MHz, 2 mΩ/m at 100 MHz
Standard reference:	IEC 61156-3, EN 50288-1, EN 50288-2-2 ISO IEC 11801

Resistance:



Flame retardant acc.to:
UL 1581 1061, CSA FT1, IEC 60332-1
standard requirements



Oil resistance acc.to:
DIN VDE 0473 part. 811-2-1 IEC 60811-2-1
(PROFINET 678)
EN 50363-4-1, IEC 60811-2-1, DIN VDE 0472-803
UL 13 (60°C), acc. to ICEA S-82-552 and NEMA
WC55 **(PROFINET 678 UL)**



Sunlight resistant acc.to:
UL 1581 1200 standard requirement

Features:

(UL) AWM style 1598 - 2571 30 V 80°C **(PROFINET 678 UL)**

RoHS and CE approval



INDUSTRIAL ETHERNET CABLE

PROFINET 678 fixed installation, type A
SPECIAL PROFINET 678 UL flexible application, type B, UL approval



ELETTROTEK KABEL® SPECIAL PROFINET 678 UL



Frequency (MHz)	ATTENUATION (dB/100 m)		NEXT (dB)		PS NEXT (dB)		PS EL-FEXT (dB/100m)		PS ACR (dB/100 m)		RETURN LOSS (dB)	
	max. - STD	typical	min. - STD	typical	min.	min.	min - STD	typical	min.	typical	min. STD	typical
1	3,2	2,5	65,3	71,0	62,3	69,0	60,8	69,0	62,1	68,5	-	29,0
4	6,0	5,2	56,3	63,0	53,3	61,0	48,8	57,0	50,3	57,8	24,1	32,0
10	9,5	8,4	50,3	58,0	47,3	56,0	40,8	51,0	40,8	49,6	25,0	32,0
16	12,1	11	47,2	56,0	44,2	54,0	36,7	47,0	35,1	45,0		
20	13,6	12,5	45,8	54,0	42,8	52,0	34,8	45,0	32,2	41,5		
31,25	17,1	16,0	42,9	50,0	39,9	48,0	30,9	42,0	25,8	34,0	23,6	30,0
62,5	24,8	23,6	38,4	45,0	35,4	43,0	24,9	36,0	13,6	21,4	21,5	28,0
100	32,0	29,9	35,3	43,0	32,3	41,0	20,8	32,0	3,3	13,1	20,1	26,0
155,52		37,4		40,0		38,0	-	26,0	-	2,6	-	24,0
200		42,8		37,0		35,0	-	22,0	-	-	-	23,0

Part no.	No. of cores x cross section n x mm ²	Outer-Ø ca. mm ± 10%	Copper weight kg/km	Cable weight approx. kg/km	AWG no. *)
39290CEX042M01	4 x 2 x 0,14	6,2	33	49	26
39300BEX042A26	4x2x0,14	6,2	33,0	54	26

INDUSTRIAL ETHERNET CABLE

SPECIAL PROFINET 668 continuously flexible, type C
SPECIAL PROFINET 669 continuously flexible, type C, UL approval



ELETTROTEK KABEL® SPECIAL PROFIBUS 668

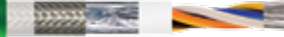

Construction:

Conductor:	flexible tinned copper conductors extra fine wires
Insulation:	special PE compound
Colour cores:	blue, yellow, white, orange
Stranding:	in layers
Wrapping:	PETP foil
Inner sheath:	thermoplastic compound
Screen:	aluminium tape and tinned copper braid
Wrapping:	non-woven tape
Outer sheath:	green (similar RAL 6018), PUR compound

Resistance:



Halogen-free acc.to:
DIN VDE 0472, part 815 + IEC 60754-1



Oil resistance acc.to:
DIN VDE 0282 part 10 + HD 22.10



UV resistance acc.to (PROFINET 668):
UL1581 §1200 Std.

Technical data:

Peak operating voltage:	max. 350 V	
UL Voltage:	(PROFINET 669): 300 V	
Test voltage:	core/core 1,5 kV core/screen 1,2 kV	
Temperature range (PROFINET 668)		
<i>Fixed laying:</i>	- 40 up to+70°C	
<i>Flexible application:</i>	- 30 up to+70°C	
Temperature range (PROFINET 669)	UL: up to+80°C	
<i>Fixed laying:</i>	- 30 up to+70°C	
<i>Flexible application:</i>	- 20 up to+70°C	
Min. bending radius:		
<i>Fixed laying:</i>	5 x d	
<i>Flexible installation:</i>	10 x d	
<i>Continuously flexible:</i>	15 x d	
Characteristic impedance:	100Ω ± 5Ω, acc. to EN 50288-2-2 (CAT 5 acc. to EN 50173-1)	

Features:

RoHS and CE approval



Part no.	No. of cores x cross section n x mm ²	Outer-Ø ca.mm ± 10%	Copper weight kg/km	Cable weight approx. kg/km	AWG no.)*
39270CEX022M03	2x2x0,34	6,4	36,7	58	22
39280CEX022A22	2x2x0,34	6,9	36,7	69	22

INDUSTRIAL ETHERNET CABLE

SPECIAL PROFINET 681 continuously flexible, type C
SPECIAL PROFINET 682 continuously flexible, type C, UL approval



ELETTROTEK KABEL® SPECIAL PROFINET 681



Construction:

Conductor:	flexible tinned copper conductors extra fine wires
Insulation:	halogen free compound
Colour cores:	white/blue, white/orange, white/green, white/brown
Stranding:	cores twisted in pairs
Wrapping:	non-woven tape
Screen:	aluminium tape and tinned copper braid
Wrapping:	non-woven tape
Outer sheath:	green (similar RAL 6018) PUR compound

Resistance:



Halogen-free acc.to:
DIN VDE 0472, part 815 + IEC 60754-1



Oil resistance acc.to:
DIN VDE 0282 part 10 + HD 22.10

Technical data:

Peak operating voltage:	max. 350 V
Test voltage:	core/core 1,5 kV core/screen 1,2 kV
Temperature range	
<i>Fixed laying:</i>	- 40 up to +90°C
<i>Flexible application:</i>	- 30 up to +90°C
Min. bending radius:	
<i>Fixed laying:</i>	5 x d
<i>Flexible installation:</i>	10 x d
<i>Continuously flexible:</i>	12 x d
Max speed (main application):	250 m/min
Characteristic impedance:	100Ω ± 5Ω, acc. to EN 50288-2-2 (CAT 5 acc. to EN 50173-1)

Features:

AWM 10493-20233 300V/80°C CE
(SPECIAL PROFINET 682)

for SPEED see pages from 2 to 4 of catalogue

RoHS and CE approval



Part no.	No. of cores x cross section n x mm ²	Outer-Ø ca. mm ± 10%	Copper weight kg/km	Cable weight approx. kg/km	AWG no. (*)
39320CEX042M01	4x2x0,14	7,2	35,5	58	26
39330CEX042A26	4x2x0,14	7,3	35,5	60	26

CABLE REELS



FLEXIDRUM® NSHTÖU



ELETTROTEK KABEL® FLEXIDRUM® NSHTÖU



Suitable for reel application



Suitable for festoon application

Construction:

Conductor:	flexible tinned copper conductor Cl. 5, acc to IEC 60228, DIN VDE 0295
Insulation:	rubber HEPR type 3GI3 acc. to DIN VDE 0207
Cores color:	acc. to DIN VDE 0293-308, HD 308 S2 from 6 cores black cores with consecutive numbers acc. to EN 50334; green-yellow earth-wire from 3 cores
Stranding:	in layers with short lay-length
Wrapping:	non-woven tape
Inner sheath:	rubber EPR type GM1B
Supporting screen:	anti-twisting protection of high-tech yarns
Outer sheath:	black (similar to RAL 9005), rubber pcp type, 5GM2

Resistance:



Self-extinguishing and flame retardant acc. to:
DIN VDE 0482 part 265-2-1
EN 50265-2-1
IEC 60332-1-2



Oil resistance acc. to:
DIN VDE 0473 part 811-2-1
IEC EN 60811-2-1

Technical data:

Nominal voltage:	Uo/U 0,6/1 kV Max. 1,2 kV
Test voltage:	3,5 kV
Max voltage permissible in A.C.:	0,9/1,8 kV
Temperature range:	
<i>Fixed laying:</i>	-45°C up to +80°C
<i>Flexible application:</i>	-35°C up to +80°C
Min. bending radius:	acc. to DIN VDE 0298 part 3
Conductor resistance:	as per VDE 0295 Class 5
Insulation resistance:	> 20 MOhm x km
Tensile strength:	20 N/mm ²
Max speed (main application):	180 m/min

Features:

UV and chemical resistant
acc. to standard DIN VDE 0250 part 814
on request yellow version
UL types on request
possible use in festoon systems up to 240 m/min
VDE approved
for SPEED and MINIMUM BENDING RADIUS
see pages from 2 to 8 of catalogue
RoHS and CE approval



CABLE REELS

FLEXIDRUM® NSHTÖU



ELETTROTEK KABEL® FLEXIDRUM® NSHTÖU



Suitable for reeling application



Suitable for festoon application

Part no.	No. of cores x cross section n x mm ²	Outer-Ø ca.mm ± 10%	Copper weight kg/km	Cable weight approx. kg/km	Tensile strength N	AWG no.)*
01010G7L010M61	1x10	10,5	96	200	200	8
01010G7L010M62	1x16	11,6	153	265	320	6
01010G7L010M63	1x25	13,3	240	370	500	4
01010G7L010M64	1x35	15	336	505	700	2
01010G7L010M65	1x50	17,2	480	650	1000	0
01010G7L010M66	1x70	18,6	672	875	1400	2/0
01010G7L010M67	1x95	21	912	1120	1900	3/0
01010G7L010M68	1x120	24	1152	1440	2400	4/0
01010G7L010M69	1x150	26	1440	1730	3000	250 MCM
01010G7L010M70	1x185	27,7	1776	2070	3700	350 MCM
01010G7L010M71	1x240	30,5	2304	2660	4800	450 MCM
01010G72031M15	3G1,5	13	43,2	255	68	16
01010G72031M25	3G2,5	14,5	72	310	113	14
01010G72031M40	3G4	16	115	395	240	12
01010G72031M60	3G6	18,2	172	525	360	10
01010G72031M61	3G10	21,3	288	765	600	8
01010G72031M62	3G16	24,6	460	1080	960	6
01010G72031M63	3G25	28	720	1470	1500	4
01010G72031M64	3G35	32	1008	2030	2100	2
01010G72031M65	3G50	37	1440	2680	3000	0
01010G72031M66	3G70	41	2016	3530	4200	2/0
01010G72031M67	3G95	45,5	2736	4400	5700	3/0
01010G72031M68	3G120	51,5	3456	5730	7200	4/0
01010G72031M69	3G150	57,5	4320	7040	9000	250 MCM
01010G72031M70	3G185	62	5328	8320	11100	350 MCM
01010G72031M71	3G240	70	6912	10850	14400	450 MCM
01010G72037M65	3x50 + 3G25/3	35,8	1680	2730	3000	0
01010G72037M66	3x70 + 3G35/3	41,2	2352	3740	4200	2/0
01010G72037M67	3x95 + 3G50/3	45,5	3216	4690	5700	3/0
01010G72037M68	3x120 + 3G70/3	51,7	4128	6220	7200	4/0
01010G72037M69	3x150 + 3G70/3	57,5	4992	7480	9020	250 MCM
01010G72037M70	3x185 + 3G95/3	62	6240	9020	11100	350 MCM
01010G72037M71	3x240 + 3G120/3	69,8	8064	11760	14400	450 MCM
01010G72037M72	3x300 + 3G150/3	72,5	9429	13946	21000	550 MCM
01010G72041M15	4G1,5	14,3	58	285	90	16
01010G72041M25	4G2,5	15,3	96	355	150	14
01010G72041M40	4G4	17	154	460	320	12
01010G72041M60	4G6	19,5	230	615	480	10
01010G72041M61	4G10	23	384	920	800	8
01010G72041M62	4G16	26,5	614	1310	1280	6
01010G72041M63	4G25	31,2	960	1860	2000	4
01010G72041M64	4G35	34,8	1344	2490	2800	2
01010G72041M65	4G50	40	1920	3300	4000	0
01010G72041M66	4G70	44	2688	4420	5600	2/0
01010G72041M67	4G95	50,8	3684	5610	7600	3/0
01010G72041M68	4G120	58	4608	7360	9600	4/0
01010G72041M69	4G150	63,2	5760	8770	12000	250 MCM
01010G72041M70	4G185	69,8	7100	10730	14800	350 MCM
01010G72041M71	4G240	76,2	9216	13560	19200	450 MCM
01010G72051M15	5G1,5	15	72	320	113	16
01010G72051M25	5G2,5	16,8	120	410	188	14
01010G72051M40	5G4	19	192	575	400	12
01010G72051M60	5G6	21	308	725	600	10
01010G72051M61	5G10	25,5	480	1140	1000	8
01010G72051M62	5G16	28,6	768	1550	1600	6
01010G72051M63	5G25	34,3	1200	2170	2500	4
01010G72051M64	5G35	38,5	1680	3080	3500	2
01010G72051M65	5G50	43,8	2400	4010	5000	0
01010G72051M66	5G70	50,2	3360	5480	7000	2/0
01010G72051M67	5G95	56,8	4560	7010	9500	3/0
01010G72048M61	4G10 + 4x2,5	24,3	480	1060	800	8
01010G72048M62	4G16 + 4x2,5	26,6	710	1360	1280	16
01010G72048M63	4G25 + 4x2,5	31,2	1056	1910	2000	16
01010G72048M64	4G35 + 4x2,5	34,5	1440	2530	2800	16
01010G72048M65	4G50 + 4x4	39,6	2073	3370	4000	0

CABLE REELS

FLEXIDRUM® NSHTÖÜ



ELETTROTEK KABEL® FLEXIDRUM® NSHTÖÜ



Suitable for reeling application



Suitable for festoon application

Part no.	No. of cores x cross section n x mm ²	Outer-Ø ca.mm ± 10%	Copper weight kg/km	Cable weight approx. kg/km	Tensile strength N	AWG no.®)
01010G70071M15	7G1,5	16,8	101	415	158	16
01010G70121M15	12G1,5	20,1	173	585	270	16
01010G70181M15	18G1,5	22,7	259	765	405	16
01010G70241M15	24G1,5	26,7	346	1040	540	16
01010G70301M15	30G1,5	27,7	432	1140	675	16
01010G70361M15	36G1,5	30,2	518	1370	810	16
01010G70421M15	42G1,5	31,8	564	1565	945	16
01010G70071M25	7G2,5	19,1	168	570	263	14
01010G70121M25	12G2,5	22,2	288	760	450	14
01010G70181M25	18G2,5	25,7	432	1070	675	14
01010G70241M25	24G2,5	30,2	576	1450	900	14
01010G70301M25	30G2,5	31,5	720	1600	1125	14
01010G70361M25	36G2,5	33,4	864	1850	1350	14
01010G70071M40	7G4	21,5	268	1850	420	12
01010G70071M60	7G6	26,3	429	960	630	10
01010G70121M40	12G4	26	460	1851	720	12
01010G70181M40	18G4	29,4	691	1852	1080	12
01010G71032M10	3x(2x1)C	22	-	670	90	18
01010G71032M15	3x(2x1,5)C	22,5	166	740	135	16
01010G71032M25	3x(2x2,5)C	25,5	227	980	-	14
01010G71062M10	6x(2x1)C	28	-	1080	180	18
01010G71062M15	6x(2x1,5)C	29,3	319	1210	270	16
01010G71062M25	6x(2x2,5)C	32,1	480	1570	450	14
01010G72049900	4G16+2x(4x1,5)	32,4	729,6	1550	1280	14
01010G70199901	19G2,5 + 5x1(C)	32,2	556	1580	713	14
01010G70199902	19G2,5 + 5x1,5(C)	33,7	566	1630	713	14
01010G70259903	25G2,5 + 5x1(C)	34,2	700	1820	938	14
01010G70259904	25G2,5 + 5x1,5(C)	34,2	711	1850	938	14
01010G70269905	26G2,5 + 10x1 (C)	37,8	-	2150	975	14
01010G70169906	16G4+(45x1)(C)	46	1028	2808	2180	12
01010G72048908	4G25+4x(6x2,5)	51,8	1499	3390	-	14
01010G72049911	4G25+7x1,5	36,8	1060	2330	2000	4
01010G72049912	4G25+3x(4x2,5)+1x(5x2,5)	49,7	1360	3800	2000	4
01010G7203B913	3x150+2x70/2+1x(6x2,5)	62,9	4800	7138	-	250 MCM
01010G71079914	7x(5x2,5)+12FO	52,5	857	3699	-	14
01010G7303B915	3x16+2x(3x4)	28,4	691,2	1330	-	6
01010G72049916	4G25+17x2,5	49,7	1368	3450	2000	4
01010G70059919	5G35+1x(6FO E9/125)	Max. 48,3	1678	3764	-	2
01010G71209920	5x(4x2,5)+1x(12FO 62,5/125)	Max. 39	455	1840	-	12
01010G72049923	4G16+1x(4x1)C+6FO E9/125	32,4	664	1700	1280	6
01010G7203B924	3x95+2G50/2+24FO E9/125	Max. 52,8	2940	5140	-	3/0
01010G7203B925	3x120+2G70/2+12FO E9/125	Max. 59	3990	6680	-	4/0
01010G70049926	4G25+7x2,5+ 12FO E9/125	51	1260	3350	-	4

Other dimensions and colors available on request.

FLEXIDRUM® NSHTÖU (V)



ELETTROTEK KABEL® FLEXIDRUM® NSHTÖU (V)



Suitable for reel application



Suitable for festoon application

Construction:

Conductor:	flexible tinned copper conductor Cl. 6, up to 6 mm ² Flexible tinned copper conductor Cl. 5, from 10 mm ²
Insulation:	rubber HEPR type 3GI3
Cores color:	acc. to DIN VDE 0293-308, HD 308 S2 from 6 cores black cores with consecutive numbers acc. to EN 50334; green-yellow earth-wire from 3 cores
Central unit:	special Kevlar
Stranding:	in layers around central unit
inner sheath:	yellow (similar to RAL 1021), rubber PCP compound
Supporting screen:	anti-twisting protection of high-tech yarns
Outer sheath:	yellow (similar to RAL 1021), rubber PCP compound

Technical data:

Nominal voltage:	U ₀ /U 0,6/1 kV
Test voltage:	3,5 kV
Max voltage permissible in A.C.:	0,7/1,2 kV
Max voltage permissible in D.C.:	0,9/1,8 kV
Temperature range:	
<i>Fixed laying:</i>	-50°C up to +80°C
<i>Flexible application:</i>	-40°C up to +80°C
Max. temperature on conductor:	up to +90°C
Max. temperature on short circuit:	up to +200°C
Min. bending radius:	acc. to DIN VDE 0298 part 3
Current carrying capacity:	acc. to DIN VDE 0298-4
Tensile strength:	until 30 N/mm ²
Inner torsion strength:	± 50°/m
Max speed (main application):	240 m/min

Resistance:



Self-extinguishing and flame retardant acc. to:
DIN VDE 0482 part 265-2-1
EN 50265-2-1
IEC 60332-1-2



Oil resistance acc. to:
DIN VDE 0473 part 811-2-1
IEC EN 60811-2-1

Features:

outdoor use, moisture and UV resistant
water stability: proved in a long-period test
vertical use
for SPEED and MINIMUM BENDING RADIUS
see pages from 2 to 8 of catalogue
RoHS and CE approval



CABLE REELS

FLEXIDRUM® NSHTÖU (V)



ELETTROTEK KABEL® FLEXIDRUM® NSHTÖU (V)



Suitable for reeling application



Suitable for festoon application

Part no.	No. of cores x cross section n x mm ²	Outer-Ø ca.mm ± 10%	Copper weight kg/km	Cable weight approx. kg/km	Tensile strength N	AWG no.*)
01020GY2041M40	4G4	16	153,6	465	2000	12
01020GY2041M60	4G6	18,4	230,4	568	2000	10
01020GY2041M61	4G10	26,1	384,0	1155	2000	8
01020GY2041M62	4G16	29	614,4	1533	2000	6
01020GY2041M63	4G25	34,4	960	2172	2000	4
01020GY2041M64	4G35	37,4	1344	2790	2800	2
01020GY2041M65	4G50	43,4	1920	3715	4000	1
01020GY2041M66	4G70	47,8	2688	4820	5600	2/0
01020GY2041M67	4G95	55,2	3648	6315	7600	3/0
01020GY2051M40	5G4	18,4	192	438	2000	12
01020GY2051M60	5G6	20	288	698	2000	10
01020GY2051M61	5G10	24,4	480	1085	2000	8
01020GY2051M62	5G16	27,6	768	1512	2400	6
01020GY2051M63	5G25	35,8	1200	2200	3750	4
01020GY2037M64	3x35+3G16/3	30	1161,6	2169	3150	2
01020GY2037M65	3x50+3G25/3	35,9	1680	2853	4500	0
01020GY2037M66	3x70+3G35/3	41,2	2352	3915	6300	2/0
01020GY2037M67	3x95+3G50/3	45,8	3216	5025	8550	3/0
01020GY2037M68	3x120+3G70/3	53	4128	6640	10800	4/0
01020GY2037M69	3x150+3G70/3	55,9	4992	7699	13500	250 MCM
01020GY2037M70	3x185+3G95/3	60,9	6240	9318	16650	350 MCM
01020GY2037M71	3x240+3G120/3	69,4	8064	12215	21600	450 MCM
01020GY2041M15	4G1,5	13	57,6	248	2000	16
01020GY2051M15	5G1,5	13,8	72	275	2000	16
01020GY0071M15	7G1,5	18,3	100,8	498	2000	16
01020GY0121M15	12G1,5	24,6	172,8	895	2000	16
01020GY0181M15	18G1,5	25,2	259,2	950	2000	16
01020GY0241M15	24G1,5	29,8	276,5	1056	2000	16
01020GY0301M15	30G1,5	32,4	432	1350	2000	16
01020GY0361M15	36G1,5	33,8	518,4	1400	2000	16
01020GY0441M15	44G1,5	35	633,6	1720	2000	16
01020GY0561M15	56G1,5	36,9	806,4	2215	2520	16
01020GY2031M25	3G2,5	13,8	72	310	2000	14
01020GY2041M25	4G2,5	14,3	96	370	2000	14
01020GY2051M25	5G2,5	15,2	120	439	2000	14
01020GY0071M25	7G2,5	20,9	168	630	2000	14
01020GY0121M25	12G2,5	24,7	288	1132	2000	14
01020GY0181M25	18G2,5	28,8	432	1234	2000	14
01020GY0241M25	24G2,5	31,7	576	1530	2000	14
01020GY0301M25	30G2,5	33,8	720	1810	2000	14
01020GY0361M25	36G2,5	35,9	864	1940	2000	14
01020GY0441M25	44G2,5	40,5	1056	2510	3300	14
01020GY0561M25	56G2,5	44,5	1344	3215	4200	14
01020GY0071M40	7G4	34	268,8	1080	2000	12
01020GY0121M40	12G4	34,4	460,8	1260	2000	12
01020GY0121M40	18G4	27	565,1	1770	2000	12
01020GY1032M10	3x(2x1)C	23	-	330	2000	18
01020GY1062M05	6x(2x0,5)C	24,1	-	402	2000	20
01020GY1062M10	6x(2x1)C	29,9	-	585	2000	18
01020GY1129900	(12x1)C	24,9	-	718	2000	18
01020GY0129901	12G2,5+12x(1)C	27,7	-	1154	2000	14
01020GY0199902	19G2,5+5x(1)C	28,5	545	1561	2000	14
01020GY0259903	25G2,5+5x(1)C	30,9	710	2158	2100	14
01020GY0199904	19G2,5+5x(1,5)C	31,4	594	1595	2000	14
01020GY0248M25	24G2,5+4x(1)C	38,5	665	2060	4000	14

FOR SPREADER APPLICATION:

Part no.	No. of cores x cross section n x mm ²	Outer-Ø ca.mm ± 10%	Copper weight kg/km	Cable weight approx. kg/km	Tensile strength N	AWG no.*)
01021GY0461M10	46G1	26,5	441,6	970	4700	18
01021GY0491M10	49G1	28,5	470,4	1100	-	18
01021GY0241M25	24G2,5	28,1	576	1200	3800	14
01021GY0301M25	30G2,5	31,3	720	1260	-	14
01021GY0361M25	36G2,5	32	864	1500	5700	14
01021GY0441M25	44G2,5	35,9	1056	1890	6900	14
01021GY0561M25	56G2,5	39	1344	2300	8800	14
01021GY0241M40	24G4	40,2	658	2280	4000	12

CABLE REELS

FLEXIDRUM® R 501

ELETTROTEK KABEL® FLEXIDRUM® R 501



Construction:

Conductor:	flexible red copper conductor Cl. 5, acc to IEC 60228, DIN VDE 0295
Insulation:	Power: rubber EPR special compound Earth: XLPE special compound
Cores color:	acc. to DIN VDE 0293-308, HD 308 S2 3 conductors + 3 earth conductors: grey, brown, black and green/yellow divided in interstices
Inner sheath:	special PVC compound
Outer sheath:	yellow (similar to RAL 1021), PUR compound

Technical data:

Nominal voltage:	U ₀ /U 0,6/1 kV Max. 1,2 kV
Test voltage:	3,5 kV
Temperature range:	
<i>Fixed laying:</i>	-30°C up to +80°C
<i>Flexible installation:</i>	-20°C up to +80°C
Max. temperature on conductor:	+ 90°C
Max. temperature in short circuit:	+ 250 °C
Min. bending radius:	
<i>Fixed laying:</i>	6 x D
<i>For repeated winding action(flexible):</i>	10 x D
<i>Guided on deflection pulleys (flexible):</i>	10 x D
Max speed (main application):	60 m/min

Resistance:



Self-extinguishing and flame retardant acc. to:
DIN VDE 0482 part 265-2-1
EN 50265-2-1
IEC 60332-1-2



Oil resistance acc. to:
DIN VDE 0473 part 811-2-1
IEC EN 60811-2-1

Features:

tunneling machines!

weather resistance: very good

chemical resistance: very good

possible version with antitwisting protection
identified with "1" on the 5th number of the Part. no

for SPEED and MINIMUM BENDING RADIUS
see pages from 2 to 8 of catalogue

RoHS and CE approval



Applications:

power supply to mobile equipment with high
risk of mechanical damage in mining and tunneling.

FLEXIDRUM® R 501 cable is suitable
for application where it is deflected in one plane only.

Correction factors for ambient temperature other than 30°C

°C	20	25	30	40	45	50	55
K	1,1	1,05	0,95	0,89	0,84	0,77	0,71

Part no.	No. of cores x cross section n x mm ²	Outer-Ø ca.mm ± 10%	Copper weight kg/km	Cable weight approx. kg/km	Tensile strength N	AWG no.®)
01040GY2037M63	3x25+3G6	25,5	892,8	1260	1500	4
01040GY2037M64	3x35+3G6	27,5	1180,8	1550	2100	2
01040GY2037M65	3x50+3G10	31	1728	2220	3000	1
01040GY2037M66	3x70+3G16	35,8	2476,8	3110	4200	2/0
01040GY2037M67	3x95+3G16	40,3	3196,8	3770	5700	3/0
01040GY2037M68	3x120+3G25	45,3	4176	4980	7200	4/0
01040GY2037M69	3x150+3G25	50,3	5040	6010	9000	250 MCM
01040GY2037M70	3x185+3G35	54,5	6336	7300	11100	350 MCM
01040GY2037M71	3x240+3G50	61	8352	9450	14400	450 MCM
01040GY2037M72	3x300+3G50	70,5	10080	12315	21000	550 MCM
01040GY203B901	3x25+2G16/2+2x1,5	28,6	902	1660	-	4
01040GY203B902	3x35+2G16/2+2x1,5	29,8	1190	1950	-	2
01040GY203B903	3x50+2G25/2+2x1,5	33,5	1708	2430	-	1
01040GY203B904	3x70+2G35/2+2x1,5	36,1	2380	3510	-	2/0
01040GY203B905	3x95+2G50/2+2x1,5	41,2	3245	4230	-	3/0
01040GY203B906	3x120+2G70/2+2x1,5	46,4	4157	5465	-	4/0
01040GY203B900	3x150+2G70/2+2x1,5	50,7	5020	6420	-	250 MCM
01040GY203B907	3x185+2G95/2+2x1,5	55,9	6268	7600	-	350 MCM
01040GY203B908	3x240+2G150/2+2x1,5	63,5	8380	10040	-	450 MCM
01040GY203B909	3x35+2G16/2+4x1	30,5	1200	2000	-	2
01040GY203B910	3x35+2G16/2+4x1,5	30,5	1220	2050	-	2
01040GY2039911	3x50+3G10+2x1,5	35,4	1708	2610	-	1

Other dimensions and colors available on request.

CABLE REELS

FLEXIDRUM® R 502

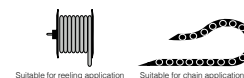

Construction:

Conductor:	flexible tinned copper conductor Cl. 5, acc to IEC 60228, DIN VDE 0295
Insulation:	GAALTHERM®530
Cores color:	acc. to DIN VDE 0293-308, HD 308 S2 from 6 cores black cores with consecutive numbers acc. to EN 50334; green-yellow earth-wire from 3 cores
Central unit:	textile element
Stranding:	in layers around central unit
Wrapping:	non-woven tape over each layer
Inner sheath:	PUR compound
Supporting screen:	anti-twisting protection of textile braid
Outer sheath:	yellow (similar to RAL 1021) or black (similar to RAL 9005) , PUR compound

Technical data:

Nominal voltage:	U ₀ /U 0,6/1 kV
Test voltage:	4 kV
Temperature range:	
<i>Fixed laying:</i>	-50°C up to +90°C
<i>Flexible installation:</i>	-40°C up to +90°C
Max. temperature on conductor:	+ 90°C
Max. temperature in short circuit:	+ 250 °C
Min. bending radius:	acc. to DIN VDE 0298 part 3
Max. torsion:	± 25°/1mt.
Max speed (main application):	with anti-twisting: 180 m/min without anti-twisting: 30 m/min

Resistance:



Self-extinguishing and flame retardant acc. to:
DIN VDE 0482 part 265-2-1
EN 50265-2-1
IEC 60332-1-2



Halogen-free acc. to:
DIN VDE 0482 part 267,
EN 50267-2-1,
IEC 60754-1



Oil resistance acc. to:
DIN VDE 0473 part 811-2-1
IEC EN 60811-2-1

Features:

UV resistance: very good
chemical resistance: good
small outer diameter
reduced cable weight
high winding and unwinding strength
possible version without anti-twisting protection identified with "1" on the 5th number of the Part. n
Possible black outer sheath version
for SPEED and MINIMUM BENDING RADIUS see pages from 2 to 8 of catalogue
RoHS and CE approval



Applications:

FLEXIDRUM® R 502 is used on heavy appliances like motor cable reel hoists, transport systems, movable motors and farm vehicles with high mechanical stress

Part no.	No. of cores x cross section n x mm ²	Outer-Ø ca.mm ± 10%	Copper weight kg/km	Cable weight approx. kg/km	Tensile strength N	AWG no.®)
01050GY2041M15	4G1,5	10,2	57,6	160	1875	16
01050GY2051M15	5G1,5	11,1	72	200	2225	16
01050GY0071M15	7G1,5	12,9	100,8	250	2090	16
01050GY0121M15	12G1,5	16,6	172,8	450	2540	16
01050GY0181M15	18G1,5	16,8	259,2	500	2540	16
01050GY0241M15	24G1,5	19,5	345,6	700	2740	16
01050GY0301M15	30G1,5	22,5	432	850	2840	16
01050GY0361M15	36G1,5	25	518,4	880	2840	16
01050GY0421M15	42G1,5	27,2	604,8	1050	2840	16

CABLE REELS

FLEXIDRUM® R 502



Part no.	No. of cores x cross section n x mm ²	Outer-Ø ca.mm ± 10%	Copper weight kg/km	Cable weight approx. kg/km	Tensile strength N	AWG no.®)
01050GY2041M25	4G2,5	11,7	96	240	1620	14
01050GY2051M25	5G2,5	12,5	120	260	2375	14
01050GY0071M25	7G2,5	14,3	168	350	2825	14
01050GY0121M25	12G2,5	19,1	288	650	3175	14
01050GY0181M25	18G2,5	19,3	432	700	3725	14
01050GY0241M25	24G2,5	22,6	576	950	3525	14
01050GY0301M25	30G2,5	25,7	720	1250	4525	14
01050GY0361M25	36G2,5	25,3	864	1300	4825	14
01050GY2041M40	4G4	15,5	153,6	350	1760	12
01050GY2041M60	4G6	16,7	230,4	400	1790	10
01050GY2041M61	4G10	19,8	384	650	2200	8
01050GY2041M62	4G16	22,2	614,4	850	2700	6
01050GY2041M63	4G25	28	960	1350	3200	4
01050GY2041M64	4G35	30,5	1344	1800	4200	2
01050GY2041M65	4G50	35,5	1920	2500	6000	1
01050GY2041M66	4G70	41,2	2688	3500	8400	2/0
01050GY2041M67	4G95	46,2	3648	4600	8400	3/0
01050GY2041M68	4G120	51	4608	5750	14400	4/0
01050GY2041M69	4G150	55,5	5760	7400	18000	250 MCM
01050GY2051M40	5G4	16,6	192	410	2600	12
01050GY2051M60	5G6	18,1	288	520	2900	10
01050GY2051M61	5G10	21,6	480	800	2900	8
01050GY2051M62	5G16	25	768	1100	2900	6
01050GY2051M63	5G25	30,5	1200	1780	3750	4
01050GY2051M64	5G35	34,3	1680	2350	5250	2
01050GY3030M72	3x300	66,8	8640	10850	27000	550 MCM
01050GY2037M65	3x50+3G25/3	32,3	1680	2320	4500	1
01050GY2037M66	3x70+3G35/3	36,1	2352	3180	6300	2/0
01050GY2037M67	3x95+3G50/3	41	3216	4020	8550	3/0
01050GY2037M68	3x120+3G70/3	45,8	4128	5370	10800	4/0
01050GY2037M69	3x150+3G70/3	51	4992	6440	13500	250 MCM
01050GY2037M70	3x185+3G95/3	54,6	6240	7780	16650	350 MCM
01050GY2037M71	3x240+3G120/3	66,3	7830	10800	-	450 MCM
01050GY2039900	3x25+3G16/3+2x1,5	27,4	902	1470	-	4
01050GY2039901	3x35+3G16/3+2x1,5	29,4	1190	1820	-	2
01050GY2039902	3x50+3G25/3+2x1,5	35,4	1708	2610	-	1
01050GY2039903	3x70+3G35/3+2x2,5	38,7	2400,2	3450	-	2/0
01050GY2039904	3x95+3G50/3+2x2,5	43,1	3264,2	4290	-	3/0
01050GY2039905	3x120+3G70/3+2x2,5	47	4176	5480	-	4/0
01050GY2039906	3x150+3G70/3+2x2,5	53,9	5040	6790	-	250 MCM
01050GY2039907	3x185+3G95/3+2x2,5	56,7	6287	8030	-	350 MCM
01050GY2039908	3x240+3G120/3+2x2,5	65,1	8112	10660	-	450 MCM

SECTIONS WITHOUT ANTI-TWISTING PROTECTION

01051GY2039900	3x25+3G16/3+2x1,5	25,6	902	1390	-	4
01051GY2039901	3x35+3G16/3+2x1,5	28	1190	1740	-	2
01051GY2039902	3x50+3G25/3+2x1,5	32,4	1708	2430	-	1
01051GY2039903	3x70+3G35/3+2x2,5	36,2	2400,2	3280	-	2/0
01051GY2039904	3x95+3G50/3+2x2,5	40,7	3264,2	4080	-	3/0
01051GY2039905	3x120+3G70/3+2x2,5	45,5	4176	5310	-	4/0
01051GY2039906	3x150+3G70/3+2x2,5	50,7	5040	6410	-	250 MCM
01051GY2039907	3x185+3G95/3+2x2,5	54,8	6287	7830	-	350 MCM
01051GY2039908	3x240+3G120/3+2x2,5	61,6	8112	9930	-	450 MCM

Other dimensions and colors available on request.

FLEXIDRUM® R 503



ELETTROTEK KABEL® FLEXIDRUM® R 503
 cULus AWM style 10492/21223 80° 600, 1000 V
 AWM II A/B 80°C 1000 V FT1



Suitable for reel application



Suitable for hoist application

Construction:

- Conductor:** flexible red copper conductor Cl. 6, acc to IEC 60228, DIN VDE 0295
- Insulation:** GAALTHERM® 585
- Cores color:** *Construction in layer/s (eg 4G, 12G, 30G):* black cores with consecutive numbers acc. to EN 50334 + green-yellow
Construction 3+3 (eg 3x25+3G4): 3 black conductors numbered + 3 green-yellow conductors divided in 3 inestices
Construction in pairs (eg 6x(2x1)C): black cores with consecutive numbers acc. to EN 50334
- Central unit:** core element (if necessary)
- Stranding:** *Construction in layer/s (eg 4G, 12G, 30G):* in layers with special yarns between cores + plastic tape between layers
Construction 3+3 (eg 3x25+3G4): phase units laid up with earth-conductors in interstices, with special yarns between phases + fillers (if necessary)
Construction in pairs (eg 6x(2x1)C): cores twisted in pairs + plastic foil / tinned copper braid / plastic foil / GAALTHERM® 585 sheath, pairs in layers around central unit + filler (if necessary)
- Wrapping:** non-woven tape or plastic tape
- Inner sheath:** PUR compound
- Supporting screen:** anti-twisting protection of textile braid
- Outer sheath:** black (similar to RAL 9005), PUR compound

Resistance:



Self-extinguishing and flame retardant acc. to:
 DIN VDE 0482 part 265-2-1
 EN 50265-2-1
 IEC 60332-1-2
 UL-VW-1, CSA FT-1



Halogen-free acc. to:
 DIN VDE 0482 part 267,
 EN 50267-2-1,
 IEC 60754-1



Oil resistance acc. to:
 DIN VDE 0473 part 811-2-1
 IEC EN 60811-2-1

Features:

- UV resistance: very good
- chemical resistance: good
- small outer diameter
- reduced cable weight
- high winding and unwinding strength

cULus AWM style 10492/21223 80° 600, 1000 V
 AWM II A/B 80°C 1000 V FT1

for SPEED and MINIMUM BENDING RADIUS
 see pages from 2 to 8 of catalogue

RoHS and CE approval



Technical data:

- Nominal voltage:** U₀/U 0,6/1 kV
- Nominal voltage UL:** 1000 V
- Test voltage:** 4 kV
- Temperature range DIN VDE:**
Fixed laying: -50°C up to +90°C
Flexible installation: -40°C up to +90°C
- Temperature range UL:**
Fixed laying: up to +80°C
Flexible installation: up to +80°C
- Max. temperature on conductor:** + 90°C
- Max. temperature in short circuit:** + 250 °C
- Min. bending radius:**
Fixed laying: 5 x d
Flexible laying: 7,5 x d
- Tensile strenght:**
Static 50 N/mm²
Dynamic: 20 N/mm²
- Max. torsion:** ± 25°/1mt.
- Max speed (main application):** 180 m/min

Applications:

FLEXIDRUM® R 503 is used on heavy appliances like motor cable reel hoists, transport systems, movable motors and farm vehicles with high mechanical stress

CABLE REELS

FLEXIDRUM® R 503



ELETTROTEK KABEL® FLEXIDRUM® R 503
 UL US AWM style 10492/21223 80° 600, 1000 V
 AWM II A/B 80°C 1000 V FT1



Suitable for reeling application

Suitable for festoon application

Part no.	No. of cores x cross section n x mm ²	Outer-Ø ca.mm ± 10%	Copper weight kg/km	Cable weight approx. kg/km	Tensile strength N	AWG no.*)
01120G70041A16	4G1,5	9,4	57,6	135	2000	16
01120G70051A16	5G1,5	10,1	72	160	2000	16
01120G70071A16	7G1,5	11,1	101	210	2500	16
01120G70121A16	12G1,5	13,6	172,8	310	3000	16
01120G70181A16	18G1,5	15,7	259,2	420	3500	16
01120G70241A16	24G1,5	18,8	345	560	4000	16
01120G70041A14	4G2,5	11	96	195	2500	14
01120G70051A14	5G2,5	12	120	235	2500	14
01120G70071A14	7G2,5	13,8	168	305	3000	14
01120G70121A14	12G2,5	17	288	460	3500	14
01120G70181A14	18G2,5	20	432	695	4000	14
01120G70241A14	24G2,5	23,2	576	925	4500	14
01120G70301A14	30G2,5	23,7	720	1250	5000	14
01120G70361A14	36G2,5	27,8	864	1410	5700	14
01120G70041A12	4G4	12,5	153,6	275	2500	12
01120G70041A10	4G6	14,9	230,4	390	3000	10
01120G70041A08	4G10	18	384	570	4000	8
01120G70041A06	4G16	21,5	614,4	915	4500	6
01120G70041A04	4G25	25,5	960	1360	5500	4
01120G70041A02	4G35	29,2	1344	1865	7000	2
01120G70041A01	4G50	34,5	1920	2650	9000	1
01120G70051A12	5G4	14,3	192	365	-	12
01120G70051A08	5G10	19,6	480	730	4000	8
01120G70051A06	5G16	23,6	768	1110	5500	6
01120G70051A04	5G25	28,3	1200	1685	6000	4
01120G70037A04	3x25+3G4	23,2	835	1105	5000	4
01120G70037A02	3x35+3G6	26,5	1180	1525	6000	2
01120G70037A01	3x50+3G10	31	1728	2155	7000	1
01120G70037A2C	3x70+3G16	36,4	2477	3100	8000	2/0
01121G70062A18	6x(2x1)C	20,1	204	455	2500	18

Other dimensions and colors available on request.

CABLE REELS

FLEXIDRUM® R 700



ELETTROTEK KABEL® FLEXIDRUM® R 700

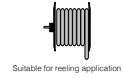

Construction:

Conductor:	flexible red copper conductor Cl. 6, acc to IEC 60228, DIN VDE 0295
Insulation:	GAALTHERM®585
Cores color:	acc. to DIN VDE 0293-308, HD 308 S2 from 6 cores black cores with consecutive numbers acc. to EN 50334; green-yellow earth-wire from 3 cores
Central unit:	textile element
Stranding:	in layers around central unit
Wrapping:	non-woven tape over each layer
Inner sheath:	special PUR compound
Supporting screen:	anti-twisting protection of high-tech yarns
Outer sheath:	yellow (similar to RAL 1021), special PUR compound

Resistance:



Self-extinguishing and flame retardant acc. to:
DIN VDE 0482 part 265-2-1
EN 50265-2-1
IEC 60332-1-2



Halogen-free acc. to:
DIN VDE 0482 part 267,
EN 50267-2-1,
IEC 60754-1



Oil resistance acc. to:
DIN VDE 0473 part 811-2-1
IEC EN 60811-2-1

Technical data:

Nominal voltage:	Uo/U 0,6/1 kV
Test voltage:	2,5 kV
Temperature range:	
<i>Fixed laying:</i>	-40°C up to +90°C
<i>Flexible installation:</i>	-30°C up to +90°C
Min. bending radius:	acc. to DIN VDE 0298 part 3
Insulation resistance:	> 20 MOhm x km
Tensile strength:	2000 N (up to 4000 N on request)
Max speed (main application):	250 m/min

Features:

for spreader application!

- vertical use
- small outer diameter
- reduced cable weight
- for SPEED and MINIMUM BENDING RADIUS see pages from 2 to 8 of catalogue
- RoHS and CE approval



Applications:

FLEXIDRUM® R 700 is used on heavy appliances like motor cable reel hoists, transport systems, movable motors and farm vehicles with high mechanical stress

FOR SPREADER APPLICATION:

Part no.	No. of cores x cross section n x mm ²	Outer-Ø ca.mm ± 10%	Copper weight kg/km	Cable weight approx. kg/km	Tensile strength N	AWG no.®)
01060GYA181M25	18G2,5	21,5	432	815	2000	14
01060GYA371M25	37G2,5	31	888	1550	4000	14
01060GYA441M25	44G2,5	34	1056	1800	4000	14
01060GYA561M25	56G2,5	-	1344	-	-	14

Other dimensions and colors available on request.

CABLE REELS

FLEXIDRUM® R 701 UL

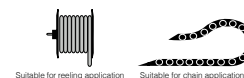

Construction:

Conductor:	flexible red copper conductor Cl. 6, acc to IEC 60228, DIN VDE 0295 (from 1,5 to 35 mm ²) Flexible red copper conductor Cl. 5, acc to IEC 60228, DIN VDE 0295 (from 50 mm ²)
Insulation:	GAALTHERM® 585
Cores color:	acc. to DIN VDE 0293-308, HD 308 S2 from 6 cores white cores with consecutive numbers acc. to EN 50334; green-yellow earth-wire from 3 cores
Central unit:	textile element
Stranding:	in layers around central unit
Wrapping:	non-woven tape over each layer
Inner sheath:	special PUR compound
Supporting screen:	anti-twisting protection of high-tech yarns
Outer sheath:	yellow (similar to RAL 1021) or black (similar to RAL 9005), special PUR compound

Resistance:



Self-extinguishing and flame retardant acc. to:
DIN VDE 0482 part 265-2-1
EN 50265-2-1
IEC 60332-1-2



Halogen-free acc. to:
DIN VDE 0482 part 267,
EN 50267-2-1,
IEC 60754-1



Oil resistance acc. to:
DIN VDE 0473 part 811-2-1
IEC EN 60811-2-1

Technical data:

Nominal voltage DIN VDE:	U ₀ /U 0,6/1 kV
Nominal voltage UL/CSA:	1000 V
Test voltage:	4 kV
Temperature range:	
<i>Fixed laying:</i>	-50°C up to +90°C
<i>Flexible installation:</i>	-40°C up to +90°C
Min. bending radius:	acc. to DIN VDE 0298 part 3
Insulation resistance:	> 20 MOhm x km
Tensile strength:	25 N per mm ² (standard type) 35 N per mm ² (reinforced type)
Max speed (main application):	250 m/min

Features:

vertical use
small outer diameter
reduced cable weight

AWM style 10264/20235 80° 1000 V
CSA AWM II A/B 90°C 600 V FT1

for SPEED and MINIMUM BENDING RADIUS
see pages from 2 to 8 of catalogue

RoHS and CE approval



CABLE REELS

FLEXIDRUM® R 70I UL



Suitable for reel application



Suitable for chain application

Part no.	No. of cores x cross section n x mm ²	Outer-Ø ca.mm ± 10%	Copper weight kg/km	Cable weight approx. kg/km	Tensile strength N	AWG no.)*
01070HY2041A16	4G1,5	10,5	57,6	165	150	16
01070HY2051A16	5G1,5	11	72	185	190	16
01070HYA071A16	7G1,5	13	100,8	255	265	16
01070HYA121A16	12G1,5	18,5	172,8	345	450	16
01070HYA181A16	18G1,5	18,8	259,2	540	675	16
01070HYA241A16	24G1,5	21,5	345,6	670	900	16
01070HYA301A16	30G1,5	24,8	432	910	1125	16
01070HYA361A16	36G1,5	25,7	518,4	945	1350	16
01070HYA421A16	42G1,5	26,7	604,8	1070	1575	16
01070HYA511A16	51G1,5	31,3	734,4	1530	1920	16
01070HY2041A14	4G2,5	12	96	220	250	14
01070HY2051A14	5G2,5	13	120	280	315	14
01070HYA071A14	7G2,5	15	168	340	440	14
01070HYA121A14	12G2,5	20,5	288	550	750	14
01070HYA181A14	18G2,5	21,3	432	740	1125	14
01070HYA241A14	24G2,5	25,1	576	995	1500	14
01070HYA301A14	30G2,5	27,9	720	1260	1875	14
01070HYA361A14	36G2,5	28,5	864	1335	2250	14
01070HYA421A14	42G2,5	31,5	1008	1525	2625	14
01070HYA501A14	50G2,5	34,9	1200	2150	3125	14
01070HYA511A14	51G2,5	35,5	1224	2200	3190	14
01070HY2041A12	4G4	12,8	153,6	280	400	12
01070HY2051A12	5G4	14,5	192	370	500	12
01070HY2041A10	4G6	17,2	230,4	420	600	10
01070HY2051A10	5G6	18	288	520	750	10
01070HY0071A10	7G6	21,2	403,2	730	1050	10
01070HY2041A08	4G10	19,9	384	645	1000	8
01070HY2051A08	5G10	21,2	480	780	1250	8
01070HYA071A08	7G10	26	672	1060	1750	8
01070HY2041A06	4G16	24	614,4	950	1600	6
01070HY2051A06	5G16	26	768	1180	2000	6
01070HY2041A04	4G25	28	960	1500	2500	4
01070HY2041A02	4G35	30,4	1344	2130	3500	2
01070HY2041A1C	4G50	35,5	1920	2620	5000	1
01070HY2041A2C	4G70	40,5	2688	3715	7000	2/0
01070HY2041A3C	4G95	50,9	3648	4810	9500	3/0
01070HY2041A4C	4G120	53,2	4608	5915	12000	4/0
01070HYA041A5C	4G150	56,3	5760	7120	15000	250 MCM
01070HY2037A1C	3G50+3x10	35	1728	2620	3750	1
01070HY2048A06	4G16+4x2,5	24	710,4	1060	2050	6
01070HY2169900	4G16+2x(4x1,5)C	29,5	925	1525	1600	6

REINFORCED TYPE:

Part no.	No. of cores x cross section n x mm ²	Outer-Ø ca.mm ± 10%	Copper weight kg/km	Cable weight approx. kg/km	Tensile strength N	AWG no.)*
01071HYA241A16	24G1,5	23,5	345,6	690	1260	16
01071HYA301A16	30G1,5	27,7	432	935	1575	16
01071HYA361A16	36G1,5	29,3	518,4	970	1890	16
01071HYA421A16	42G1,5	29,8	604,8	1200	2200	16
01071HYA491A16	49G1,5	32,9	705,6	1520	2580	16
01071HYA241A14	24G2,5	26,7	576	1015	2100	14
01071HYA301A14	30G2,5	29,1	720	1310	2625	14
01071HYA361A14	36G2,5	32,5	864	1425	3150	14
01071HYA421A14	42G2,5	33,8	1008	1650	3675	14
01071HYA491A14	49G2,5	38,3	1176	1700	4280	14

Other dimensions and colors available on request.

CABLE REELS

FLEXIDRUM® R 702



Construction:

Conductor:	flexible red copper conductor Cl. 5, acc to IEC 60228, DIN VDE 0295
Insulation:	GAALTHERM® 585
Cores color:	acc. to DIN VDE 0293-308, HD 308 S2 from 6 cores black cores with consecutive numbers acc. to EN 50334; green-yellow earth-wire from 3 cores
Central unit:	special yarns
Central unit insulation:	black (similar to RAL 9005), GAALTHERM® 585
Stranding:	in layers around central unit
Wrapping:	non-woven tape over each layer
Inner sheath:	PUR compound
Supporting screen:	anti-twisting protection of high-tech yarns
Outer sheath:	black (similar to RAL 9005) or yellow (similar to RAL 1021, PUR compound)

Resistance:



Self-extinguishing and flame retardant acc. to:
DIN VDE 0482 part 265-2-1
EN 50265-2-1
IEC 60332-1-2



Halogen-free acc. to:
DIN VDE 0482 part 267,
EN 50267-2-1,
IEC 60754-1



Oil resistance acc. to:
DIN VDE 0282 part 10
IEC EN 60811-2-1

Technical data:

Nominal voltage:	U _o /U 0,6/1 kV
Test voltage:	4 kV
Temperature range:	
<i>Fixed laying:</i>	-50°C up to +90°C
<i>Flexible installation:</i>	-40°C up to +90°C
Min. bending radius:	
<i>Fixed laying:</i>	≤12 mm 3 x d / >12 mm 4 x d
<i>For repeated winding action (flexible):</i>	6 x D
<i>Guided on deflection pulleys (flexible):</i>	7,5 x D
Max speed (main application):	120 m/min

Features:

New version! reduced weight and diameter

UV resistance: very good

chemical resistance: good

small outer diameter

reduced cable weight

for SPEED and MINIMUM BENDING RADIUS see pages from 2 to 8 of catalogue

RoHS and CE approval



Applications:

FLEXIDRUM® R 702 is used on heavy appliances, cable reels, for vertical use

CABLE REELS

FLEXIDRUM® R 702

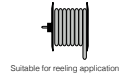

Part no.	No. of cores x cross section n x mm ²	Outer-Ø ca.mm ± 10%	Copper weight kg/km	Cable weight approx. kg/km	Tensile strength N	AWG no.**)
01080GY0491M10	49G1	25	470,4	880	3500	19
01080GY2041M15	4G1,5	9,1	57,6	111	1340	16
01080GY2051M15	5G1,5	9,9	72	133	1690	16
01080GY0071M15	7G1,5	11,9	100,8	193	2150	16
01080GY0121M15	12G1,5	16,7	172,8	341	2600	16
01080GY0181M15	18G1,5	16,5	259,2	411	2600	16
01080GY0251M15	25G1,5	21,3	360	620	-	16
01080GY0361M15	36G1,5	22,6	518,4	812	3500	16
01080GY2041M25	4G2,5	10,5	96	163	1345	14
01080GY2051M25	5G2,5	11,7	120	200	2100	14
01080GY0071M25	7G2,5	13,9	168	295	2500	14
01080GY0081M25	8G2,5	14,9	192	360	2800	14
01080GY0121M25	12G2,5	19,6	288	506	2900	14
01080GY0181M25	18G2,5	19,7	432	611	3450	14
01080GY0201M25	20G2,5	22	480	703	3000	14
01080GY0241M25	24G2,5	23,9	576	843	2700	14
01080GY0301M25	30G2,5	26,7	720	1057	4200	14
01080GY0361M25	36G2,5	26,8	864	1164	5000	14
01080GY0421M25	42G2,5	28,7	1008	1405	5750	14
01080GY0501M25	50G2,5	32,5	1200	1688	6750	14
01080GY0561M25	56G2,5	33,7	1344	1783	7900	14
01080GY2041M40	4G4	12,5	153,6	240	1690	12
01080GY0071M40	7G4	16,6	268,8	425	2600	12
01080GY0141M40	14G4	22,5	537,6	790	-	12
01080GY0161M40	16G4	23,9	614,4	880	3500	12
01080GY2041M60	4G6	14,6	230,4	344	1860	10
01080GY2041M61	4G10	18,1	384	574	2300	8
01080GY2041M62	4G16	22,4	614,4	873	2800	6
01080GY2048M62	4G16+4x2,5	23,6	670	1100	2050	6
01080GY2048M63	4x25+4G2,5	26,9	1056	1403	-	4
01080GY2037M63	3x25+3G6	24,3	892,8	1181	3300	4
01080GY2041M63	4G25	26,6	960	1341	3300	4
01080GY2037M64	3x35+3G6	28,1	1180,8	1569	3300	2
01080GY2041M64	4G35	31,2	1344	1880	3300	2
01080GY2037M65	3x50+3G10	31,9	1728	2219	3800	1
01080GY2041M65	4G50	35,4	1920	2592	4000	1

Other dimensions and colors available on request.

CABLE REELS

FLEXIDRUM® SPECIAL R 702



Construction:

Conductor:	flexible red copper conductor Cl. 5, acc to IEC 60228, DIN VDE 0295
Insulation:	GAALTHERM® 585
Cores color:	acc. to DIN VDE 0293-308, HD 308 S2 from 6 cores black cores with consecutive numbers acc. to EN 50334; green-yellow earth-wire from 3 cores or black cores with consecutive numbers acc. to EN 50334; green-yellow earth-wire from 3 cores also under 6 cores
Central unit:	special yarns
Central unit insulation:	black (similar to RAL 9005), GAALTHERM® 585
Stranding:	in layers around central unit
Wrapping:	non-woven tape over each layer
Inner sheath:	PUR compound
Supporting screen:	anti-twisting protection of high-tech yarns
Outer sheath:	black (similar to RAL 9005) or yellow (similar to RAL 1021), PUR compound

Resistance:



Self-extinguishing and flame retardant acc. to:
DIN VDE 0482 part 265-2-1
EN 50265-2-1
IEC 60332-1-2



Halogen-free acc. to:
DIN VDE 0482 part 267,
EN 50267-2-1,
IEC 60754-1



Oil resistance acc. to:
DIN VDE 0282 part 10
IEC EN 60811-2-1

Technical data:

Nominal voltage:	U _o /U 0,6/1 kV or U _o /U 300/500 V
Test voltage:	
U _o /U 0,6/1 kV:	4 kV
U _o /U 300/500 V:	2 kV
Temperature range:	
Fixed laying:	-50°C up to +90°C
Flexible installation:	-40°C up to +90°C
Min. bending radius:	
Fixed laying:	≤12 mm 3 x d / >12 mm 4 x d
For repeated winding action (flexible):	6 x D
Guided on deflection pulleys (flexible):	7,5 x D
Max speed (main application):	120 m/min

Features:

New version! reduced weight and diameter

UV resistance: very good
chemical resistance: good
small outer diameter
reduced cable weight
available:
supporting screen in fiber glass braid identified with "5" on the 5th number of the Part. no

for SPEED and MINIMUM BENDING RADIUS see pages from 2 to 8 of catalogue

RoHS and CE approval



Applications:

FLEXIDRUM® SPECIAL R 702 is used on heavy appliances, cable reels, for vertical use

CABLE REELS

FLEXIDRUM® SPECIAL R 702



Suitable for reeling application



Suitable for drum application

Part no.	No. of cores x cross section n x mm ²	Outer-Ø ca.mm ± 10%	Copper weight kg/km	Cable weight approx. kg/km	Tensile strenght N	AWG no.®)
01080GY2049900	4G16+4x2x1,5	28,2	729,6	1030	-	6/16
01080GY2049901	4G35+25x1,5	37,4	1704	2287	-	2/16
01080GY2049902	4G50+3x2x1	35,3	2069	2700	-	1/14
01080G72049903	4G50+7x2,5	39,2	2088	2786	5000	1
01080GY0449904	44G4	36,8	1689,6	2330	6200	12
01080GY0429905	42G4+3x1G62,5/125µm	37,9	1612,8	2251	5000	12/14/24
01080GY0189906	18G2,5+(4x2x0,14)PN	26,7	650	903	-	14/26
01080GY0309907	30G2,5+(8x2,5)C	31,5	980	1450	-	14/14
01080GY2049908	4G16+12x1,5+(4x1,5)C	36,5	868,5	1480	-	6/16/16
01080GY2049909	4G35+(3x2,5)ST+(2x1,5)ST(2x1)C	48	1486,5	3070	-	2/14/16/19
01080GY0169910	16G1,5+2x(1x1,5)C	19,1	280	530	-	16/16
01080GY3039911	3x35+1x16+(2x2,5)C	34,1	1231,1	1957	-	2/6/14
01080GY3039912	3x35+1x16+3x2,5	33,9	1233,6	1955	-	2/6/14
01080GY2059913	(4x2x0,14)S GE+9G4+5G6	34,8	674,2	1397	-	26/12/10
01080GY2059914	(2x2x0,34) PN+7G4+5G6	26,6	591,3	995	-	22/12/10
01080GY2049915	4G4+4x1,5+4x(1,5)C	21,6	310,3	609	-	12/16/16
01080GY3039916	3x35+2x10+12x1,5+(4x1,5)	41	1454,1	2323	-	2/8/16/16
01080GY3039917	3x50+(3G10)C	33	1924,4	2408	-	1/8
01080GY2049918	4G16+2x(4x1,5)C	25,6	840	1184	-	4/16
01080GY0089919	8G2,5+(4x2,5)C	21,9	310,8	632	-	14/14
01080GY0709920	70G4	45,4	2668	3586	-	12
01080GY1049921	4x2x0,14	10,7	40,6	120	-	26
01080GY2039922	3G2,5+40x0,5+20x1,5	-	-	-	-	14/18/16
01080G70359923	(35G2,5)C+18x2,5	35,3	1433	1868	-	14/14
01080G70049924	4G10+2x2,5+2x(2x0,75)C+3x3x0,75	32,4	557,4	1230	-	8/14/19/19
01080GY1049925	3x2x0,75	9,9	70,2	-	-	19
01080G72049926	4G25+17x2,5	-	1368	-	-	4/14
01080G72049927	4x1,5+2x(2x0,75)C+(4x0,14+4x0,34)C	18,9	149,1	418	-	16/19/26/24
01080G72049928	4G4+2x2,5+2x(2x0,34)	19,1	285	540	-	12/14/22
01080G70309929	30G4+(6x2,5)C	42	1350	2367	25000	4/14
01080D70049930	4G25+4x2x2,5	30	1152	1502	4000	4/14
01080G70242931	24g2,5+2x4g50/125	27,7	576	1017	-	14
01080G70259932	25G2,5+5x(1,5)C	27,2	682,4	1094	-	14/16
01080G70268M25	(4x2,5)C+26g2,5	25,6	791,4	1053,2	-	14/14
01080G72059933	5G35+7x1,5	38	1780,8	2504	-	2/16
01080G70249934	24G2,5+6x(2x1)C	33	787	1425	-	14/18
01085GY0181M40	18G4	24	691,2	-	-	12
01080G7025BM60	25G6+2x(2x1)C	40,1	1510,3	2335	2500	10/18
01080D70089935	8G10+(2x2x1)C+2x3x1,5+2x6	34,3	1024,1	1786	-	8/18/16/10
01080GY037BM25	37G2,5+(2x0,34)CB	30	913,4	1346	5000	14/24
01080G72059936	5G35+7x2,5	38,5	1848	2585	-	2/14

Other dimensions and colors available on request.

FLEXIDRUM® R 703



Construction:

Conductor:	flexible red copper conductor Cl. 5, acc to IEC 60228, DIN VDE 0295
Insulation:	GAALTHERM® 585
Cores color:	acc. to DIN VDE 0293-308, HD 308 S2 from 6 cores black cores with consecutive numbers acc. to EN 50334; green-yellow earth-wire from 3 cores
Central unit:	aramide yarns
Central unit insulation:	black (similar to RAL 9005), GAALTHERM® 540
Stranding:	in layers around central unit
Wrapping:	non-woven tape over each layer
Inner sheath:	black (similar to RAL 9005), PUR compound
Supporting screen:	anti-twisting protection of high-tech yarns
Outer sheath:	black (similar to RAL 9005) special PUR compound

Resistance:



Self-extinguishing and flame retardant acc. to:
DIN VDE 0482 part 265-2-1
EN 50265-2-1
IEC 60332-1-2



Halogen-free acc. to:
DIN VDE 0482 part 267,
EN 50267-2-1,
IEC 60754-1



Oil resistance acc. to:
DIN VDE 0282 part 10
IEC EN 60811-2-1

Technical data:

Nominal voltage:	U ₀ /U 0,6/1 kV
Test voltage:	3,5 kV
Temperature range:	
<i>Fixed laying:</i>	-50°C up to +120°C
<i>Flexible installation:</i>	-40°C up to +120°C
Min. bending radius:	
<i>Fixed laying:</i>	4 x d
<i>For repeated winding action (flexible):</i>	6 x D
<i>Guided on deflection pulleys (flexible):</i>	7,5 x D
Max speed (main application):	120 m/min

Features:

max. temperature up to +120°C!
UV resistance: very good
chemical resistance: good
small outer diameter
reduced cable weight
for SPEED and MINIMUM BENDING RADIUS see pages from 2 to 8 of catalogue
RoHS and CE approval



Applications:

FLEXIDRUM® SPECIAL R 703 is used on heavy appliances, cable reels, for vertical use up to +120°C

CABLE REELS

FLEXIDRUM® R 703

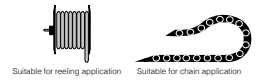

Part no	No. of cores x cross section n x mm ²	Outer-Ø ca.mm ± 10%	Copper weight kg/km	Cable weight approx. kg/km	Tensile strenght N	AWG no.*)
01100G70491M10	49G1	25	470,4	880	3500	19
01100G72041M15	4G1,5	9,1	57,6	111	1340	16
01100G72051M15	5G1,5	9,9	72	133	1690	16
01100G70071M15	7G1,5	11,9	100,8	193	2150	16
01100G70121M15	12G1,5	16,7	172,8	341	2600	16
01100G70181M15	18G1,5	16,5	259,2	411	2600	16
01100G72041M25	4G2,5	10,5	96	163	1345	14
01100G72051M25	5G2,5	11,7	120	200	2100	14
01100G70071M25	7G2,5	13,9	168	295	2500	14
01100G70081M25	8G2,5	14,9	192	360	2800	14
01100G70121M25	12G2,5	19,7	288	506	2900	14
01100G70181M25	18G2,5	19,6	432	611	3450	14
01100G70241M25	24G2,5	23,9	576	843	2700	14
01100G70301M25	30G2,5	26,7	720	1057	4200	14
01100G70361M25	36G2,5	26,8	864	1164	5000	14
01100G70421M25	42G2,5	28,7	1008	1405	5750	14
01100G70501M25	50G2,5	32,5	1200	1688	6750	14
01100G70561M25	56G2,5	33,7	1344	1783	7900	14
01100G72041M40	4G4	12,5	153,6	240	1690	12
01100G70071M40	7G4	16,6	268,8	425	2600	12
01100G70161M40	16G4	23,9	614,4	880	3500	12
01100G72041M60	4G6	14,6	230,4	344	1860	10
01100G72041M61	4G10	18,1	384	574	2300	8
01100G72041M62	4G16	22,4	614,4	873	2800	6
01100G72048M62	4G16+4x2,5	23,6	670	1100	2050	6
01100G72037M63	3x25+3G6	24,3	892,8	1181	3300	4
01100G72041M63	4G25	26,6	960	1341	3300	4
01100G72051M63	5G25	30,1	1200	1696	3500	4
01100G72037M64	3x35+3G6	28,1	1180,8	1569	3300	2
01100G72041M64	4G35	31,2	1344	1880	3300	2
01100G72037M65	3x50+3G10	31,9	1728	2219	3800	1
01100G72041M65	4G50	35,4	1920	2592	4000	1

Other dimensions and colors available on request.

FLEXIDRUM® MEDIUM R 902

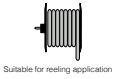

Construction:

Conductor:	flexible red copper conductor Cl. 5, acc to IEC 60228, DIN VDE 0295
Inner semi-conductive layer:	semi-conducting compound
Insulation:	rubber EPR special compound
Outer semi-conductive layer:	semi-conducting compound
Cores color:	Power: natural color with black semi-conducting compound Earth: black semi-conducting compound
Inner sheath:	PUR compound
Supporting screen:	anti-twisting protection of high-tech yarns
Outer sheath:	red (similar to RAL 3000) special PUR compound

Technical data:

Nominal voltage:	U/oU 3,6/6 kV up to 12/20 kV
Temperature range	
<i>Fixed laying:</i>	-40°C up to +80°C
<i>Flexible installation:</i>	-25°C up to +80°C
Max. temperature on conductor:	+ 90°C
Max. temperature in short circuit:	+ 250 °C
Min. bending radius:	acc. to DIN VDE 0298 part 3
Tensile strength:	25 N per mm ²
Max speed (main application):	120 m/min

Resistance:



Self-extinguishing and flame retardant acc. to:
DIN VDE 0482 part 265-2-1
EN 50265-2-1
IEC 60332-1-2

Features:

mining excavator!
outdoor use
UV, ozone, moisture resistant
oil resistance: very good
small outer diameter
reduced cable weight
Possible without anti-twisting reinforcement
for SPEED and MINIMUM BENDING RADIUS
see pages from 2 to 8 of catalogue

RoHS approval



CABLE REELS

FLEXIDRUM® MEDIUM R 902

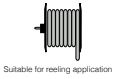

3,6/6 kV (7,2) kV

Part no.	No. of cores x cross section n x mm ²	Outer-Ø ca.mm ± 10%	Copper weight kg/km	Cable weight approx. kg/km	Tensile strenght N	AWG no.®)
02010MR1037M63	3x25+3x25/3	35	960	1900	2500	4
02010MR1037M64	3x35+3x25/3	39,5	1248	2300	3250	2
02010MR1037M65	3x50+3x25/3	42,5	1680	2860	4375	0
02010MR1037M66	3x70+3x35/3	46,5	2352	3800	6125	2/0
02010MR1037M67	3x95+3x50/3	51,2	3216	4700	8375	3/0
02010MR1037M68	3x120+3x70/3	55,7	4128	5900	10750	4/0
02010MR1037M69	3x150+3x70/3	59,5	4992	6950	13000	250 MCM
02010MR1037M70	3x185+3x95/3	-	6240	-	16250	350 MCM
02010MR1037M71	3x240+3x120/3	-	8064	-	21000	450 MCM
02010MR1037M72	3x300+3x150/3	-	10080	-	26250	600 MCM

6/10 kV (12) kV

Part no.	No. of cores x cross section n x mm ²	Outer-Ø ca.mm ± 10%	Copper weight kg/km	Cable weight approx. kg/km	Tensile strenght N	AWG no.®)
02010QR1037M63	3x25+3x25/3	35	960	1900	2500	4
02010QR1037M64	3x35+3x25/3	39,5	1248	2300	3250	2
02010QR1037M65	3x50+3x25/3	42,5	1680	2860	4375	0
02010QR1037M66	3x70+3x35/3	46,5	2352	3800	6125	2/0
02010QR1037M67	3x95+3x50/3	51,2	3216	4700	8375	3/0
02010QR1037M68	3x120+3x70/3	55,7	4128	5900	10750	4/0
02010QR1037M69	3x150+3x70/3	59,5	4992	6950	13000	250 MCM
02010QR1037M70	3x185+3x95/3	-	6240	-	16250	350 MCM
02010QR1037M71	3x240+3x120/3	-	8064	-	21000	450 MCM
02010QR1037M72	3x300+3x150/3	-	10080	-	26250	600 MCM

8,7/15 kV (7,2) kV

Part no.	No. of cores x cross section n x mm ²	Outer-Ø ca.mm ± 10%	Copper weight kg/km	Cable weight approx. kg/km	Tensile strenght N	AWG no.®)
02010SR1037M63	3x25+3x25/3	35	960	1900	2500	4
02010SR1037M64	3x35+3x25/3	39,5	1248	2300	3250	2
02010SR1037M65	3x50+3x25/3	42,5	1680	2860	4375	0
02010SR1037M66	3x70+3x35/3	46,5	2352	3800	6125	2/0
02010SR1037M67	3x95+3x50/3	51,2	3216	4700	8375	3/0
02010SR1037M68	3x120+3x70/3	55,7	4128	5900	10750	4/0
02010SR1037M69	3x150+3x70/3	59,5	4992	6950	13000	250 MCM
02010SR1037M70	3x185+3x95/3	-	6240	-	16250	350 MCM
02010SR1037M71	3x240+3x120/3	-	8064	-	21000	450 MCM
02010SR1037M72	3x300+3x150/3	-	10080	-	26250	600 MCM

12/20 kV (24) kV

Part no.	No. of cores x cross section n x mm ²	Outer-Ø ca.mm ± 10%	Copper weight kg/km	Cable weight approx. kg/km	Tensile strenght N	AWG no.®)
02010UR1037M63	3x25+3x25/3	45,5	960	2650	2500	4
02010UR1037M64	3x35+3x25/3	46	1248	2900	3250	2
02010UR1037M65	3x50+3x25/3	47,2	1680	3300	4375	0
02010UR1037M66	3x70+3x35/3	51,5	2352	4300	6125	2/0
02010UR1037M67	3x95+3x50/3	54,7	3216	5100	8375	3/0

Other dimensions and colors available on request.

CABLE REELS

FLEXIDRUM® MEDIUM R 902 OPTICAL FIBER

ELETTROTEK KABEL® FLEXIDRUM® MEDIUM R 902 OPTICAL FIBER



Construction:

Conductor:	flexible red copper conductor Cl. 5, acc. to IEC 60228, DIN VDE 0295
Inner semi-conductive layer:	semi-conducting compound
Insulation:	rubber EPR special compound
Outer semi-conductive layer:	semi-conducting compound
Cores color:	Power: natural color with black semi-conducting compound Earth: black semi-conducting compound
Optical fibres element:	6 fiber optics, multimode 62.5/125 µm
Inner sheath:	PUR compound
Supporting screen:	anti-twisting protection of high-tech yarns
Outer sheath:	red (similar to RAL 3000) special PUR compound

Resistance:



Self-extinguishing and flame retardant acc. to:
DIN VDE 0482 part 265-2-1
EN 50265-2-1
IEC 60332-1-2

Technical data:

Nominal voltage:	U/oU 3,6/6 kV up to 12/20 kV
Temperature range:	
<i>Fixed laying:</i>	-40°C up to +80°C
<i>Flexible installation:</i>	-25°C up to +80°C
Max. temperature on conductor:	+ 90°C
Max. temperature in short circuit:	+ 250 °C
Min. bending radius:	acc. to DIN VDE 0298 part 3
Tensile strength:	25 N per mm ²
Max speed (main application):	120 m/min

Features:

mining excavator!
outdoor use
UV, ozone, moisture resistant
oil resistance: very good
small outer diameter
reduced cable weight
possible without anti-twisting reinforcement
for SPEED and MINIMUM BENDING RADIUS
see pages from 2 to 8 of catalogue
RoHS approval



CABLE REELS

FLEXIDRUM® MEDIUM R 902 OPTICAL FIBER

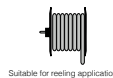

3,6/6 kV (7,2) kV

Part no.	No. of cores x cross section n x mm ²	Outer-Ø ca.mm ± 10%	Copper weight kg/km	Cable weight approx. kg/km	Tensile strenght N	AWG no.®)
02020MR1037M63	3x25+2x25/2+FO	35	960	1900	2500	4
02020MR1037M64	3x35+2x25/2+FO	39,5	1248	2300	3250	2
02020MR1037M65	3x50+2x25/2+FO	42,5	1680	2860	4375	0
02020MR1037M66	3x70+2x35/2+FO	46,5	2352	3800	6125	2/0
02020MR1037M67	3x95+2x50/2+FO	51,2	3216	4700	8375	3/0
02020MR1037M68	3x120+2x70/2+FO	55,7	4128	5900	10750	4/0
02020MR1037M69	3x150+2x70/2+FO	59,5	4992	6950	13000	250 MCM
02020MR1037M70	3x185+2x95/2+FO	-	6240	-	16250	350 MCM
02020MR1037M71	3x240+2x120/2+FO	-	8064	-	21000	450 MCM
02020MR1037M72	3x300+2x150/2+FO	-	10080	-	26250	600 MCM

6/10 kV (12) kV

Part no.	No. of cores x cross section n x mm ²	Outer-Ø ca.mm ± 10%	Copper weight kg/km	Cable weight approx. kg/km	Tensile strenght N	AWG no.®)
02020QR1037M63	3x25+2x25/2+FO	35	960	1900	2500	4
02020QR1037M64	3x35+2x25/2+FO	39,5	1248	2300	3250	2
02020QR1037M65	3x50+2x25/2+FO	42,5	1680	2860	4375	0
02020QR1037M66	3x70+2x35/2+FO	46,5	2352	3800	6125	2/0
02020QR1037M67	3x95+2x50/2+FO	51,2	3216	4700	8375	3/0
02020QR1037M68	3x120+2x70/2+FO	55,7	4128	5900	10750	4/0
02020QR1037M69	3x150+2x70/2+FO	59,5	4992	6950	13000	250 MCM
02020QR1037M70	3x185+2x95/2+FO	-	6240	-	16250	350 MCM
02020QR1037M71	3x240+2x120/2+FO	-	8064	-	21000	450 MCM
02020QR1037M72	3x300+2x150/2+FO	-	10080	-	26250	600 MCM

8,7/15 kV (18) kV

Part no.	No. of cores x cross section n x mm ²	Outer-Ø ca.mm ± 10%	Copper weight kg/km	Cable weight approx. kg/km	Tensile strenght N	AWG no.®)
02020SR1037M63	3x25+2x25/2+FO	35	960	1900	2500	4
02020SR1037M64	3x35+2x25/2+FO	39,5	1248	2300	3250	2
02020SR1037M65	3x50+2x25/2+FO	42,5	1680	2860	4375	0
02020SR1037M66	3x70+2x35/2+FO	46,5	2352	3800	6125	2/0
02020SR1037M67	3x95+2x50/2+FO	51,2	3216	4700	8375	3/0
02020SR1037M68	3x120+2x70/2+FO	55,7	4128	5900	10750	4/0
02020SR1037M69	3x150+2x70/2+FO	59,5	4992	6950	13000	250 MCM
02020SR1037M70	3x185+2x95/2+FO	-	6240	-	16250	350 MCM
02020SR1037M71	3x240+2x120/2+FO	-	8064	-	21000	450 MCM
02020SR1037M72	3x300+2x150/2+FO	-	10080	-	26250	600 MCM

12/20 kV (24) kV

Part no.	No. of cores x cross section n x mm ²	Outer-Ø ca.mm ± 10%	Copper weight kg/km	Cable weight approx. kg/km	Tensile strenght N	AWG no.®)
02020UR1037M63	3x25+2x25/2+FO	45,5	960	2650	2500	4
02020UR1037M64	3x35+2x25/2+FO	46	1248	2900	3250	2
02020UR1037M65	3x50+2x25/2+FO	47,2	1680	3300	4375	0
02020UR1037M66	3x70+2x35/2+FO	51,5	2352	4300	6125	2/0
02020UR1037M67	3x95+2x50/2+FO	54,7	3216	5100	8375	3/0

Other dimensions and colors available on request.

CABLE REELS

FLEXIDRUM® MEDIUM R 90 I

From 8,7/15 Kv up to 12/20 Kv

ELETTROTEK KABEL® FLEXIDRUM® R 90 I



Suitable for reeling application

Suitable for festoon application

Construction:

Conductor:	flexible red copper conductor Cl. 5, acc. to IEC 60228, DIN VDE 0295
Inner semi-conductive layer:	semi-conducting compound
Insulation:	rubber EPR special compound
Outer semi-conductive layer:	semi-conducting compound
Core color:	natural color with black semi-conducting compound
Screen:	red copper braid
Outer sheath:	red (similar to RAL 3000) special PUR compound

Technical data:

Nominal voltage:	U/oU 8,7/15 kV up to 12/20 kV
Temperature range:	
<i>Fixed laying:</i>	-50°C up to +80°C
<i>Flexible installation:</i>	-30°C up to +80°C
Max. temperature on conductor:	+ 90°C
Max. temperature in short circuit:	+ 250 °C
Tensile strenght:	≤ 20 N mm ²
Max speed (main application):	60 m/min.

Resistance:



Self-extinguishing and flame retardant acc. to:

DIN VDE 0482 part 265-2-1
EN 50265-2-1
IEC 60332-1-2

Features:

tunneling machines!

- on request other voltages
- outdoor use
- UV, ozone and water resistant
- oil resistant
- small outer diameter
- reduced cable weight
- possible without anti-twisting reinforcement
- for SPEED and MINIMUM BENDING RADIUS see pages from 2 to 8 of catalogue

RoHS approval



Applications:

FLEXIDRUM® MEDIUM R 90 I is used in reel, festoon and flexible/ fixed applications

8,7/15 kV (18) kV

Part no.	No. of cores x cross section n x mm ²	Outer-Ø ca.mm ± 10%	Cable weight approx. kg/km	Tensile strenght N	AWG no.®)
02030SRL010M63	1x25	18,5	550	500	4
02030SRL010M64	1x35	20	680	700	2
02030SRL010M65	1x50	21	880	1000	1
02030SRL010M66	1x70	23,3	1170	1400	2/0
02030SRL010M67	1x95	25,3	1500	1900	3/0
02030SRL010M68	1x120	27,3	1840	2400	4/0
02030SRL010M69	1x150	29,25	2230	3000	250 MCM

12/20 kV (24) kV

Part no.	No. of cores x cross section n x mm ²	Outer-Ø ca.mm ± 10%	Cable weight approx. kg/km	Tensile strenght N	AWG no.®)
02030URL010M63	1x25	22	550	500	4
02030URL010M64	1x35	22,5	680	700	2
02030URL010M65	1x50	23	880	1000	1
02030URL010M66	1x70	25,5	1170	1400	2/0
02030URL010M67	1x95	27	1500	1900	3/0
02030URL010M68	1x120	28,75	1840	2400	4/0
02030URL010M69	1x150	30,25	2230	3000	250 MCM

Other dimensions and colors available on request.

CABLE REELS

FLEXIDRUM® MEDIUM (N)TSCGEWÖU

From 3,6/6 Kv up to 20/35 Kv with antitwisting protection

ELETTROTEK KABEL® FLEXIDRUM® MEDIUM (N)TSCGEWÖU

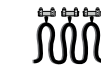

Suitable for reeling application

Suitable for festoon application

Construction:

Conductor:	flexible tinned copper conductor Cl. 5, acc. to IEC 60228, DIN VDE 0295
Inner semi-conductive layer:	semi-conducting compound
Insulation:	rubber EPR type 3GI3
Outer semi-conductive layer:	
Earth Conductor:	flexible tinned copper conductor Cl. 5, acc. to IEC 60228, DIN VDE 0295
Earth semi-conductive layer:	semi-conducting compound
Cores color:	Power: natural color with black semi-conducting compound Earth: black semi-conducting compound
Stranding:	phase units laid up with earth-conductors in interstices
Inner sheath:	rubber PCP type 5GM3
Supporting screen:	anti-twisting protection of synthetic yarns
Outer sheath:	red (similar to RAL 3000) rubber PCP type 5GM5

Resistance:



Self-extinguishing and flame retardant acc. to:
DIN VDE 0482 part 265-2-1
EN 50265-2-1
IEC 60332-1-2



Oil resistance acc. to:
DIN VDE 0473 part 811-2-1
IEC EN 60811-2-1

Technical data:

Nominal voltage:	U/oU 3,6/6 kV, U/oU 6/10 kV U/oU 8,7/15, U/oU 12/20 kV 20/35 kV
Max. operating voltage:	U/oU 3,6/6 kV = 7,2 kV U/oU 6/10 kV = 12 kV U/oU 8,7/15 = 18 kV U/oU 12/20 kV = 24 kV U/oU 20/35 kV = 42 kV
Test voltage:	U/oU 3,6/6 kV = 11 kV U/oU 6/10 kV = 17 kV U/oU 8,7/15 = 24 kV U/oU 12/20 kV = 29 kV U/oU 20/35 kV = 50 kV
Temperature range:	
<i>Fixed laying:</i>	-40°C up to +80°C
<i>Flexible installation:</i>	-30°C up to +60°C
Max. temperature on conductor:	+ 90°C
Max. temperature in short circuit:	+ 250 °C
Min. bending radius:	
<i>Fixed laying:</i>	6 x d
<i>On drums:</i>	12 x D
<i>On deflection pulley:</i>	15 x D
<i>Free movement:</i>	12 x D
Min. distance for change of direction:	20 x D
Max speed (main application):	180 m/min
Max torsion:	± 25°/m

Features:

new version reduced weight and diameter!

on request cold version up to - 45°C

for SPEED and MINIMUM BENDING RADIUS see pages from 2 to 8 of catalogue

RoHS approval



Applications:

power supply to mobile units with high risk of mechanical damage. It is designed to work with forced guidance systems with deflection on different floors and equipment with reel axis in direction of travel

CABLE REELS

FLEXIDRUM® MEDIUM (N)TSCGEWÖU

From 3,6/6 Kv up to 20/35 Kv with antitwisting protection



3,6/6 kV (7,2) kV

Part no.	No. of cores x cross section n x mm ²	Outer-Ø ca.mm ± 10%	Copper weight kg/km	Cable weight approx. kg/km	Tensile strenght N	AWG no.®)
02040MR1037M63	3x25+3x25/3	40	960	2450	1500	4
02040MR1037M64	3x35+3x25/3	42,7	1248	2960	2100	2
02040MR1037M65	3x50+3x25/3	45,5	1680	3495	3000	1
02040MR1037M66	3x70+3x35/3	49,6	2352	4450	4200	2/0
02040MR1037M67	3x95+3x50/3	54,7	3216	5545	5700	3/0
02040MR1037M68	3x120+3x70/3	59	4128	6920	7200	4/0
02040MR1037M69	3x150+3x70/3	64,7	4992	8180	9000	250 MCM
02040MR1037M70	3x185+3x95/3	68,8	6240	9730	11100	350 MCM
02040MR1037M71	3x240+3x120/3	75,9	8064	12445	14400	450 MCM

6/10 kV (12) kV

Part no.	No. of cores x cross section n x mm ²	Outer-Ø ca.mm ± 10%	Copper weight kg/km	Cable weight approx. kg/km	Tensile strenght N	AWG no.®)
02040QR1037M63	3x25+3x25/3	40,9	960	2520	1500	4
02040QR1037M64	3x35+3x25/3	43,5	1248	3040	2100	2
02040QR1037M65	3x50+3x25/3	46,5	1680	3570	3000	1
02040QR1037M66	3x70+3x35/3	50,4	2352	4540	4200	2/0
02040QR1037M67	3x95+3x50/3	55,5	3216	5665	5700	3/0
02040QR1037M68	3x120+3x70/3	59,8	4128	7028	7200	4/0
02040QR1037M69	3x150+3x70/3	65,5	4992	8300	9000	250 MCM
02040QR1037M70	3x185+3x95/3	69,4	6240	9805	11100	350 MCM
02040QR1037M71	3x240+3x120/3	76,8	8064	12590	14400	450 MCM

8,7/15 kV (18) kV

Part no.	No. of cores x cross section n x mm ²	Outer-Ø ca.mm ± 10%	Copper weight kg/km	Cable weight approx. kg/km	Tensile strenght N	AWG no.®)
02040SR1037M63	3x25+3x25/3	44,3	960	2820	1500	4
02040SR1037M64	3x35+3x25/3	47	1248	3370	2100	2
02040SR1037M65	3x50+3x25/3	49,8	1680	3935	3000	1
02040SR1037M66	3x70+3x35/3	55,1	2352	5070	4200	2/0
02040SR1037M67	3x95+3x50/3	59	3216	6085	5700	3/0
02040SR1037M68	3x120+3x70/3	64,9	4128	7715	7200	4/0
02040SR1037M69	3x150+3x70/3	69	4992	8790	9000	250 MCM
02040SR1037M70	3x185+3x95/3	72	6240	10215	11100	350 MCM
02040SR1037M71	3x240+3x120/3	79,4	8064	13010	14400	450 MCM

12/20 kV (24) kV

Part no.	No. of cores x cross section n x mm ²	Outer-Ø ca.mm ± 10%	Copper weight kg/km	Cable weight approx. kg/km	Tensile strenght N	AWG no.®)
02040UR1037M63	3x25+3x25/3	49,5	960	3340	1500	4
02040UR1037M64	3x35+3x25/3	53,4	1248	4060	2100	2
02040UR1037M65	3x50+3x25/3	56,2	1680	4650	3000	1
02040UR1037M66	3x70+3x35/3	60,3	2352	5720	4200	2/0
02040UR1037M67	3x95+3x50/3	65,7	3216	7010	5700	3/0
02040UR1037M68	3x120+3x70/3	70	4128	8460	7200	4/0
02040UR1037M69	3x150+3x70/3	75,9	4992	9880	9000	250 MCM
02040UR1037M70	3x185+3x95/3	79	6240	11360	11100	350 MCM
02040UR1037M71	3x240+3x120/3	84,6	8064	13870	14400	450 MCM

20/35 kV (42) kV

Part no.	No. of cores x cross section n x mm ²	Outer-Ø ca.mm ± 10%	Copper weight kg/km	Cable weight approx. kg/km	Tensile strenght N	AWG no.®)
02040YR1037M66	3x70+3x35/3	82	2352	9260	4200	2/0

Other dimensions and colors available on request.

CABLE REELS

FLEXIDRUM® MEDIUM (N)TSCGEWÖU

From 3,6/6 Kv up to 20/35 Kv with antitwisting protection

ELETTROTEK KABEL® FLEXIDRUM® MEDIUM (N)TSCGEWÖU



Suitable for reeling application



Suitable for festoon application

Nominal cross section mm ²	Max resistance		Reactance at 50 Hz for nominal voltage			
	D.C. at 20°C Ohm/km	A.C. at 90°C Ohm/km	3,6/6 Ohm/km	6/10 Ohm/km	8,7/15 Ohm/km	12/20 Ohm/km
25	0,780	0,995	0,106	0,107	0,114	0,123
35	0,554	0,707	0,100	0,101	0,107	0,116
50	0,386	0,493	0,095	0,097	0,102	0,110
70	0,272	0,348	0,090	0,092	0,097	0,104
95	0,206	0,264	0,087	0,088	0,093	0,099
120	0,161	0,207	0,084	0,085	0,089	0,095
150	0,129	0,167	0,082	0,083	0,087	0,092
185	0,106	0,139	0,080	0,081	0,085	0,090
240	0,0801	0,107	0,079	0,079	0,083	0,087

Correction factors for ambient temperature other than 30°C

°C	20	25	30	40	45	50	55
K	1,1	1,05	0,95	0,89	0,84	0,77	0,71

CABLE REELS

FLEXIDRUM® MEDIUM (N)TSCGEWÖU OPTICAL FIBER

From 3,6/6 Kv up to 20/35 Kv with antitwisting protection and optical element



Suitable for reeling application



Suitable for festoon application

Construction:

Conductor:	flexible tinned copper conductor Cl. 5, acc. to IEC 60228, DIN VDE 0295
Inner semi-conductive layer:	semi-conducting compound
Insulation:	rubber EPR type 3GI3
Outer semi-conductive layer:	semi-conducting compound
Earth Conductor:	Flexible tinned copper conductor Cl. 5, acc. to IEC 60228, DIN VDE 0295
Earth semi-conductive layer:	semi-conducting compound
Cores color:	Power: natural color with black semi-conducting compound Earth: black semi-conducting compound
Optical fibers element:	6-12-18 fiber-optics laying in 6 free tubes (1,2 or 3 fibers per tube)
Stranding:	phase units laid up with earth-conductors and fiber optics in interstices
Inner sheath:	rubber PCP type 5GM3
Supporting screen:	anti-twisting protection of synthetic yarns
Outer sheath:	red (similar to RAL 3000) rubber PCP type 5GM5

Resistance:



Self-extinguishing and flame retardant acc. to:
DIN VDE 0482 part 265-2-1
EN 50265-2-1
IEC 60332-1-2



Oil resistance acc. to:
DIN VDE 0473 part 811-2-1
IEC EN 60811-2-1

Technical data:

Nominal voltage:	U/oU 3,6/6 kV, U/oU 6/10 kV U/oU 8,7/15, U/oU 12/20 kV, 20/35 kV
Max. operating voltage:	U/oU 3,6/6 kV = 7,2 kV U/oU 6/10 kV = 12 kV U/oU 8,7/15 = 18 kV U/oU 12/20 kV = 24 kV U/oU 20/35 kV = 42 kV
Test voltage:	U/oU 3,6/6 kV = 11 kV U/oU 6/10 kV = 17 kV U/oU 8,7/15 = 24 kV U/oU 12/20 kV = 29 kV U/oU 20/35 kV = 50 kV
Temperature range:	
<i>Fixed laying:</i>	-40°C up to +80°C
<i>Flexible installation:</i>	-30°C up to +60°C
Max. temperature on conductor:	+ 90°C
Max. temperature in short circuit:	+ 250 °C
Min. bending radius:	
<i>Fixed laying:</i>	6 x d
<i>On drums:</i>	12 x D
<i>On deflection pulley:</i>	15 x D
<i>Free movement:</i>	12 x D
Min. distance for change of direction:	20 x D
Max speed (main application):	180 m/min
Max torsion:	± 25°/m

Features:

new version reduced weight and diameter!

on request cold version up to -45°C

for SPEED and MINIMUM BENDING RADIUS see pages from 2 to 8 of catalogue

RoHS approval



Applications:

power supply to mobile units with high risk of mechanical damage. It is designed to work with forced guidance systems with deflection on different floors and equipment with reel axis in direction of travel

CABLE REELS

FLEXIDRUM® MEDIUM (N)TSCGEWÖU OPTICAL FIBER

From 3,6/6 Kv up to 20/35 Kv with antitwisting protection and optical element



Suitable for reeling application



Suitable for lession application

3,6/6 kV (7,2) kV

Part no.	No. of cores x cross section n x mm ²	Outer-Ø ca.mm ± 10%	Copper weight kg/km	Cable weight approx. kg/km	Tensile strenght N	AWG no.®)
02050MR1037M63	3x25+2x25/2+FO	40,3	960	2495	1500	4
02050MR1037M64	3x35+2x25/2+FO	42,7	1248	2990	2100	2
02050MR1037M65	3x50+2x25/2+FO	45,5	1680	3520	3000	1
02050MR1037M66	3x70+2x35/2+FO	49,6	2352	4518	4200	2/0
02050MR1037M67	3x95+2x50/2+FO	54,7	3216	5590	5700	3/0
02050MR1037M68	3x120+2x70/2+FO	58,9	4128	6960	7200	4/0
02050MR1037M69	3x150+2x70/2+FO	64,7	4992	8200	9000	250 MCM
02050MR1037M70	3x185+2x95/2+FO	68,4	6240	9770	11100	350 MCM
02050MR1037M71	3x240+2x120/2+FO	78,1	8064	12790	14400	450 MCM

6/10 kV (12) kV

Part no.	No. of cores x cross section n x mm ²	Outer-Ø ca.mm ± 10%	Copper weight kg/km	Cable weight approx. kg/km	Tensile strenght N	AWG no.®)
02050QR1037M63	3x25+2x25/2+FO	41	960	2550	1500	4
02050QR1037M64	3x35+2x25/2+FO	43,5	1248	3070	2100	2
02050QR1037M65	3x50+2x25/2+FO	46,3	1680	3600	3000	1
02050QR1037M66	3x70+2x35/2+FO	50,3	2352	4584	4200	2/0
02050QR1037M67	3x95+2x50/2+FO	55,5	3216	5690	5700	3/0
02050QR1037M68	3x120+2x70/2+FO	59,6	4128	7050	7200	4/0
02050QR1037M69	3x150+2x70/2+FO	65,3	4992	8834	9000	250 MCM
02050QR1037M70	3x185+2x95/2+FO	69,0	6240	9840	11100	350 MCM
02050QR1037M71	3x240+2x120/2+FO	78,8	8064	12890	14400	450 MCM

8,7/15 kV (18) kV

Part no.	No. of cores x cross section n x mm ²	Outer-Ø ca.mm ± 10%	Copper weight kg/km	Cable weight approx. kg/km	Tensile strenght N	AWG no.®)
02050SR1037M63	3x25+2x25/2+FO	47	960	2850	1500	4
02050SR1037M64	3x35+2x25/2+FO	48,2	1248	3404	2100	2
02050SR1037M65	3x50+2x25/2+FO	49,8	1680	3970	3000	1
02050SR1037M66	3x70+2x35/2+FO	55,1	2352	5140	4200	2/0
02050SR1037M67	3x95+2x50/2+FO	59	3216	6125	5700	3/0
02050SR1037M68	3x120+2x70/2+FO	64,9	4128	7786	7200	4/0
02050SR1037M69	3x150+2x70/2+FO	69	4992	8830	9000	250 MCM
02050SR1037M70	3x185+2x95/2+FO	72	6240	10268	11100	350 MCM
02050SR1037M71	3x240+2x120/2+FO	80,7	8064	13207	14400	450 MCM

12/20 kV (24) kV

Part no.	No. of cores x cross section n x mm ²	Outer-Ø ca.mm ± 10%	Copper weight kg/km	Cable weight approx. kg/km	Tensile strenght N	AWG no.®)
02050UR1037M63	3x25+2x25/2+FO	49,5	960	3380	1500	4
02050UR1037M64	3x35+2x25/2+FO	53,4	1248	4095	2100	2
02050UR1037M65	3x50+2x25/2+FO	57,2	1680	4675	3000	1
02050UR1037M66	3x70+2x35/2+FO	60,3	2352	5807	4200	2/0
02050UR1037M67	3x95+2x50/2+FO	65,7	3216	7040	5700	3/0
02050UR1037M68	3x120+2x70/2+FO	70	4128	8530	7200	4/0
02050UR1037M69	3x150+2x70/2+FO	75,9	4992	9935	9000	250 MCM
02050UR1037M70	3x185+2x95/2+FO	79	6240	11395	11100	350 MCM
02050UR1037M71	3x240+2x120/2+FO	84,6	8064	13915	14400	450 MCM

20/35 kV (42) kV

Part no.	No. of cores x cross section n x mm ²	Outer-Ø ca.mm ± 10%	Copper weight kg/km	Cable weight approx. kg/km	Tensile strenght N	AWG no.®)
02050YR1037M66	3x70+2x35/2+FO	82	2352	9260	4200	2/0

Other dimensions and colors available on request.

CABLE REELS

FLEXIDRUM® MEDIUM (N)TSCGEWÖU OPTICAL FIBER

From 3,6/6 Kv up to 20/35 Kv with antitwisting protection and optical element



ELETTROTEK KABEL® FLEXIDRUM® MEDIUM (N)TSCGEWÖU OPTICAL FIBER



Suitable for reeling application



Suitable for festoon application

Nominal cross section mm ²	Max resistance		Reactance at 50 Hz for nominal voltage			
	D.C. at 20°C Ohm/km	A.C. at 90°C Ohm/km	3,6/6 Ohm/km	6/10 Ohm/km	8,7/15 Ohm/km	12/20 Ohm/km
25	0,780	0,995	0,106	0,107	0,114	0,123
35	0,554	0,707	0,100	0,101	0,107	0,116
50	0,386	0,493	0,095	0,097	0,102	0,110
70	0,272	0,348	0,090	0,092	0,097	0,104
95	0,206	0,264	0,087	0,088	0,093	0,099
120	0,161	0,207	0,084	0,085	0,089	0,095
150	0,129	0,167	0,082	0,083	0,087	0,092
185	0,106	0,139	0,080	0,081	0,085	0,090
240	0,0801	0,107	0,079	0,079	0,083	0,087

Correction factors for ambient temperature other than 30°C

°C	20	25	30	40	45	50	55
K	1,1	1,05	0,95	0,89	0,84	0,77	0,71

Optical parameters:

Transmission data of the fiber-optics	Graded-index fiber 50/125	Graded-index fiber 62.5/125	Monomode fiber E9/125
Max attenuation at wavelength 850 m	2,8 dB/km	3,3 dB/km	-
Max attenuation at wavelength 1300 m	0,8 dB/km	0,4 dB/km	0,9 dB/km
Max attenuation at wavelength 1550 m	-	-	0,3 dB/km
Bandwidth at 850 nm	>400 MHz	>400 MHz	-
Bandwidth at 1300 nm	>1200 MHz	>600 MHz	-
Numerical aperture	0,200+/-0,200	0,275+/-0,02	0,14+/-0,02
Chromatic dispersion at 1300 nm	-	-	<3,5 ps/nm km
Chromatic dispersion at 1550 nm	-	-	<3,5 ps/nm km

CABLE REELS

FLEXIDRUM® MEDIUM PLUS (N)TSCGEWÖU

From 3,6/6 Kv up to 12/20 Kv with antitwisting protection



Suitable for reeling application



Suitable for deflection application

Construction:

Conductor:	flexible red copper conductor Cl. 5, acc. to IEC 60228, DIN VDE 0295
Inner semi-conductive layer:	semi-conducting compound
Insulation:	rubber EPR type 3GI3
Outer semi-conductive layer:	semi-conducting compound
Earth Conductor:	Flexible red copper conductor Cl. 5, acc. to IEC 60228, DIN VDE 0295
Earth semi-conductive layer:	semi-conducting compound
Cores color:	Power: natural color with black semi-conducting compound Earth: black semi-conducting compound
Central unit:	semi-conducting rubber compound
Stranding:	phase units laid up with earth-conductors in interstices
Inner sheath:	rubber EPR type GM1b
Supporting screen:	anti-twisting protection of synthetic yarns
Outer sheath:	red (similar to RAL 3000) rubber PCP type 5GM5

Resistance:



Self-extinguishing and flame retardant acc. to:

DIN VDE 0482 part 265-2-1
EN 50265-2-1
IEC 60332-1-2



Oil resistance acc. to:

DIN VDE 0473 part 811-2-1
IEC EN 60811-2-1

Technical data:

Nominal voltage:	U/oU 3,6/6 kV, U/oU 6/10 kV U/oU 8,7/15, U/oU 12/20 kV
Max. operating voltage:	U/oU 3,6/6 kV = 7,2 kV U/oU 6/10 kV = 12 kV U/oU 8,7/15 = 18 kV U/oU 12/20 kV = 24 kV
Test voltage:	U/oU 3,6/6 kV = 11 kV U/oU 6/10 kV = 17 kV U/oU 8,7/15 = 24 kV U/oU 12/20 kV = 29 kV
Temperature range:	
<i>Fixed laying:</i>	-50°C up to +80°C
<i>Flexible installation:</i>	-35°C up to +80°C
Max. temperature on conductor:	+ 90°C
Max. temperature in short circuit:	+ 250 °C
Min. bending radius:	
<i>Fixed laying:</i>	6 x D
<i>On drums:</i>	12 x D
<i>On deflection pulley:</i>	15 x D
Min. distance for change of direction:	20 x D
Max speed (main application):	300 m/min
Max torsion:	± 25°/m

Features:

max. speed up to 300 m/min!

new version reduced weight and diameter!

acc. to DIN VDE 0250 part 813, and 0298-3/4

UL and MSHA approval on request

*after verify of the application by Elettrotek Kabel

for SPEED and MINIMUM BENDING RADIUS
see pages from 2 to 8 of catalogue

RoHS approval



Applications:

power supply to mobile units with high risk of mechanical damage. It is designed to work with forced guidance systems with deflection on different floors and equipment with reel axis in direction of travel

CABLE REELS

FLEXIDRUM® MEDIUM PLUS (N)TSCGEWÖU

From 3,6/6 Kv up to 12/20 Kv with antitwisting protection

ELETTROTEK KABEL® FLEXIDRUM® MEDIUM PLUS (N)TSCGEWÖU



Suitable for reeling application



Suitable for festoon application

3,6/6 kV (7,2) kV

Part no.	No. of cores x cross section n x mm ²	Outer-Ø ca.mm ± 10%	Copper weight kg/km	Cable weight approx. kg/km	Tensile strenght N	AWG no.®)
02045MR1037M63	3x25+3x25/3	42	960	2540	3000	4
02045MR1037M64	3x35+3x25/3	43,5	1248	2825	3000	2
02045MR1037M65	3x50+3x25/3	47,5	1680	3560	3000	1
02045MR1037M66	3x70+3x35/3	51,5	2352	4370	4200	2/0
02045MR1037M67	3x95+3x50/3	56	3216	5470	5700	3/0
02045MR1037M68	3x120+3x70/3	59,5	4156	6500	7200	4/0
02045MR1037M69	3x150+3x70/3	65,5	4992	7830	9000	250 MCM
02045MR1037M70	3x185+3x95/3	69,5	6240	9370	11100	350 MCM
02045MR1037M71	3x240+3x95/3	74,5	7824	11360	14400	450 MCM

6/10 kV (12) kV

Part no.	No. of cores x cross section n x mm ²	Outer-Ø ca.mm ± 10%	Copper weight kg/km	Cable weight approx. kg/km	Tensile strenght N	AWG no.®)
02045QR1037M63	3x25+3x25/3	42	960	2540	3000	4
02045QR1037M64	3x35+3x25/3	43,5	1248	2825	3000	2
02045QR1037M65	3x50+3x25/3	47,5	1680	3560	3000	1
02045QR1037M66	3x70+3x35/3	51,5	2352	4370	4200	2/0
02045QR1037M67	3x95+3x50/3	56	3216	5470	5700	3/0
02045QR1037M68	3x120+3x70/3	59,5	4156	6500	7200	4/0
02045QR1037M69	3x150+3x70/3	65,5	4992	7830	9000	250 MCM
02045QR1037M70	3x185+3x95/3	69,5	6240	9370	11100	350 MCM
02045QR1037M71	3x240+3x95/3	74,5	7824	11360	14400	450 MCM

8,7/15 kV (18) kV

Part no.	No. of cores x cross section n x mm ²	Outer-Ø ca.mm ± 10%	Copper weight kg/km	Cable weight approx. kg/km	Tensile strenght N	AWG no.®)
02045SR1037M63	3x25+3x25/3	42	960	2540	3000	4
02045SR1037M64	3x35+3x25/3	43,5	1248	2825	3000	2
02045SR1037M65	3x50+3x25/3	47,5	1680	3560	3000	1
02045SR1037M66	3x70+3x35/3	51,5	2352	4370	4200	2/0
02045SR1037M67	3x95+3x50/3	56	3216	5470	5700	3/0
02045SR1037M68	3x120+3x70/3	59,5	4156	6500	7200	4/0
02045SR1037M69	3x150+3x70/3	65,5	4992	7830	9000	250 MCM
02045SR1037M70	3x185+3x95/3	69,5	6240	9370	11100	350 MCM
02045SR1037M71	3x240+3x95/3	74,5	7824	11360	14400	450 MCM

12/20 kV (24) kV

Part no.	No. of cores x cross section n x mm ²	Outer-Ø ca.mm ± 10%	Copper weight kg/km	Cable weight approx. kg/km	Tensile strenght N	AWG no.®)
02045UR1037M63	3x25+3x25/3	47	960	2990	3000	4
02045UR1037M64	3x35+3x25/3	48,5	1248	3300	3000	2
02045UR1037M65	3x50+3x25/3	50,5	1680	3820	3000	1
02045UR1037M66	3x70+3x35/3	56,5	2352	4880	4200	2/0
02045UR1037M67	3x95+3x50/3	61	3216	5950	5700	3/0
02045UR1037M68	3x120+3x70/3	63,5	4156	7000	7200	4/0
02045UR1037M69	3x150+3x70/3	67,5	4992	8250	9000	250 MCM
02045UR1037M70	3x185+3x95/3	71,5	6240	9650	11100	350 MCM
02045UR1037M71	3x240+3x95/3	78,5	7824	12150	14400	450 MCM
02045UR1037M72	3x300+3x120/3	82	9792	14400	18000	550 MCM

Other dimensions and colors available on request.

CABLE REELS

FLEXIDRUM® MEDIUM PLUS (N)TSCGEWÖU

From 3,6/6 Kv up to 12/20 Kv with antitwisting protection



Suitable for reeling application



Suitable for festoon application

Nominal cross section mm ²	Max resistance		Reactance at 50 Hz for nominal voltage			
	D.C. at 20°C Ohm/km	A.C. at 90°C Ohm/km	3,6/6 Ohm/km	6/10 Ohm/km	8,7/15 Ohm/km	12/20 Ohm/km
25	0,780	0,995	0,106	0,107	0,114	0,123
35	0,554	0,707	0,100	0,101	0,107	0,116
50	0,386	0,493	0,095	0,097	0,102	0,110
70	0,272	0,348	0,090	0,092	0,097	0,104
95	0,206	0,264	0,087	0,088	0,093	0,099
120	0,161	0,207	0,084	0,085	0,089	0,095
150	0,129	0,167	0,082	0,083	0,087	0,092
185	0,106	0,139	0,080	0,081	0,085	0,090
240	0,0801	0,107	0,079	0,079	0,083	0,087

Correction factors for ambient temperature other than 30°C							
°C	20	25	30	40	45	50	55
K	1,1	1,05	0,95	0,89	0,84	0,77	0,71

CABLE REELS

FLEXIDRUM® MEDIUM PLUS (N)TSCGEWÖU OPTICAL FIBER

From 3,6/6 Kv up to 18/30 Kv with antitwisting protection and optical fiber

ELETTROTEK KABEL® FLEXIDRUM® MEDIUM PLUS (N)TSCGEWÖU OPTICAL FIBER

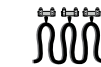

Suitable for reeling application

Suitable for festoon application

Construction:

Conductor:	flexible red copper conductor Cl. 5, acc. to IEC 60228, DIN VDE 0295
Inner semi-conductive layer:	semi-conducting compound
Insulation:	rubber EPR type 3GI3
Outer semi-conductive layer:	semi-conducting compound
Earth Conductor:	Flexible red copper conductor Cl. 5, acc. to IEC 60228, DIN VDE 0295
Earth semi-conductive layer:	semi-conducting compound
Cores color:	Power: natural color with black semi-conducting compound Earth: black semi-conducting compound
Fiber optics:	6/12/24 fiber-optics laid-up as below*: ≤35 mm²: 12 fibers laying in 1 reinforced tube ≥ 50 mm²: 6 fibers laying in 2 gel filled tubes * laid-up referred for 12 fiber-optics version
Central unit:	semi-conducting rubber compound
Stranding:	phase units laid up with earth-conductors and fiber optics in interstices
Inner sheath:	rubber EPR type GM1b
Supporting screen:	anti-twisting protection of synthetic yarns
Outer sheath:	red (similar to RAL 3000) rubber PCP type 5GM5

Resistance:



Self-extinguishing and flame retardant acc. to:
DIN VDE 0482 part 265-2-1
EN 50265-2-1
IEC 60332-1-2



Oil resistance acc. to:
DIN VDE 0473 part 811-2-1
IEC EN 60811-2-1

Technical data:

Nominal voltage:	U/oU 3,6/6 kV, U/oU 6/10 kV U/oU 8,7/15, U/oU 12/20 kV, U/oU 14/25 kV, U/oU 18/30 kV
Max. operating voltage:	U/oU 3,6/6 kV = 7,2 kV U/oU 6/10 kV = 12 kV U/oU 8,7/15 = 18 kV U/oU 12/20 kV = 24 kV U/oU 14/25 kV = 30 kV U/oU 18/30 kV = 36 kV
Test voltage:	U/oU 3,6/6 kV = 11 kV U/oU 6/10 kV = 17 kV U/oU 8,7/15 = 24 kV U/oU 12/20 kV = 29 kV U/oU 14/25 kV = 36 kV U/oU 18/30 kV = 43 kV
Temperature range:	
<i>Fixed laying:</i>	-50°C up to +80°C
<i>Flexible installation:</i>	-35°C up to +80°C
Max. temperature on conductor:	+ 90°C
Max. temperature in short circuit:	+ 250 °C
Min. bending radius:	
<i>Fixed laying:</i>	6 x D
<i>On drums:</i>	12 x D
<i>On deflection pulley:</i>	15 x D
Min. distance for change of direction:	20 x D
Max speed (main application):	300 m/min
Max torsion:	± 25°/m

Features:

max. speed up to 300 m/min!

new version reduced weight and diameter!

acc. to DIN VDE 0250 part 813, and 0298-3/4

UL and MSHA approval on request

*after verify of the application by Elektrotek Kabel

for SPEED and MINIMUM BENDING RADIUS
see pages from 2 to 8 of catalogue

RoHS approval



Applications:

power supply to mobile units with high risk of mechanical damage. It is designed to work with forced guidance systems with deflection on different floors and equipment with reel axis in direction of travel

CABLE REELS

FLEXIDRUM® MEDIUM PLUS (N)TSCGEWÖU OPTICAL FIBER

From 3,6/6 Kv up to 18/30 Kv with antitwisting protection and optical fiber



ELETTROTEK KABEL® FLEXIDRUM® MEDIUM PLUS (N)TSCGEWÖU OPTICAL FIBER



Suitable for reeling application



Suitable for festoon application

3,6/6 kV (7,2) kV

Part no.	No. of cores x cross section n x mm ²	Outer-Ø ca.mm ± 10%	Copper weight kg/km	Cable weight approx. kg/km	Tensile strenght N	AWG no.®)
02055MR1037M63	3x25+2x25/2+12FO	41,5	960	2600	1500	4
02055MR1037M64	3x35+2x25/2+12FO	43,5	1248	2840	2100	2
02055MR1037M65	3x50+2x25/2+12FO	47,5	1680	3550	3000	1
02055MR1037M66	3x70+2x35/2+12FO	51,5	2352	4350	4200	2/0
02055MR1037M67	3x95+2x50/2+12FO	56,5	3216	5470	5700	3/0
02055MR1037M68	3x120+2x70/2+12FO	60,5	4128	6490	7200	4/0
02055MR1037M69	3x150+2x70/2+12FO	65,5	4992	7980	9000	250 MCM
02055MR1037M70	3x185+2x95/2+12FO	69,5	6240	9450	11100	350 MCM
02055MR1037M71	3x240+2x120/2+12FO	75	8064	11590	14400	450 MCM

6/10 kV (12) kV

Part no.	No. of cores x cross section n x mm ²	Outer-Ø ca.mm ± 10%	Copper weight kg/km	Cable weight approx. kg/km	Tensile strenght N	AWG no.®)
02055QR1037M63	3x25+2x25/2+12FO	41,5	960	2600	1500	4
02055QR1037M64	3x35+2x25/2+12FO	43,5	1248	2840	2100	2
02055QR1037M65	3x50+2x25/2+12FO	47,5	1680	3550	3000	1
02055QR1037M66	3x70+2x35/2+12FO	51,5	2352	4350	4200	2/0
02055QR1037M67	3x95+2x50/2+12FO	56,5	3216	5470	5700	3/0
02055QR1037M68	3x120+2x70/2+12FO	60,5	4128	6490	7200	4/0
02055QR1037M69	3x150+2x70/2+12FO	65,5	4992	7980	9000	250 MCM
02055QR1037M70	3x185+2x95/2+12FO	69,5	6240	9450	11100	350 MCM
02055QR1037M71	3x240+2x120/2+12FO	75	8064	11590	14400	450 MCM

8,7/15 kV (18) kV

Part no.	No. of cores x cross section n x mm ²	Outer-Ø ca.mm ± 10%	Copper weight kg/km	Cable weight approx. kg/km	Tensile strenght N	AWG no.®)
02055SR1037M63	3x25+2x25/2+12FO	43,5	960	2600	1500	4
02055SR1037M64	3x35+2x25/2+12FO	44,5	1248	2840	2100	2
02055SR1037M65	3x50+2x25/2+12FO	47,5	1680	3550	3000	1
02055SR1037M66	3x70+2x35/2+12FO	51,5	2352	4350	4200	2/0
02055SR1037M67	3x95+2x50/2+12FO	56,5	3216	5470	5700	3/0
02055SR1037M68	3x120+2x70/2+12FO	60,5	4128	6490	7200	4/0
02055SR1037M69	3x150+2x70/2+12FO	65,5	4992	7980	9000	250 MCM
02055SR1037M70	3x185+2x95/2+12FO	69,5	6240	9450	11100	350 MCM
02055SR1037M71	3x240+2x120/2+12FO	75	8064	11590	14400	450 MCM

12/20 kV (24) kV

Part no.	No. of cores x cross section n x mm ²	Outer-Ø ca.mm ± 10%	Copper weight kg/km	Cable weight approx. kg/km	Tensile strenght N	AWG no.®)
02055UR1037M63	3x25+2x25/2+12FO	49,5	960	3160	1500	4
02055UR1037M64	3x35+2x25/2+12FO	50,5	1248	3480	2100	2
02055UR1037M65	3x50+2x25/2+12FO	51,5	1680	3900	3000	1
02055UR1037M66	3x70+2x35/2+12FO	56,5	2352	4950	4200	2/0
02055UR1037M67	3x95+2x50/2+12FO	59,5	3216	5900	5700	3/0
02055UR1037M68	3x120+2x70/2+12FO	62,5	4128	7000	7200	4/0
02055UR1037M69	3x150+2x70/2+12FO	67,5	4992	8210	9000	250 MCM
02055UR1037M70	3x185+2x95/2+12FO	71,5	6240	9680	11100	350 MCM
02055UR1037M71	3x240+2x120/2+12FO	78,5	8064	12180	14400	450 MCM

Other dimensions and colors available on request.

CABLE REELS

FLEXIDRUM® MEDIUM PLUS (N)TSCGEWÖU OPTICAL FIBER

From 3,6/6 Kv up to 18/30 Kv with antitwisting protection and optical fiber



Suitable for reeling application



Suitable for festoon application

14/25 kV (30) kV

Part no.	No. of cores x cross section n x mm ²	Outer-Ø ca.mm ± 10%	Copper weight kg/km	Cable weight approx. kg/km	Tensile strenght N	AWG no.*)
02055WR1037M63	3x25+2x25/2+12FO	55,5	960	3880	1500	4
02055WR1037M64	3x35+2x25/2+12FO	55,5	1248	4010	2100	2
02055WR1037M65	3x50+2x25/2+12FO	57,5	1680	4550	3000	1
02055WR1037M66	3x70+2x35/2+12FO	60,5	2352	5500	4200	2/0
02055WR1037M67	3x95+2x50/2+12FO	66,5	3216	6940	5700	3/0
02055WR1037M68	3x120+2x70/2+12FO	67,5	4128	7560	7200	4/0
02055WR1037M69	3x150+2x70/2+12FO	71,5	4992	8710	9000	250 MCM
02055WR1037M70	3x185+2x95/2+12FO	75,5	6240	10250	11100	350 MCM
02055WR1037M71	3x240+2x120/2+12FO	82	8064	12600	14400	450 MCM

18/30 kV (36) kV

Part no.	No. of cores x cross section n x mm ²	Outer-Ø ca.mm ± 10%	Copper weight kg/km	Cable weight approx. kg/km	Tensile strenght N	AWG no.*)
02055XR1037M63	3x25+2x25/2+12FO	61,5	960	4700	1500	4
02055XR1037M64	3x35+2x25/2+12FO	61,5	1248	4800	2100	2
02055XR1037M65	3x50+2x25/2+12FO	63,5	1680	5300	3000	1
02055XR1037M66	3x70+2x35/2+12FO	66,5	2352	6300	4200	2/0
02055XR1037M67	3x95+2x50/2+12FO	69,5	3216	7300	5700	3/0
02055XR1037M68	3x120+2x70/2+12FO	72,5	4128	8320	7200	4/0
02055XR1037M69	3x150+2x70/2+12FO	77,5	4992	9600	9000	250 MCM
02055XR1037M70	3x185+2x95/2+12FO	82	6240	11200	11100	350 MCM
02055XR1037M71	3x240+2x120/2+12FO	87	8064	13510	14400	450 MCM

CABLE REELS

FLEXIDRUM® MEDIUM PLUS (N)TSCGEWÖU OPTICAL FIBER

From 3,6/6 Kv up to 18/30 Kv with antitwisting protection and optical fiber



ELETTROTEK KABEL® FLEXIDRUM® MEDIUM PLUS (N)TSCGEWÖU OPTICAL FIBER



Suitable for reeling application



Suitable for test application

Nominal cross section mm ²	Max resistance		Reactance at 50 Hz for nominal voltage			
	D.C. at 20°C Ohm/km	A.C. at 90°C Ohm/km	3,6/6 Ohm/km	6/10 Ohm/km	8,7/15 Ohm/km	12/20 Ohm/km
25	0,780	0,995	0,106	0,107	0,114	0,123
35	0,554	0,707	0,100	0,101	0,107	0,116
50	0,386	0,493	0,095	0,097	0,102	0,110
70	0,272	0,348	0,090	0,092	0,097	0,104
95	0,206	0,264	0,087	0,088	0,093	0,099
120	0,161	0,207	0,084	0,085	0,089	0,095
150	0,129	0,167	0,082	0,083	0,087	0,092
185	0,106	0,139	0,080	0,081	0,085	0,090
240	0,0801	0,107	0,079	0,079	0,083	0,087

Correction factors for ambient temperature other than 30°C

°C	10	20	30	40	50	60	70
K	1,15	1,08	1	0,91	0,82	0,71	0,58

Optical parameters:

Transmission data of the fiber-optics	Graded-index fiber 50/125	Graded-index fiber 62.5/125	Monomode fiber E9/125
Max attenuation at wavelength 850 nm	nom. ≤ 2,6 max. ≤ 3,0	nom. ≤ 2,6 max. ≤ 3,5	-
Max attenuation at wavelength 1300 nm	nom. ≤ 0,8 max. ≤ 1	nom. ≤ 0,8 max. ≤ 1,5	-
Max attenuation at wavelength 1310 nm	-	≤ 3 dB/km	nom. ≤ 0,35 max. ≤ 0,40
Max attenuation at wavelength 1383 nm	-	≤ 0,8 dB/km	nom. ≤ 0,33 max. ≤ 0,40
Max attenuation at wavelength 1550 nm	-	-	nom. ≤ 0,20 max. ≤ 0,28
Bandwidth at 850 nm	600 MHz/km	200 MHz/km	-
Bandwidth at 1300 nm	1200 MHz/km	500 MHz/km	-
Numerical aperture	0,20+/-0,015	0,27+/-0,015	-
Chromatic dispersion at 1285/1330 nm	-	-	≤ 3,5 ps/nm x km
Chromatic dispersion at 1300 nm	-	-	-
Chromatic dispersion at 1550 nm	-	-	≤ 18 ps/nm x km
Chromatic dispersion at 1625 nm	-	-	≤ 22 ps/nm x km

CABLE REELS

FLEXIDRUM® MEDIUM (N)TSCGEWÖU TUNNEL

From 3,6/6 Kv up to 12/20 Kv

ELETTROTEK KABEL® FLEXIDRUM® MEDIUM (N)TSCGEWÖU TUNNEL

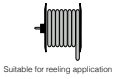

Construction:

Conductor:	flexible tinned copper conductor Cl. 5, acc. to IEC 60228, DIN VDE 0295
Inner semi-conductive layer:	semi-conducting compound
Insulation:	rubber EPR type 3GI3
Outer semi-conductive layer:	semi-conducting compound
Earth conductor:	tinned copper/textile braid combined laying concentric around each power cores
Cores color:	Power: natural color with black semi-conducting compound Control: black semi-conducting compound
Stranding:	phase units laid up with control conductors in interstices
Inner sheath:	rubber EPR type GM1b, acc. to DIN VDE 0207 part 21
monitoring conductor:	red copper wires, laying concentric between inner and outer sheath (6 ÜL KON)
Outer sheath:	red (similar to RAL 3000) rubber PCP type 5GM5

Resistance:



Self-extinguishing and flame retardant acc. to:
DIN VDE 0482 part 265-2-1
EN 50265-2-1
IEC 60332-1-2



Oil resistance acc. to:
DIN VDE 0473 part 811-2-1
IEC EN 60811-2-1

Technical data:

Nominal voltage:	U/oU 3,6/6 kV, U/oU 6/10 kV, U/oU 8,7/15 kV, U/oU 12/20 kV
Max. operating voltage A.C.:	U/oU 3,6/6 kV = 4,2/7,2 kV U/oU 6/10 kV = 6,9/12 kV U/oU 8,7/15 kV = 10,4/18 kV U/oU 12/20 kV = 13,9/24 kV
Max. operating voltage D.C.:	U/oU 3,6/6 kV = 5,4/10,8 kV U/oU 6/10 kV = 9/18 kV U/oU 8,7/15 kV = 13,5/27 kV U/oU 12/20 kV = 18/36 kV
Test voltage:	U/oU 3,6/6 kV = 11 kV U/oU 6/10 kV = 17 kV U/oU 8,7/15 kV = 24 kV U/oU 12/20 kV = 29 kV
Temperature range:	
<i>Fixed laying:</i>	-40°C up to +80°C
<i>Flexible installation:</i>	-20°C up to +80°C
Max. temperature on conductor:	+ 90°C
Max. temperature in short circuit:	+ 250 °C
Min. bending radius:	
<i>Fixed laying:</i>	6 x D
<i>On drums:</i>	12 x D
<i>On deflection pulley:</i>	15 x D
Min. distance for change of direction:	20 x D
Current carrying capacity:	acc. to DIN VDE 0298, part 4
Tensile strength:	up to 15 N/mm ²
Max speed (main application):	60 m/min
Max torsion:	± 25°/m

Features:

new version! for use in TBM's

outdoor/indoor use

ozone, moisture, water resistant

for SPEED and MINIMUM BENDING RADIUS see pages from 2 to 8 of catalogue

RoHS approval



Applications:

appropriate for reeling power supply cables mines in TBM'S machines and underground mines for tunnel construction applications

CABLE REELS

FLEXIDRUM® MEDIUM (N)TSCGEWÖU TUNNEL

From 3,6/6 Kv up to 12/20 Kv



3,6/6 kV (7,2) kV

Part no.	No. of cores x cross section n x mm ²	Outer-Ø ca.mm ± 10%	Cable weight approx. kg/km	Tensile strenght N	AWG no.*)
02060MR1037M63	3x25+3x16/3E +3x2,5ST + 6ÜL KON	41,7	2775	1125	4
02060MR1037M64	3x35+3x25/3E +3x2,5ST + 6ÜL KON	45,4	3205	1575	2
02060MR1037M65	3x50+3x25/3E +3x2,5ST + 6ÜL KON	49,9	4040	2250	1
02060MR1037M66	3x70+3x35/3E +3x2,5ST + 6ÜL KON	53,1	5030	3150	2/0
02060MR1037M67	3x95+3x50/3E +3x2,5ST + 6ÜL KON	59,1	6278	4275	3/0
02060MR1037M68	3x120+3x70/3E +3x2,5ST + 6ÜL KON	62,9	7365	5400	4/0

6/10 kV (12) kV

Part no.	No. of cores x cross section n x mm ²	Outer-Ø ca.mm ± 10%	Cable weight approx. kg/km	Tensile strenght N	AWG no.*)
02060QR1037M63	3x25+3x16/3E +3x2,5ST + 6ÜL KON	44,2	2975	1125	4
02060QR1037M64	3x35+3x25/3E +3x2,5ST + 6ÜL KON	46,7	3420	1575	2
02060QR1037M65	3x50+3x25/3E +3x2,5ST + 6ÜL KON	51,2	4257	2250	1
02060QR1037M66	3x70+3x35/3E +3x2,5ST + 6ÜL KON	56,1	5268	3150	2/0
02060QR1037M67	3x95+3x50/3E +3x2,5ST + 6ÜL KON	61,4	6538	4275	3/0
02060QR1037M68	3x120+3x70/3E +3x2,5ST + 6ÜL KON	65,1	7637	5400	4/0

CABLE REELS

FLEXIDRUM® MEDIUM (N)TSCGEWÖU TUNNEL

From 3,6/6 Kv up to 12/20 Kv



8,7/15 kV (18) kV

Part no.	No. of cores x cross section n x mm ²	Outer-Ø ca.mm ± 10%	Cable weight approx. kg/km	Tensile strenght N	AWG no.*)
02060SR1037M64	3x35+3x25/3E +3x2,5ST + 6ÜL KON	49,5	4017	1575	2

12/20 kV (24) kV

Part no.	No. of cores x cross section n x mm ²	Outer-Ø ca.mm ± 10%	Cable weight approx. kg/km	Tensile strenght N	AWG no.*)
02060UR1037M63	3x25+3x16/3E +3x2,5ST + 6ÜL KON	50,5	3527	1125	4
02060UR1037M64	3x35+3x25/3E +3x2,5ST + 6ÜL KON	53,3	4140	1575	2
02060UR1037M65	3x50+3x25/3E +3x2,5ST + 6ÜL KON	58,4	5060	2250	1
02060UR1037M66	3x70+3x35/3E +3x2,5ST + 6ÜL KON	62	6059	3150	2/0
02060UR1037M67	3x95+3x50/3E +3x2,5ST + 6ÜL KON	68,1	7512	4275	3/0
02060UR1037M68	3x120+3x70/3E +3x2,5ST + 6ÜL KON	71,9	8815	5400	4/0

Other dimensions and colors available on request.

CABLE REELS

FLEXIDRUM® MEDIUM R 903

From 3,6/6 Kv up to 12/20 Kv



Construction:

Conductor:	flexible red copper conductor Cl. 5, acc. to IEC 60228, DIN VDE 0295
Inner semi-conductive layer:	semi-conducting compound
Insulation:	rubber EPR compound type IEC 60502-2
Outer semi-conductive layer:	semi-conducting compound + red copper braid
Earth conductor:	flexible red copper conductor Cl. 5, acc. to IEC 60228, DIN VDE 0295
Earth semi-conductive layer:	semi-conducting compound
Cores color:	Power: natural color with black semi-conducting compound Earth: black semi-conducting compound
Central unit:	aramide yarns
Inner sheath:	halogen-free compound
monitoring conductor:	semi-conducting compound + red copper braid laying concentric between inner and outer sheath
Outer sheath:	red (similar to RAL 3000), special PUR compound

Technical data:

Nominal voltage:	U/oU 3,6/6 kV, U/oU 6/10 kV U/oU 12/20 kV
Max. operating voltage A.C.:	U/oU 3,6/6 kV = 4,2/7,2 kV U/oU 6/10 kV = 6,9/12 kV U/oU 12/20 kV = 13,9/24 kV
Max. operating voltage D.C.:	U/oU 3,6/6 kV = 5,4/10 kV U/oU 6/10 kV = 9/18 kV U/oU 12/20 kV = 18/36 kV
Test voltage (15 min.):	U/oU 3,6/6 kV = 13 kV U/oU 6/10 kV = 21 kV U/oU 12/20 kV = 42 kV
Temperature range:	
<i>Fixed laying:</i>	-40°C up to +80°C
<i>Flexible installation:</i>	-20°C up to +80°C
Max. temperature on conductor:	+ 90°C
Max. temperature in short circuit:	+ 250 °C
Min. bending radius:	
<i>Fixed laying:</i>	8 x d
<i>Flexible installation:</i>	
<i>6/10 kV:</i>	10 x D
<i>12/20 kV:</i>	12 x D
Current carrying capacity:	acc. to DIN VDE 0298, part 4
Tensile strength:	up to 20 N/mm ²
Max speed (main application):	60 m/min
Max torsion:	± 25°/m

Resistance:



Self-extinguishing and flame retardant acc. to:
DIN VDE 0482 part 265-2-1
EN 50265-2-1
IEC 60332-1-2



Oil resistance acc. to:
DIN VDE 0473 part 811-2-1
IEC EN 60811-2-1

Features:

new version! for use in TBM's

outdoor/indoor use

ozone, moisture, water resistant

for SPEED and MINIMUM BENDING RADIUS
see pages from 2 to 8 of catalogue

RoHS approval



Applications:

appropriate for reeling power supply cables
mines in TBM'S machines and underground
mines for tunnel construction applications

CABLE REELS

FLEXIDRUM® MEDIUM R 903

From 3,6/6 Kv up to 12/20 Kv



Suitable for reeling application

3,6/6 kV (7,2) kV

Part no.	No. of cores x cross section n x mm ²	Outer-Ø ca.mm ± 10%	Cable weight approx. kg/km	Tensile strenght N	AWG no.*)
02130MR1037M63	3x25+3x16/3E +3x2,5 + 6ÜL KON	40	2130	1500	4
02130MR1037M64	3x35+3x25/3E +3x2,5 + 6ÜL KON	43,5	2460	2100	2
02130MR1037M65	3x50+3x25/3E +3x2,5 + 6ÜL KON	47,5	3310	3000	1
02130MR1037M66	3x70+3x35/3E +3x2,5 + 6ÜL KON	51	4270	4200	2/0
02130MR1037M67	3x95+3x50/3E +3x2,5 + 6ÜL KON	57	5520	5700	3/0
02130MR1037M68	3x120+3x70/3E +3x2,5 + 6ÜL KON	61	6480	7200	4/0

6/10 kV (12) kV

Part no.	No. of cores x cross section n x mm ²	Outer-Ø ca.mm ± 10%	Cable weight approx. kg/km	Tensile strenght N	AWG no.*)
02130QR1037M63	3x25+3x16/3E +3x2,5 + 6ÜL KON	42,5	2800	1500	4
02130QR1037M64	3x35+3x25/3E +3x2,5 + 6ÜL KON	46	3400	2100	2
02130QR1037M65	3x50+3x25/3E +3x2,5 + 6ÜL KON	50,5	4000	3000	1
02130QR1037M66	3x70+3x35/3E +3x2,5 + 6ÜL KON	54	5050	4200	2/0
02130QR1037M67	3x95+3x50/3E +3x2,5 + 6ÜL KON	60,5	6350	5700	3/0
02130QR1037M68	3x120+3x70/3E +3x2,5 + 6ÜL KON	64	7600	7200	4/0

12/20 kV (24) kV

Part no.	No. of cores x cross section n x mm ²	Outer-Ø ca.mm ± 10%	Cable weight approx. kg/km	Tensile strenght N	AWG no.*)
02130UR1037M64	3x35+3x25/3E +3x2,5 + 6ÜL KON	52	3950	2100	2
02130UR1037M65	3x50+3x25/3E +3x2,5 + 6ÜL KON	55	4550	3000	1
02130UR1037M66	3x70+3x35/3E +3x2,5 + 6ÜL KON	59,5	5700	4200	2/0
02130UR1037M67	3x95+3x50/3E +3x2,5 + 6ÜL KON	66	7050	5700	3/0
02130UR1037M68	3x120+3x70/3E +3x2,5 + 6ÜL KON	69,5	8250	7200	4/0

Other dimensions and colors available on request.

CABLE REELS

FLEXIDRUM® MEDIUM (N)TSCGEWÖU WATER

From 1,8/3 Kv up to 18/30 Kv

ELETTROTEK KABEL® FLEXIDRUM® MEDIUM (N)TSCGECEWÖU WATER



Construction:

Conductor:	flexible tinned copper conductor Cl. 5, acc. to IEC 60228, DIN VDE 0295
Inner semi-conductive layer:	semi-conducting compound
Insulation:	rubber EPR compound type 3GI3
Outer semi-conductive layer:	semi-conducting compound
Earth conductor:	flexible tinned copper conductor Cl. 5, acc. to IEC 60228, DIN VDE 0295
Earth semi-conductive layer:	semi-conducting compound
Cores color:	Power: natural color with black semi-conducting compound Earth: black semi-conducting compound
Stranding:	phase units laid up with earth-conductors in interstices
Inner sheath:	rubber EPR type GM1b
Outer sheath:	red (similar to RAL 3000), special PCP type 5GM3

Resistance:



Self-extinguishing and flame retardant acc. to:
DIN VDE 0482 part 265-2-1
EN 50265-2-1
IEC 60332-1-2



Oil resistance acc. to:
DIN VDE 0473 part 811-2-1
IEC EN 60811-2-1



Water resistance acc. to:
HD 22.16

Technical data:

Nominal voltage:	U/oU 1,8/3 kV, U/oU 3,6/6 kV, U/oU 6/10 kV, U/oU 8,7/15 kV, U/oU 12/20 kV, U/oU 14/25 kV, U/oU 18/30 kV
Max. operating voltage A.C.:	U/oU 1,8/3 kV = 2,1/3,6 kV U/oU 3,6/6 kV = 4,7/7,2 kV U/oU 6/10 kV = 6,9/12 kV U/oU 8,7/15 kV = 10,4/18 kV U/oU 12/20 kV = 13,9/24 kV U/oU 14/25 kV = 17,3/30 kV U/oU 18/30 kV = 20,8/36 kV
Max. operating voltage D.C.:	U/oU 1,8/3 kV = 2,7/5,4 kV U/oU 3,6/6 kV = 5,4/10,8 kV U/oU 6/10 kV = 9/18 kV U/oU 8,7/15 kV = 13,5/27 kV U/oU 12/20 kV = 18/36 kV U/oU 14/25 kV = 22,5/45 kV U/oU 18/30 kV = 27/54 kV
Test voltage:	U/oU 1,8/3 kV = 6 kV U/oU 3,6/6 kV = 11 kV U/oU 6/10 kV = 17 kV U/oU 8,7/15 kV = 24 kV U/oU 12/20 kV = 29 kV U/oU 14/25 kV = 36 kV U/oU 18/30 kV = 43 kV
Temperature range:	
<i>Fixed laying:</i>	-40°C up to +80°C
<i>Flexible installation:</i>	-20°C up to +60°C
Max. temperature in water:	+ 40°C
Max. temperature on conductor:	+ 90°C
Max. temperature in short circuit:	+ 250 °C
Min. bending radius:	acc. to DIN VDE 0298, part 3
Tensile strength:	up to 15 N/mm ²
Max torsion:	± 100°/mm

Features:

for use in water!

outdoor/indoor use
UV, ozone, and moisture resistant
high-mechanical stresses
use in waste water, salt water and brackish water
cold version -45°C possible
GOST-R and others approvals on request

for MINIMUM BENDING RADIUS
see pages from 5 to 8 of catalogue

RoHS approval



Applications:

power supply cable for use in water:
connection to dredgers, pumps, ect.

CABLE REELS

FLEXIDRUM® MEDIUM (N)TSCGEWÖU WATER

From 1,8/3 Kv up to 18/30 Kv



1,8/3 kV

Part no.	No. of cores x cross section n x mm ²	Outer-Ø ca.mm ± 10%	Copper weight kg/km	Cable weight approx. kg/km	Tensile strenght N	AWG no.®)
02080KR1037M63	3x25+3x16/3	36,9	873,6	2180	1125	4
02080KR1037M64	3x35+3x16/3	39,5	1161,6	2610	1575	2
02080KR1037M65	3x50+3x25/3	43,8	1680	3330	2250	1
02080KR1037M66	3x70+3x35/3	49,1	2352	4370	3150	2/0
02080KR1037M67	3x95+3x50/3	55,3	3216	5660	4275	3/0
02080KR1037M68	3x120+3x70/3	58,6	4128	6725	5400	4/0
02080KR1037M69	3x150+3x70/3	62,6	4992	7820	6750	250 MCM
02080KR1037M70	3x185+3x95/3	68,2	6240	9435	8325	350 MCM

3,6/6 kV

Part no.	No. of cores x cross section n x mm ²	Outer-Ø ca.mm ± 10%	Copper weight kg/km	Cable weight approx. kg/km	Tensile strenght N	AWG no.®)
02080MR1037M63	3x25+3x16/3	41,8	873,6	2625	1125	4
02080MR1037M64	3x35+3x16/3	44,3	1161,6	3080	1575	2
02080MR1037M65	3x50+3x25/3	47,3	1680	3695	2250	1
02080MR1037M66	3x70+3x35/3	54,7	2352	4984	3150	2/0
02080MR1037M67	3x95+3x50/3	57,9	3216	5972	4275	3/0
02080MR1037M68	3x120+3x70/3	61,2	4128	7051	5400	4/0
02080MR1037M69	3x150+3x70/3	66,9	4992	8469	6750	250 MCM
02080MR1037M70	3x185+3x95/3	70,8	6240	9855	8325	350 MCM

6/10 kV

Part no.	No. of cores x cross section n x mm ²	Outer-Ø ca.mm ± 10%	Copper weight kg/km	Cable weight approx. kg/km	Tensile strenght N	AWG no.®)
02080QR1037M63	3x25+3x16/3	43,5	873,6	2780	1125	4
02080QR1037M64	3x35+3x16/3	46	1161,6	3225	1575	2
02080QR1037M65	3x50+3x25/3	48,9	1680	3842	2250	1
02080QR1037M66	3x70+3x35/3	56	2352	5166	3150	2/0
02080QR1037M67	3x95+3x50/3	59,6	3216	6199	4275	3/0
02080QR1037M68	3x120+3x70/3	62,9	4128	7280	5400	4/0
02080QR1037M69	3x150+3x70/3	68,8	4992	8675	6750	250 MCM
02080QR1037M70	3x185+3x95/3	72,5	6240	10100	8325	350 MCM

8,7/15 kV

Part no.	No. of cores x cross section n x mm ²	Outer-Ø ca.mm ± 10%	Copper weight kg/km	Cable weight approx. kg/km	Tensile strenght N	AWG no.®)
02080SR1037M63	3x25+3x16/3	48,1	873,6	3230	1125	4
02080SR1037M64	3x35+3x16/3	50,7	1161,6	3715	1575	2
02080SR1037M65	3x50+3x25/3	55,5	1680	4630	2250	1
02080SR1037M66	3x70+3x35/3	60,7	2352	5793	3150	2/0
02080SR1037M67	3x95+3x50/3	66,1	3216	7111	4275	3/0
02080SR1037M68	3x120+3x70/3	69,4	4128	8262	5400	4/0
02080SR1037M69	3x150+3x70/3	73,3	4992	9418	6750	250 MCM
02080SR1037M70	3x185+3x95/3	78,9	6240	11175	8325	350 MCM

CABLE REELS

FLEXIDRUM® MEDIUM (N)TSCGEWÖU WATER

From 1,8/3 Kv up to 18/30 Kv



12/20 kV

Part no.	No. of cores x cross section n x mm ²	Outer-Ø ca.mm ± 10%	Copper weight kg/km	Cable weight approx. kg/km	Tensile strenght N	AWG no.*)
02080UR1037M63	3x25+3x16/3	54,3	873,6	3970	1125	4
02080UR1037M64	3x35+3x16/3	56,7	1161,6	4470	1575	2
02080UR1037M65	3x50+3x25/3	59,6	1680	5185	2250	1
02080UR1037M66	3x70+3x35/3	66,8	2352	6645	3150	2/0
02080UR1037M67	3x95+3x50/3	70,4	3216	7750	4275	3/0
02080UR1037M68	3x120+3x70/3	73,6	4128	8920	5400	4/0
02080UR1037M69	3x150+3x70/3	79,2	4992	10510	6750	250 MCM
02080UR1037M70	3x185+3x95/3	82,9	6240	11975	8325	350 MCM

14/25 kV

Part no.	No. of cores x cross section n x mm ²	Outer-Ø ca.mm ± 10%	Copper weight kg/km	Cable weight approx. kg/km	Tensile strenght N	AWG no.*)
02080WR1037M63	3x25+3x16/3	59,5	873,6	4680	1125	4
02080WR1037M64	3x35+3x16/3	62,4	1161,6	5235	1575	2
02080WR1037M65	3x50+3x25/3	67	1680	6215	2250	1
02080WR1037M66	3x70+3x35/3	72,3	2352	7515	3150	2/0
02080WR1037M67	3x95+3x50/3	77,7	3216	8990	4275	3/0
02080WR1037M68	3x120+3x70/3	80,8	4128	10215	5400	4/0
02080WR1037M69	3x150+3x70/3	84,8	4992	11505	6750	250 MCM
02080WR1037M70	3x185+3x95/3	90,5	6240	13427	8325	350 MCM

18/30 kV

Part no.	No. of cores x cross section n x mm ²	Outer-Ø ca.mm ± 10%	Copper weight kg/km	Cable weight approx. kg/km	Tensile strenght N	AWG no.*)
02080XR1037M63	3x25+3x16/3	66,4	873,6	5638	1125	4
02080XR1037M64	3x35+3x16/3	70,1	1161,6	6241	1575	2
02080XR1037M65	3x50+3x25/3	72,1	1680	7045	2250	1
02080XR1037M66	3x70+3x35/3	80	2352	8722	3150	2/0
02080XR1037M67	3x95+3x50/3	82,8	3216	9917	4275	3/0
02080XR1037M68	3x120+3x70/3	85,9	4128	11189	5400	4/0
02080XR1037M69	3x150+3x70/3	91,7	4992	12902	6750	250 MCM
02080XR1037M70	3x185+3x95/3	95,4	6240	14470	8325	350 MCM

Other dimensions and colors available on request.

CABLE REELS

FLEXIDRUM® MEDIUM (N)TSCGEWÖU WATER.../3E

From 1,8/3 Kv up to 18/30 Kv, with core copper screen

ELETTROTEK KABEL® FLEXIDRUM® MEDIUM (N)TSCGECEWÖU WATER 3E



Construction:

Conductor:	flexible tinned copper conductor Cl. 5, acc. to IEC 60228, DIN VDE 0295
Inner semi-conductive layer:	semi-conducting compound
Insulation:	rubber EPR compound type 3GI3
Outer semi-conductive layer:	semi-conducting compound
Cores color:	natural color with black semi-conducting compound
Earth conductor:	tinned copper wires laying concentric around each power cores
Inner sheath:	rubber EPR type GM1b
Outer sheath:	red (similar to RAL 3000), special PCP type 5GM3

Resistance:



Self-extinguishing and flame retardant acc. to:
DIN VDE 0482 part 265-2-1
EN 50265-2-1
IEC 60332-1-2



Oil resistance acc. to:
DIN VDE 0473 part 811-2-1
IEC EN 60811-2-1



Water resistance acc. to:
HD 22.16

Technical data:

Nominal voltage:	U/oU 1,8/3 kV, U/oU 3,6/6 kV, U/oU 6/10 kV, U/oU 8,7/15 kV, U/oU 12/20 kV, U/oU 14/25 kV, U/oU 18/30 kV
Max. operating voltage A.C.:	U/oU 1,8/3 kV = 2,1/3,6 kV U/oU 3,6/6 kV = 4,7/7,2 kV U/oU 6/10 kV = 6,9/12 kV U/oU 8,7/15 kV = 10,4/18 kV U/oU 12/20 kV = 13,9/24 kV U/oU 14/25 kV = 17,3/30 kV U/oU 18/30 kV = 20,8/36 kV
Max. operating voltage D.C.:	U/oU 1,8/3 kV = 2,7/5,4 kV U/oU 3,6/6 kV = 5,4/10,8 kV U/oU 6/10 kV = 9/18 kV U/oU 8,7/15 kV = 13,5/27 kV U/oU 12/20 kV = 18/36 kV U/oU 14/25 kV = 22,5/45 kV U/oU 18/30 kV = 27/54 kV
Test voltage:	U/oU 1,8/3 kV = 6 kV U/oU 3,6/6 kV = 11 kV U/oU 6/10 kV = 17 kV U/oU 8,7/15 kV = 24 kV U/oU 12/20 kV = 29 kV U/oU 14/25 kV = 36 kV U/oU 18/30 kV = 43 kV
Temperature range:	
<i>Fixed laying:</i>	-40°C up to +80°C
<i>Flexible installation:</i>	-20°C up to +60°C
Max. temperature in water:	+ 40°C
Max. temperature on conductor:	+ 90°C
Max. temperature in short circuit:	+ 250 °C
Min. bending radius:	acc. to DIN VDE 0298, part 3
Tensile strenght:	up to 15 N/mm ²
Max torsion:	± 25°/mm

Features:

for use in water!

outdoor/indoor use
UV, ozone, and moisture resistant
high-mechanical stresses
use in waste water, salt water and brackish water
cold version -45°C possible
GOST-R and others approvals on request
for MINIMUM BENDING RADIUS
see pages from 5 to 8 of catalogue
RoHS approval



Applications:

power supply cable for use in water:
connection to dredgers, pumps, ect.

CABLE REELS

FLEXIDRUM® MEDIUM (N)TSCGEWÖU WATER.../3E

From 1,8/3 Kv up to 18/30 Kv, with core copper screen



1,8/3 kV

Part no.	No. of cores x cross section n x mm ²	Outer-Ø ca.mm ± 10%	Copper weight kg/km	Cable weight approx. kg/km	Tensile strenght N	AWG no.*)
02070KR1037M63	3x25+3x16/3E	39,5	873,6	2440	1125	4
02070KR1037M64	3x35+3x16/3E	43,4	1161,6	3020	1575	2
02070KR1037M65	3x50+3x25/3E	49,1	1680	3615	2250	1
02070KR1037M66	3x70+3x35/3E	53,5	2352	4910	3150	2/0
02070KR1037M67	3x95+3x50/3E	58,4	3216	6114	4275	3/0
02070KR1037M68	3x120+3x70/3E	61,9	4128	7305	5400	4/0
02070KR1037M69	3x150+3x70/3E	67,7	4992	8698	6750	250 MCM
02070KR1037M70	3x185+3x95/3E	71,5	6240	10167	8325	350 MCM

3,6/6 kV

Part no.	No. of cores x cross section n x mm ²	Outer-Ø ca.mm ± 10%	Copper weight kg/km	Cable weight approx. kg/km	Tensile strenght N	AWG no.*)
02070MR1037M63	3x25+3x16/3E	44,5	873,6	2920	1125	4
02070MR1037M64	3x35+3x16/3E	47,3	1161,6	3345	1575	2
02070MR1037M65	3x50+3x25/3E	51,1	1680,0	3998	2250	1
02070MR1037M66	3x70+3x35/3E	57,1	2352,0	5339	3150	2/0
02070MR1037M67	3x95+3x50/3E	61,2	3216,0	6460	4275	3/0
02070MR1037M68	3x120+3x70/3E	66,5	4128,0	8150	5400	4/0
02070MR1037M69	3x150+3x70/3E	70,6	4992,0	9020	6750	250 MCM
02070MR1037M70	3x185+3x95/3E	74,3	6240,0	10575	8325	350 MCM

6/10 kV

Part no.	No. of cores x cross section n x mm ²	Outer-Ø ca.mm ± 10%	Copper weight kg/km	Cable weight approx. kg/km	Tensile strenght N	AWG no.*)
02070QR1037M63	3x25+3x16/3E	45,6	873,6	3055	1125	4
02070QR1037M64	3x35+3x16/3E	48,3	1161,6	3530	1575	2
02070QR1037M65	3x50+3x25/3E	53,3	1680,0	4377	2250	1
02070QR1037M66	3x70+3x35/3E	58,7	2352,0	5543	3150	2/0
02070QR1037M67	3x95+3x50/3E	62,6	3216,0	6672	4275	3/0
02070QR1037M68	3x120+3x70/3E	68,1	4128,0	8170	5400	4/0
02070QR1037M69	3x150+3x70/3E	72,0	4992,0	9340	6750	250 MCM
02070QR1037M70	3x185+3x95/3E	77,6	6240,0	11145	8325	350 MCM

8,7/15 kV

Part no.	No. of cores x cross section n x mm ²	Outer-Ø ca.mm ± 10%	Copper weight kg/km	Cable weight approx. kg/km	Tensile strenght N	AWG no.*)
02070SR1037M63	3x25+3x16/3E	50,6	873,6	3570	1125	4
02070SR1037M64	3x35+3x16/3E	55,0	1161,6	4270	1575	2
02070SR1037M65	3x50+3x25/3E	57,9	1680,0	4930	2250	1
02070SR1037M66	3x70+3x35/3E	65,1	2352,0	6430	3150	2/0
02070SR1037M67	3x95+3x50/3E	68,9	3216,0	7620	4275	3/0
02070SR1037M68	3x120+3x70/3E	72,6	4128,0	8890	5400	4/0
02070SR1037M69	3x150+3x70/3E	78,5	4992,0	10420	6750	250 MCM
02070SR1037M70	3x185+3x95/3E	82,3	6240,0	11990	8325	350 MCM

CABLE REELS

FLEXIDRUM® MEDIUM (N)TSCGEWÖU WATER.../3E

From 1,8/3 Kv up to 18/30 Kv, with core copper screen

ELETTROTEK KABEL® FLEXIDRUM® MEDIUM (N)TSCGECEWÖU WATER 3E



12/20 kV

Part no.	No. of cores x cross section n x mm ²	Outer-Ø ca.mm ± 10%	Copper weight kg/km	Cable weight approx. kg/km	Tensile strenght N	AWG no.®)
02070UR1037M63	3x25+3x16/3E	56,6	873,6	4290	1125	4
02070UR1037M64	3x35+3x16/3E	59,2	1161,6	4800	1575	2
02070UR1037M65	3x50+3x25/3E	62,1	1680	5530	2250	1
02070UR1037M66	3x70+3x35/3E	69,3	2352	7105	3150	2/0
02070UR1037M67	3x95+3x50/3E	73,4	3216	8290	4275	3/0
02070UR1037M68	3x120+3x70/3E	78,6	4128	9920	5400	4/0
02070UR1037M69	3x150+3x70/3E	82,7	4992	11187	6750	250 MCM
02070UR1037M70	3x185+3x95/3E	86,5	6240	12770	8325	350 MCM

14/25 kV

Part no.	No. of cores x cross section n x mm ²	Outer-Ø ca.mm ± 10%	Copper weight kg/km	Cable weight approx. kg/km	Tensile strenght N	AWG no.®)
02070WR1037M63	3x25+3x16/3E	62,3	873,6	5030	1125	4
02070WR1037M64	3x35+3x16/3E	66,4	1161,6	5828	1575	2
02070WR1037M65	3x50+3x25/3E	69,5	1680	6612	2250	1
02070WR1037M66	3x70+3x35/3E	74,8	2352	7978	3150	2/0
02070WR1037M67	3x95+3x50/3E	80,6	3216	9550	4275	3/0
02070WR1037M68	3x120+3x70/3E	84,1	4128	10925	5400	4/0
02070WR1037M69	3x150+3x70/3E	89,8	4992	12578	6750	250 MCM
02070WR1037M70	3x185+3x95/3E	93,9	6240	14275	8325	350 MCM

18/30 kV

Part no.	No. of cores x cross section n x mm ²	Outer-Ø ca.mm ± 10%	Copper weight kg/km	Cable weight approx. kg/km	Tensile strenght N	AWG no.®)
02070XR1037M63	3x25+3x16/3E	69	873,6	6045	1125	4
02070XR1037M64	3x35+3x16/3E	71,5	1161,6	6610	1575	2
02070XR1037M65	3x50+3x25/3E	74,6	1680	7418	2250	1
02070XR1037M66	3x70+3x35/3E	81,7	2352	9189	3150	2/0
02070XR1037M67	3x95+3x50/3E	85,5	3216	10505	4275	3/0
02070XR1037M68	3x120+3x70/3E	91,2	4128	12280	5400	4/0
02070XR1037M69	3x150+3x70/3E	94,6	4992	13638	6750	250 MCM
02070XR1037M70	3x185+3x95/3E	100,8	6240	15780	8325	350 MCM

Other dimensions and colors available on request.

CABLE REELS

FLEXIDRUM® MEDIUM RS (N)TSCGEWÖU

From 3,6/6 Kv up to 12/20 Kv, on request 14/25 kV

ELETTROTEK KABEL® FLEXIDRUM® RS (N)TSCGEWÖU



Suitable for reeling application



Suitable for festoon application

Construction:

Conductor:	flexible red copper conductor Cl. 5, acc. to IEC 60228, DIN VDE 0295
Inner semi-conductive layer:	semi-conducting compound
Insulation:	rubber EPR compound type 3GI3
Outer semi-conductive layer:	semi-conducting compound
Earth conductor:	flexible red copper conductor Cl. 5, acc. to IEC 60228, DIN VDE 0295
Earth semi-conductive layer:	semi-conducting compound
Cores color:	Power: natural color with black semi-conducting compound Earth: black semi-conducting compound
Stranding:	phase units laid up with earth-conductors in interstices
Inner sheath:	rubber PCP compound
Outer sheath:	red (similar to RAL 3000), special PCP compound

Technical data:

Nominal voltage:	U/oU 3,6/6 kV, U/oU 6/10 kV, U/oU 8,7/15 kV, U/oU 12/20 kV On request 14/25 kV
Max. operating voltage.:	U/oU 3,6/6 kV = 5,4 kV U/oU 6/10 kV = 12 kV U/oU 8,7/15 kV = 18 kV U/oU 12/20 kV = 24 kV U/oU 14/25 kV = 30 kV
Test voltage:	U/oU 3,6/6 kV = 11 kV U/oU 6/10 kV = 17 kV U/oU 8,7/15 kV = 24 kV U/oU 12/20 kV = 29 kV U/oU 14/25 kV = 36 kV
Temperature range:	
<i>Fixed laying:</i>	-40°C up to +80°C
<i>Flexible installation:</i>	-30°C up to +80°C
Max. temperature on conductor:	+ 90°C
Max. temperature in short circuit:	+ 250 °C
Min. bending radius:	
<i>Fixed laying:</i>	6 x D
<i>On drums:</i>	12 x D
<i>On deflection pulleys:</i>	15 x D
<i>Free movement:</i>	12 x D
<i>Min. distance for change of direction:</i>	20 x D
Current carrying capacity:	acc. to DIN VDE 0298-4
Tensile strength:	20 N/mm ²
Max speed (main application):	60 m/min

Resistance:



Self-extinguishing and flame retardant acc. to:
DIN VDE 0482 part 265-2-1
EN 50265-2-1
IEC 60332-1-2



Oil resistance acc. to:
DIN VDE 0473 part 811-2-1
IEC EN 60811-2-1



Water resistance acc. to:
HD 22.16

Features:

mining excavator!

outdoor/indoor use
UV, ozone, and moisture resistant
double layer
small outer diameter and light weight
possible version with antitwisting protection
possible version with tinned Cu-conductors
cold version -45°C possible
GOST-R WUG and others approvals on request
for SPEED and MINIMUM BENDING RADIUS see pages from 2 to 8 of catalogue

RoHS approval



Applications:

power supply cable for use in water:
connection to dredgers, pumps, ect.

suitable for application where it is deflected in one level only, because it's without anti-twisting protection.

CABLE REELS

FLEXIDRUM® MEDIUM RS (N)TSCGEWÖU

From 3,6/6 Kv up to 12/20 Kv, on request 14/25 kV



Suitable for reeling application



Suitable for festoon application

Uo/U (Um) 3,6/6 (7,2) kV

Part no.	No. of cores x cross section n x mm ²	Outer-Ø ca.mm ± 10%	Copper weight kg/km	Cable weight approx. kg/km	Tensile strenght N	AWG no.®)
02090MR1037M63	3x25+3x25/3	40,3	960	2410	1500	4
02090MR1037M64	3x35+3x25/3	43	1248	2935	2100	2
02090MR1037M65	3x50+3x25/3	45,8	1680	3455	3000	1
02090MR1037M66	3x70+3x35/3	49,8	2352	4360	4200	2/0
02090MR1037M67	3x95+3x50/3	53,7	3216	5365	5700	3/0
02090MR1037M68	3x120+3x70/3	58	4128	6746	7200	4/0
02090MR1037M69	3x150+3x70/3	62,5	4992	7743	9000	250 MCM
02090MR1037M70	3x185+3x95/3	65,6	6240	9169	11100	350 MCM
02090MR1037M71	3x240+3x120/3	74	8064	11980	14400	450 MCM

Uo/U (Um) 6/10 (12) kV

Part no.	No. of cores x cross section n x mm ²	Outer-Ø ca.mm ± 10%	Copper weight kg/km	Cable weight approx. kg/km	Tensile strenght N	AWG no.®)
02090QR1037M63	3x25+3x25/3	42	960	2560	1500	4
02090QR1037M64	3x35+3x25/3	44,8	1248	3111	2100	2
02090QR1037M65	3x50+3x25/3	47,6	1680	3648	3000	1
02090QR1037M66	3x70+3x35/3	51,7	2352	4566	4200	2/0
02090QR1037M67	3x95+3x50/3	55,5	3216	5558	5700	3/0
02090QR1037M68	3x120+3x70/3	59,8	4128	6950	7200	4/0
02090QR1037M69	3x150+3x70/3	64,2	4992	7972	9000	250 MCM
02090QR1037M70	3x185+3x95/3	67,4	6240	9425	11100	350 MCM
02090QR1037M71	3x240+3x120/3	75,2	8064	12175	14400	450 MCM

Uo/U (Um) 8,7/15 (18) kV

Part no.	No. of cores x cross section n x mm ²	Outer-Ø ca.mm ± 10%	Copper weight kg/km	Cable weight approx. kg/km	Tensile strenght N	AWG no.®)
02090SR1037M63	3x25+3x25/3	45,5	960	2880	1500	4
02090SR1037M64	3x35+3x25/3	48,1	1248	3326	2100	2
02090SR1037M65	3x50+3x25/3	50,9	1680	3400	3000	1
02090SR1037M66	3x70+3x35/3	55,1	2352	4935	4200	2/0
02090SR1037M67	3x95+3x50/3	60,2	3216	5970	5700	3/0
02090SR1037M68	3x120+3x70/3	63,7	4128	7430	7200	4/0
02090SR1037M69	3x150+3x70/3	67,8	4992	8444	9000	250 MCM
02090SR1037M70	3x185+3x95/3	72,2	6240	10165	11100	350 MCM
02090SR1037M71	3x240+3x120/3	77,8	8064	12595	14400	450 MCM

Uo/U (Um) 12/20 (24) kV

Part no.	No. of cores x cross section n x mm ²	Outer-Ø ca.mm ± 10%	Copper weight kg/km	Cable weight approx. kg/km	Tensile strenght N	AWG no.®)
02090UR1037M63	3x25+3x25/3	50,2	960	3360	1500	4
02090UR1037M64	3x35+3x25/3	53	1248	3946	2100	2
02090UR1037M65	3x50+3x25/3	55,8	1680	4533	3000	1
02090UR1037M66	3x70+3x35/3	59,8	2352	5515	4200	2/0
02090UR1037M67	3x95+3x50/3	64,1	3216	6639	5700	3/0
02090UR1037M68	3x120+3x70/3	68,4	4128	8098	7200	4/0
02090UR1037M69	3x150+3x70/3	73,9	4992	9375	9000	250 MCM
02090UR1037M70	3x185+3x95/3	76,9	6240	10865	11100	350 MCM
02090UR1037M71	3x240+3x120/3	-	8064	13550	14400	450 MCM

Other dimensions and colors available on request.

CABLE REELS

FLEXIDRUM® MEDIUM RS (N)TSCGEWÖU

From 3,6/6 Kv up to 12/20 Kv, on request 14/25 kV



Suitable for reeling application



Suitable for festoon application

Nominal cross section mm ²	Max resistance		Reactance at 50 Hz for nominal voltage			
	D.C. at 20°C Ohm/km	A.C. at 90°C Ohm/km	3,6/6 Ohm/km	6/10 Ohm/km	8,7/15 Ohm/km	12/20 Ohm/km
25	0,780	0,995	0,107	0,111	0,117	0,125
35	0,554	0,707	0,075	0,104	0,110	0,117
50	0,386	0,493	0,075	0,100	0,105	0,112
70	0,272	0,348	0,073	0,094	0,099	0,106
95	0,206	0,264	0,072	0,091	0,095	0,101
120	0,161	0,207	0,071	0,087	0,091	0,097
150	0,129	0,167	0,071	0,085	0,088	0,093
185	0,106	0,139	0,072	0,083	0,087	0,091
240	0,0801	0,107	0,072	0,082	0,084	0,089

Correction factors for ambient temperature other than 30°C

°C	20	25	30	40	45	50	55
K	1,1	1,05	0,95	0,89	0,84	0,77	0,71

CABLE REELS

FLEXIDRUM® MEDIUM RS (N)TSCGEWÖU

From 3,6/6 Kv up to 14/25 Kv, with antitwisting protection

ELETTROTEK KABEL® FLEXIDRUM® MEDIUM RS (N)TSCGEWÖU

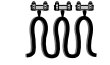

Construction:

Conductor:	flexible red copper conductor Cl. 5, acc. to IEC 60228, DIN VDE 0295
Inner semi-conductive layer:	semi-conducting compound
Insulation:	rubber EPR compound type 3GI3
Outer semi-conductive layer:	semi-conducting compound
Earth conductor:	flexible red copper conductor Cl. 5, acc. to IEC 60228, DIN VDE 0295
Earth semi-conductive layer:	semi-conducting compound
Cores color:	Power: natural color with black semi-conducting compound Earth: black semi-conducting compound
Stranding:	phase units laid up with earth-conductors in interstices
Inner sheath:	rubber PCP compound
Supporting screen:	anti-twisting protection of synthetic yarns
Outer sheath:	red (similar to RAL 3000), special PCP compound

Technical data:

Nominal voltage:	U/oU 3,6/6 kV, U/oU 6/10 kV, U/oU 8,7/15 kV, U/oU 12/20 kV, U/oU 14/25 kV
Max. operating voltage.:	U/oU 3,6/6 kV = 5,4 kV U/oU 6/10 kV = 12 kV U/oU 8,7/15 kV = 18 kV U/oU 12/20 kV = 24 kV U/oU 14/25 kV = 30 kV
Test voltage:	U/oU 3,6/6 kV = 11 kV U/oU 6/10 kV = 17 kV U/oU 8,7/15 kV = 24 kV U/oU 12/20 kV = 29 kV U/oU 14/25 kV = 36 kV
Temperature range:	
<i>Fixed laying:</i>	-40°C up to +80°C
<i>Flexible installation:</i>	-30°C up to +80°C
Max. temperature on conductor:	+ 90°C
Max. temperature in short circuit:	+ 250 °C
Min. bending radius:	
<i>Fixed laying:</i>	6 x D
<i>On drums:</i>	12 x D
<i>On deflection pulleys:</i>	15 x D
<i>Free movement:</i>	12 x D
<i>Min. distance for change of direction:</i>	20 x D
Current carrying capacity:	acc. to DIN VDE 0298-4
Tensile strength:	20 N/mm ²
Max speed (main application):	180 m/min
Max. torsion:	+/- 25°/m

Resistance:



Self-extinguishing and flame retardant acc. to:
DIN VDE 0482 part 265-2-1
EN 50265-2-1
IEC 60332-1-2



Oil resistance acc. to:
DIN VDE 0473 part 811-2-1
IEC EN 60811-2-1



Water resistance acc. to:
HD 22.16

Features:

mining excavator!

outdoor/indoor use

UV, ozone, and moisture resistant

double layer with-antitwisting reinforcement

small outer diameter and light weight

possible version without antitwisting protection

possible version with tinned Cu-conductors

cold version -45°C possible

GOST-R WUG and others approvals on request

for SPEED and MINIMUM BENDING RADIUS see pages from 2 to 8 of catalogue

RoHS approval



Applications:

power supply cable for use in water:
connection to dredgers, pumps, ect.

suitable to operate with forced guidance systems with deflection on different levels and with reel axis in direction of travel.

CABLE REELS

FLEXIDRUM® MEDIUM RS (N)TSCGEWÖU

From 3,6/6 Kv up to 14/25 Kv, with antitwisting protection



Suitable for reeling application



Suitable for testson application

U_o/U (Um) 3,6/6 (7,2) kV

Part no.	No. of cores x cross section n x mm ²	Outer-Ø ca.mm ± 10%	Copper weight kg/km	Cable weight approx. kg/km	Tensile strenght N	AWG no.*)
02091MR1037M63	3x25+3x25/3	41,2	960	2535	1500	4
02091MR1037M64	3x35+3x25/3	43,7	1248	3025	2100	2
02091MR1037M65	3x50+3x25/3	46,6	1680	3560	3000	1
02091MR1037M66	3x70+3x35/3	50,7	2352	4480	4200	2/0
02091MR1037M67	3x95+3x50/3	54,7	3216	5478	5700	3/0
02091MR1037M68	3x120+3x70/3	58,9	4128	6875	7200	4/0
02091MR1037M69	3x150+3x70/3	63,4	4992	7920	9000	250 MCM
02091MR1037M70	3x185+3x95/3	66,5	6240	9335	11100	350 MCM
02091MR1037M71	3x240+3x120/3	74,8	8064	12140	14400	450 MCM

U_o/U (Um) 6/10 (12) kV

Part no.	No. of cores x cross section n x mm ²	Outer-Ø ca.mm ± 10%	Copper weight kg/km	Cable weight approx. kg/km	Tensile strenght N	AWG no.*)
02091QR1037M63	3x25+3x25/3	42,8	960	2667	1500	4
02091QR1037M64	3x35+3x25/3	45,6	1248	3215	2100	2
02091QR1037M65	3x50+3x25/3	51,4	1680	3733	3000	1
02091QR1037M66	3x70+3x35/3	52,5	2352	4682	4200	2/0
02091QR1037M67	3x95+3x50/3	56,3	3216	5701	5700	3/0
02091QR1037M68	3x120+3x70/3	60,3	4128	7105	7200	4/0
02091QR1037M69	3x150+3x70/3	65,1	4992	8128	9000	250 MCM
02091QR1037M70	3x185+3x95/3	68,1	6240	9578	11100	350 MCM
02091QR1037M71	3x240+3x120/3	75,9	8064	12365	14400	450 MCM

U_o/U (Um) 8,7/15 (18) kV

Part no.	No. of cores x cross section n x mm ²	Outer-Ø ca.mm ± 10%	Copper weight kg/km	Cable weight approx. kg/km	Tensile strenght N	AWG no.*)
02091SR1037M63	3x25+3x25/3	46,2	960	2987	1500	4
02091SR1037M64	3x35+3x25/3	48,9	1248	3530	2100	2
02091SR1037M65	3x50+3x25/3	51,7	1680	4121	3000	1
02091SR1037M66	3x70+3x35/3	55,8	2352	5080	4200	2/0
02091SR1037M67	3x95+3x50/3	59,7	3216	6146	5700	3/0
02091SR1037M68	3x120+3x70/3	64,7	4128	7590	7200	4/0
02091SR1037M69	3x150+3x70/3	68,5	4992	8605	9000	250 MCM
02091SR1037M70	3x185+3x95/3	72,9	6240	10305	11100	350 MCM
02091SR1037M71	3x240+3x120/3	78,6	8064	12730	14400	450 MCM

CABLE REELS

FLEXIDRUM® MEDIUM RS (N)TSCGEWÖU

From 3,6/6 Kv up to 14/25 Kv, with antitwisting protection

ELETTROTEK KABEL® FLEXIDRUM® MEDIUM RS (N)TSCGEWÖU



Suitable for reeling application



Suitable for festoon application

U₀/U (Um) 12/20 (24) kV

Part no.	No. of cores x cross section n x mm ²	Outer-Ø ca.mm ± 10%	Copper weight kg/km	Cable weight approx. kg/km	Tensile strength N	AWG no.®)
02091UR1037M63	3x25+3x25/3	50,7	960	3465	1500	4
02091UR1037M64	3x35+3x25/3	53,7	1248	4055	2100	2
02091UR1037M65	3x50+3x25/3	56,6	1680	4670	3000	1
02091UR1037M66	3x70+3x35/3	60,6	2352	5685	4200	2/0
02091UR1037M67	3x95+3x50/3	64,9	3216	6804	5700	3/0
02091UR1037M68	3x120+3x70/3	69,2	4128	8268	7200	4/0
02091UR1037M69	3x150+3x70/3	74,5	4992	9573	9000	250 MCM
02091UR1037M70	3x185+3x95/3	78,1	6240	11060	11100	350 MCM
02091UR1037M71	3x240+3x120/3	-	8064	13215	14400	450 MCM

U₀/U (Um) 14/25 (30) kV

Part no.	No. of cores x cross section n x mm ²	Outer-Ø ca.mm ± 10%	Copper weight kg/km	Cable weight approx. kg/km	Tensile strength N	AWG no.®)
02091WR1037M63	3x25+3x25/3	51,6	960	3375	1500	4
02091WR1037M64	3x35+3x25/3	55,7	1248	4038	2100	2
02091WR1037M65	3x50+3x25/3	59,4	1680	4810	3000	1
02091WR1037M66	3x70+3x35/3	63	2352	5838	4200	2/0
02091WR1037M67	3x95+3x50/3	68,6	3216	7290	5700	3/0
02091WR1037M68	3x120+3x70/3	72,3	4128	8510	7200	4/0
02091WR1037M69	3x150+3x70/3	77,7	4992	10075	9000	250 MCM
02091WR1037M70	3x185+3x95/3	81,5	6240	11620	11100	350 MCM
02091WR1037M71	3x240+3x120/3	89,4	8064	14675	14400	450 MCM

Other dimensions and colors available on request.

Nominal cross section mm ²	Max resistance		Reactance at 50 Hz for nominal voltage			
	D.C. at 20°C Ohm/km	A.C. at 90°C Ohm/km	3,6/6 Ohm/km	6/10 Ohm/km	8,7/15 Ohm/km	12/20 Ohm/km
25	0,780	0,995	0,107	0,111	0,117	0,125
35	0,554	0,707	0,075	0,104	0,110	0,117
50	0,386	0,493	0,075	0,100	0,105	0,112
70	0,272	0,348	0,073	0,094	0,099	0,106
95	0,206	0,264	0,072	0,091	0,095	0,101
120	0,161	0,207	0,071	0,087	0,091	0,097
150	0,129	0,167	0,071	0,085	0,088	0,093
185	0,106	0,139	0,072	0,083	0,087	0,091
240	0,0801	0,107	0,072	0,082	0,084	0,089

Correction factors for ambient temperature other than 30°C

°C	20	25	30	40	45	50	55
K	1,1	1,05	0,95	0,89	0,84	0,77	0,71

CABLE REELS

FLEXIDRUM® MEDIUM RS-T (N)TSCGEWÖU

From 1,8/3 Kv up to 18/30 Kv, with antitwisting protection

ELETTROTEK KABEL® FLEXIDRUM® MEDIUM RS-T (N)TSCGEWÖU

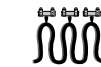

Suitable for reeling application

Suitable for festoon application

Construction:

Conductor:	flexible tinned copper conductor Cl. 5, acc. to IEC 60228, DIN VDE 0295
Inner semi-conductive layer:	semi-conducting compound
Insulation:	rubber EPR compound type 3GI3
Outer semi-conductive layer:	semi-conducting compound
Earth conductor:	flexible tinned copper conductor Cl. 5, acc. to IEC 60228, DIN VDE 0295
Earth semi-conductive layer:	semi-conducting compound
Cores color:	Power: natural color with black semi-conducting compound Earth: black semi-conducting compound
Wrapping:	tear-resistant tape
Inner sheath:	rubber PCP type 5GM5
Supporting screen:	anti-twisting protection of synthetic yarns
Outer sheath:	black (similar to RAL 9005), special PCP type 5GM5

Resistance:



Self-extinguishing and flame retardant acc. to:
DIN VDE 0482 part 265-2-1
EN 50265-2-1
IEC 60332-1-2



Oil resistance acc. to:
DIN VDE 0473 part 811-2-1
IEC EN 60811-2-1

Technical data:

Nominal voltage:	U/oU 1,8/3 kV, U/oU 3,6/6 kV, U/oU 6/10 kV, U/oU 8,7/15 kV, U/oU 12/20 kV, U/oU 18/30 kV
Max. operating voltage in A.C.:	U/oU 1,8/3 kV = 2,1/3,6 kV U/oU 3,6/6 kV = 4,2/7,2 kV U/oU 6/10 kV = 6,9/12 kV U/oU 8,7/15 kV = 10,4/18 kV U/oU 12/20 kV = 13,9/24 kV U/oU 18/30 kV = 20,8/36 kV
Max. operating voltage in D.C.:	U/oU 1,8/3 kV = 2,7/5,4 kV U/oU 3,6/6 kV = 5,4/10 kV U/oU 6/10 kV = 9/18 kV U/oU 8,7/15 kV = 13,5/27 kV U/oU 12/20 kV = 18/36 kV U/oU 18/30 kV = 27/54 kV
Test voltage:	U/oU 3,6/6 kV = 6 kV U/oU 3,6/6 kV = 11 kV U/oU 6/10 kV = 17 kV U/oU 8,7/15 kV = 24 kV U/oU 12/20 kV = 29 kV U/oU 18/30 kV = 43 kV
Temperature range:	
<i>Fixed laying:</i>	-40°C up to +80°C
<i>Flexible installation:</i>	-20°C up to +60°C
Max. temperature on conductor:	+ 90°C
Max. temperature in short circuit:	+ 250 °C
Min. bending radius:	acc. to DIN VDE 0298, part 3
Current carrying capacity:	acc. to DIN VDE 0298-4
Tensile strength:	up to 15 N/mm ²
Max speed (main application):	240 m/min
Max. torsion:	+/- 100°/m

Features:

mining excavator!

outdoor/indoor use

UV, ozone, and moisture resistant

water resistant: very good

GOST-R WUG and others approvals on request

for SPEED and MINIMUM BENDING RADIUS see pages from 2 to 8 of catalogue

RoHS approval



Applications:

suitable for connections to the excavators in open cast mines are subjected to extremely high mechanical abrasion and tear resistant.

CABLE REELS

FLEXIDRUM® MEDIUM RS-T (N)TSCGEWÖU

From 1,8/3 Kv up to 18/30 Kv, with antitwisting protection

ELETTROTEK KABEL® FLEXIDRUM® MEDIUM RS-T (N)TSCGEWÖU

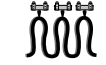

Uo/U (Um) 1,8/3 kV

Part no.	No. of cores x cross section n x mm ²	Outer-Ø ca.mm ± 10%	Copper weight kg/km	Cable weight approx. kg/km	Tensile strenght N	AWG no.®)
02100K71037M63	3x25+3x25/3	37,3	960	2460	1125	4
02100K71037M64	3x35+3x25/3	41,2	1248	3070	1575	2
02100K71037M65	3x50+3x25/3	44,8	1680	3738	2250	1
02100K71037M66	3x70+3x35/3	48,4	2352	4701	6150	2/0
02100K71037M67	3x95+3x50/3	56,7	3216	6202	4275	3/0
02100K71037M68	3x120+3x70/3	60,5	4128	7426	5400	4/0
02100K71037M69	3x150+3x70/3	65,9	4992	8893	6750	250 MCM
02100K71037M70	3x185+3x95/3	70	6240	10340	8325	350 MCM

Uo/U (Um) 3,6/6 kV

Part no.	No. of cores x cross section n x mm ²	Outer-Ø ca.mm ± 10%	Copper weight kg/km	Cable weight approx. kg/km	Tensile strenght N	AWG no.®)
02100M71037M63	3x25+3x25/3	41,8	960	2580	1125	4
02100M71037M64	3x35+3x25/3	44,2	1248	3045	1575	2
02100M71037M65	3x50+3x25/3	47,4	1680	3675	2250	1
02100M71037M66	3x70+3x35/3	54,3	2352	4952	6150	2/0
02100M71037M67	3x95+3x50/3	57,9	3216	5940	4275	3/0
02100M71037M68	3x120+3x70/3	61,2	4128	7212	5400	4/0
02100M71037M69	3x150+3x70/3	66,6	4992	8620	6750	250 MCM
02100M71037M70	3x185+3x95/3	70,5	6240	10030	8325	350 MCM

Uo/U (Um) 6/10 kV

Part no.	No. of cores x cross section n x mm ²	Outer-Ø ca.mm ± 10%	Copper weight kg/km	Cable weight approx. kg/km	Tensile strenght N	AWG no.®)
02100Q71037M63	3x25+3x25/3	43,5	960	2730	1125	4
02100Q71037M64	3x35+3x25/3	45,5	1248	3215	1575	2
02100Q71037M65	3x50+3x25/3	50,1	1680	3835	2250	1
02100Q71037M66	3x70+3x35/3	56	2352	5125	3150	2/0
02100Q71037M67	3x95+3x50/3	59,7	3216	6130	4275	3/0
02100Q71037M68	3x120+3x70/3	64,9	4128	7710	5400	4/0
02100Q71037M69	3x150+3x70/3	67,9	4992	8855	6750	250 MCM
02100Q71037M70	3x185+3x95/3	72,2	6240	10265	8352	350 MCM

CABLE REELS

FLEXIDRUM® MEDIUM RS-T (N)TSCGEWÖU

From 1,8/3 Kv up to 18/30 Kv, with antitwisting protection

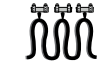

Uo/U (Um) 8,7/15 kV

Part no.	No. of cores x cross section n x mm ²	Outer-Ø ca.mm ± 10%	Copper weight kg/km	Cable weight approx. kg/km	Tensile strenght N	AWG no.®)
02100S71037M63	3x25+3x25/3	48,1	960	3223	1125	4
02100S71037M64	3x35+3x25/3	52,5	1248	3915	1575	2
02100S71037M65	3x50+3x25/3	55,6	1680	4600	2250	1
02100S71037M66	3x70+3x35/3	60,7	2352	5773	3150	2/0
02100S71037M67	3x95+3x50/3	66,2	3216	7268	4275	3/0
02100S71037M68	3x120+3x70/3	69,4	4128	8435	5400	4/0
02100S71037M69	3x150+3x70/3	73,1	4992	9632	6750	250 MCM
02100S71037M70	3x185+3x95/3	78,7	6240	11450	8352	350 MCM

Uo/U (Um) 12/20 kV

* A protective earth conductor design ... 50/3 is also possible for application acc. to DIN VDE 0168

Part no.	No. of cores x cross section n x mm ²	Outer-Ø ca.mm ± 10%	Copper weight kg/km	Cable weight approx. kg/km	Tensile strenght N	AWG no.®)
02100U71037M63*	3x25+3x25/3	54,1	960	3930	1125	4
02100U71037M64*	3x35+3x25/3	56,6	1248	4435	1575	2
02100U71037M65*	3x50+3x25/3	59,8	1680	5175	2250	1
02100U71037M66*	3x70+3x35/3	66,7	2352	6620	3150	2/0
02100U71037M67	3x95+3x50/3	70,3	3216	7930	4275	3/0
02100U71037M68	3x120+3x70/3	73,8	4128	9140	5400	4/0
02100U71037M69	3x150+3x70/3	79,2	4992	10700	6750	250 MCM
02100U71037M70	3x185+3x95/3	82,9	6240	12230	8352	350 MCM

Uo/U (Um) 18/30 kV

Part no.	No. of cores x cross section n x mm ²	Outer-Ø ca.mm ± 10%	Copper weight kg/km	Cable weight approx. kg/km	Tensile strenght N	AWG no.®)
02100X71037M63*	3x25+3x25/3	67,3	960	6670	1125	4
02100X71037M64*	3x35+3x25/3	73,2	1248	7370	1575	2
02100X71037M65*	3x50+3x25/3	74,5	1680	8455	2250	1
02100X71037M66*	3x70+3x35/3	77,7	2352	9670	3150	2/0
02100X71037M67	3x95+3x50/3	82,1	3216	10950	4275	3/0
02100X71037M68	3x120+3x70/3	87,9	4128	12812	5400	4/0
02100X71037M69	3x150+3x70/3	91,6	4992	14230	6750	250 MCM
02100X71037M70	3x185+3x95/3	97,5	6240	16370	8352	350 MCM

Other dimensions and colors available on request.



FLEXIDRUM® MEDIUM SHD GC

From 2 Kv up to 15 Kv



Construction:

Power conductor:	flexible tinned copper conductor, acc. to ASTM B-172
Inner semi-conductive layer:	semi-conducting compound
Insulation:	rubber EPR compound
Power screen:	tinned copper braid with overall colored nylon and semi-conducting compound (non-conducting for 2 and 5 kV)
Outer semi-conductive layer:	semi-conducting compound
Earth conductors:	two finely stranded tinned copper acc. to ASTM B-172 uninsulated
Monitoring conductor:	finely stranded tinned copper acc. to ASTM B-172
Monitoring insulation:	PP compound
Cores color:	Power: natural color with Polyamide braid black, white, red acc. to ICEA S-75-381 Monitoring: yellow semi-conducting compound acc. to ICEA S-75-381 Tab. 3-22
Outer sheath:	black (similar to RAL 9005), rubber CPE compound

Features:

- others colour on request
- mechanical and water protection
- MSHA, CSA and other approvals on request
- two Earth conductors are used giving a total cross sectional area equal to at least 60% of the power conductor
- for MINIMUM BENDING RADIUS see pages from 5 to 8 of catalogue
- RoHS approval



Technical data:

Nominal voltage:	2 kV up to 15 kV
Temperature range:	
<i>Flexible installation:</i>	-50°C up to +90°C
Min. bending radius:	8 x D

Applications:

FLEXIDRUM® MEDIUM cables are designed to provide safe, reliable performance on cable reelers and festoons at temperatures from -50°C to +50°C at speed up to 750 feet/minute. These cables are designed for use on gantry cranes, stacker/reclaimers and other equipment.

CABLE REELS

FLEXIDRUM® MEDIUM SHD GC

From 2 Kv up to 15 Kv



2 kV		POWER	GROUND/MONITORING			
Part no.	AWG no.*)		AWG no.*) Kcmil	Nominal outside diameter (In) ± 10%	Weight approx. lbs. x 1000 ft	Maximum tensile load (lbs)
02110170037A06	6		10/10	1,29	1160	-
02110170037A04	4		8/10	1,4	1490	293
02110170037A02	2		6/10	1,59	2000	466
02110170037A01	1		5/8	1,76	2450	587
02110170037A1C	1/0		4/8	1,86	2840	741
02110170037A2C	2/0		3/8	2	3400	934
02110170037A3C	3/0		2/8	2,13	3680	1178
02110170037A4C	4/0		1/8	2,31	4860	1178
02110170037A5C	250 MCM		1/0 - 6	2,51	5950	1178
02110170037A7C	350 MCM		2/0 - 6	2,81	7400	1178
02110170037AAC	500 MCM		3/0 - 6	3,19	10100	1178

5 kV		POWER	GROUND/MONITORING			
Part no.	AWG no.*)		AWG no.*) Kcmil	Nominal outside diameter (In) ± 10%	Weight approx. lbs. x 1000 ft	Maximum tensile load (lbs)
02110270037A06	6		10/8	1,56	1565	-
02110270037A04	4		8/8	1,7	1920	293
02110270037A02	2		6/8	1,9	2500	466
02110270037A01	1		5/8	1,95	2860	587
02110270037A1C	1/0		4/8	2	3390	741
02110270037A2C	2/0		3/8	2,2	3830	934
02110270037A3C	3/0		2/8	2,35	4418	1178
02110270037A4C	4/0		1/8	2,5	5300	1178
02110270037A5C	250 MCM		1/0 - 6	2,7	6450	1178
02110270037A7C	350 MCM		2/0 - 6	2,95	7880	1178
02110270037AAC	500 MCM		3/0 - 6	3,3	10440	1178

8 kV		POWER	GROUND/MONITORING			
Part no.	AWG no.*)		AWG no.*) Kcmil	Nominal outside diameter (In) ± 10%	Weight approx. lbs. x 1000 ft	Maximum tensile load (lbs)
02110P70037A04	4		8/8	2	2200	293
02110P70037A02	2		6/8	2,2	2850	466
02110P70037A01	1		5/8	2,3	3370	587
02110P70037A1C	1/0		4/8	2,4	3600	741
02110P70037A2C	2/0		3/8	2,5	4200	934
02110P70037A3C	3/0		2/8	2,7	5100	1178
02110P70037A4C	4/0		1/8	2,6	5680	1178
02110P70037A5C	250 MCM		1/0 - 6	2,9	6750	1178
02110P70037A7C	350 MCM		2/0 - 6	3,3	8480	1178
02110P70037AAC	500 MCM		3/0 - 6	3,6	10720	1178

15 kV		POWER	GROUND/MONITORING			
Part no.	AWG no.*)		AWG no.*) Kcmil	Nominal outside diameter (In) ± 10%	Weight approx. lbs. x 1000 ft	Maximum tensile load (lbs)
02110T70037A02	2		6/8	2,5	3520	466
02110T70037A01	1		5/8	2,6	4100	587
02110T70037A1C	1/0		4/8	2,7	4630	741
02110T70037A2C	2/0		3/8	2,9	4900	934
02110T70037A3C	3/0		2/8	3	5600	1178
02110T70037A4C	4/0		1/8	3,1	6830	1178

Other dimensions and colors available on request.

CABLE REELS

FLEXIDRUM® MEDIUM FLAT (N)TSFLCGCWOEUS

Reeling flat cables

ELETTROTEK KABEL® FLEXIDRUM® MEDIUM FLAT (N)TSFLCGCWOEUS

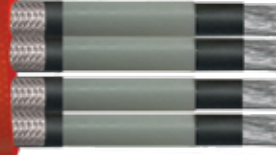

Construction:

Conductor:	flexible tinned copper conductor Cl. 5, acc. to IEC 60228, DIN VDE 0295
Inner semi-conductive layer:	semi-conducting compound
Insulation:	rubber EPR special compound
Outer semi-conductive layer:	semi-conducting compound
Cores color:	Power: natural color with black semi-conducting compound Earth: black semi-conducting compound
Earth conductor screen:	tinned copper braid
Outer sheath:	red (similar to RAL 3000), special PCP compound

Resistance:



Self-extinguishing and flame retardant acc. to:
DIN VDE 0482 part 265-2-1
EN 50265-2-1
IEC 60332-1-2



Oil resistance acc. to:
DIN VDE 0473 part 811-2-1
IEC EN 60811-2-1

Technical data:

Nominal voltage:	U/oU 3,6/6 kV up to 8,7/15 kV
Max. operating voltage in A.C. systems:	Um 1,2 x U
Max. operating voltage in A.C. systems:	Um 1,8 x U
Test voltage:	(acc. to DIN VDE 0250 part 813): 11 kV up to 24 kV in A.C. 27,5 kV up to 60 kV in D.C.
Temperature range:	
<i>Fixed laying:</i>	-50°C up to +80°C
<i>Flexible installation:</i>	-35°C up to +80°C
Max. temperature on conductor:	+ 90°C
Max. temperature in short circuit:	+ 250 °C
Min. bending radius:	acc. to DIN VDE 0298, part 3
Current carrying capacity:	acc. to DIN VDE 0298-4
Tensile strenght:	20 N/mm ²

Features:

outdoor/indoor use
ozone and moisture resistant
reduced cable weight
small outer diameter
possible with integrated optical fiber
for MINIMUM BENDING RADIUS
see pages from 5 to 8 of catalogue
RoHS approval



Applications:

Suitable to operate with forced guidance systems with deflection on different levels and with reel axis in direction of travel.

CABLE REELS

FLEXIDRUM® MEDIUM FLAT (N)TSFLCGCWOEUS

Reeling flat cables

ELETTROTEK KABEL® FLEXIDRUM® MEDIUM FLAT (N)TSFLCGCWOEUS



Uo/U 3,6 (7,2) kV

Part no.	No. of cores x cross section n x mm ²	Outer-Ø ca.mm ± 10%	Copper weight kg/km	Cable weight approx. kg/km	Tensile strength N	AWG no.®)
02120MR1040M64	4x35	24x77 - 25x79	-	3600	2800	2
02120MR1049900	4x35/35+LWL	24x77 - 25x79	-	3600	2100	2
02120MR1040M65	4x50	26x83 - 27x85	-	4400	4000	1
02120MR1049901	3x50/50+LWL	26x83 - 27x85	-	4400	3000	0

Uo/U 6/10 (12) kV

Part no.	No. of cores x cross section n x mm ²	Outer-Ø ca.mm ± 10%	Copper weight kg/km	Cable weight approx. kg/km	Tensile strength N	AWG no.®)
02120QR1040M64	4x35	26x78 - 27x80	-	3900	2800	1
02120QR1049902	3x35/35+LWL	26x78 - 27x80	-	3900	2100	1

Uo/U 8,7/15 (18) kV

Part no.	No. of cores x cross section n x mm ²	Outer-Ø ca.mm ± 10%	Copper weight kg/km	Cable weight approx. kg/km	Tensile strength N	AWG no.®)
02120SR1040M64	4x35	27x79 - 28x81	-	4200	2800	1
02120SR1049903	4x35/35+LWL	27x79 - 28x81	-	4200	2100	1
02120SR1039904	3x35+4x25/4E+6FO62,5/125	28,5x89	1460	4330	-	1

Other dimensions and colors available on request.

FLEXIDRUM® FIBER 770

ELETTROTEK KABEL® FLEXIDRUM® FIBER 770



Construction:

Optical fibers:	core ø: 50 µm, 62,5 µm, 9 µm cladding: 125 µm coating: 250 µm standard type: 62,5/125 (others on request)
Tubes:	Thermoplastic compound
Central unit:	high-tech yarns
Stranding:	fiber-optics around central unit 6-12-18 fiber-optics laying in 6 tubes (1,2 or 3 fibers per tube)
Supporting screen:	anti-twisting protection of synthetic yarns
Outer sheath:	black (similar to RAL 9005), rubber PCP type 5GM2

Resistance:



Self-extinguishing and flame retardant acc. to:
DIN VDE 0482 part 265-2-1
EN 50265-2-1
IEC 60332-1-2



Oil resistance acc. to:
DIN VDE 0473 part 811-2-1
IEC EN 60811-2-1

Technical data:

Temperature range:	
<i>Fixed laying:</i>	-40°C up to +80°C
<i>Flexible installation:</i>	-30°C up to +60°C
Min. bending radius:	15 x D
Max torsion:	± 120°/m
Tensile strength:	1200 N
Max transverse pressure:	300 N/cm
Max speed (main application):	240 m/min

Features:

UV resistant
oil and chemical resistance
for SPEED and MINIMUM BENDING RADIUS
see pages from 2 to 8 of catalogue
RoHS approval



Part no.	No. of cores x cross-section n x mm ²	No. of fibers x tube	Outer-Ø ca. mm ± 10%	Cable weight approx. kg/km	Tensile strength N
0109007F061F62	6G62,5/125 Micron	1	14	230	1200
0109007F061F52	6G50/125 Micron	1	14	230	1200
0109007F06AF09	6E9/125 Micron	1	14	230	1200
0109007F121F62	12G62,5/125 Micron	2	14	230	1200
0109007F121F52	12G50/125 Micron	2	14	230	1200
0109007F12AF09	12E9/125 Micron	2	14	230	1200
0109007F181F62	18G62,5/125 Micron	3	14	230	1200
0109007F181F52	18G50/125 Micron	3	14	230	1200
0109007F18AF09	18E9/125 Micron	3	14	230	1200

Other dimensions and colors available on request.

CABLE REELS

FLEXIDRUM® FIBER 780

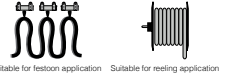

ELETTROTEK KABEL® FLEXIDRUM® FIBER 780

Construction:

Optical fibers:	core ø: 50 µm, 62,5 µm, 9 µm cladding: 125 µm
Central unit:	aramide yarns
Stranding:	fiber-optics around central unit
Inner sheath:	GAALTHERM® 630
Screen:	fiber-glass braid
Outer sheath:	black (similar to RAL 9005), special PUR compound

Resistance:



Self-extinguishing and flame retardant acc. to:
DIN VDE 0482 part 265-2-1
EN 50265-2-1
IEC 60332-1-2



Oil resistance acc. to:
DIN VDE 0473 part 811-2-1
IEC EN 60811-2-1

Technical data:

Temperature range:

<i>Fixed laying:</i>	-40°C up to +90°C
<i>Flexible application:</i>	-30°C up to +70°C

Min. bending radius:

<i>Fixed laying:</i>	6 x D
<i>Flexible installation:</i>	10 x D

Max torsion: ± 120°/m

Tensile strenght: 2000 N

Max transverse pressure: 300 N/cm

Max speed (main application): 240 m/min

Features:

UV resistant

oil and chemical resistance

for SPEED and MINIMUM BENDING RADIUS
see pages from 2 to 8 of catalogue

RoHS approval



Part no.	No. of cores x cross-section n x mm ²	Outer-Ø ca. mm ± 10%	Cable weight approx. kg/km	Tensile strength N
0111007F121F52	12G50/125 Micron	14	170	2000
0111007F121F62	12G62,5/125 Micron	14	170	2000
0111007F12AF09	12E9/125 Micron	14	170	2000
0111007F181F52	18G50/125 Micron	14	170	2000
0111007F181F62	18G62,5/125 Micron	14	170	2000
0111007F18AF09	18E9/125 Micron	14	170	2000
0111007F241F52	24G50/125 Micron	14	170	2000
0111007F241F62	24G62,5/125 Micron	14	170	2000
0111007F24AF09	24E9/125 Micron	14	170	2000

Other dimensions and colors available on request.

FESTOON CABLES



FESTOON CABLES

FLEXIFESTOON® HF-FLAT

Halogen-free flat cables, 0,6/1 kV



ELETTROTEK KABEL® FLEXIFESTOON® HF-FLAT

Construction:

- Conductor:** flexible red copper conductor Cl. 5, acc to IEC 60228, DIN VDE 0295
- Insulation:** GAALTHERM® 532
- Cores color:** acc. to DIN VDE 0293-308, HD 308 S2 from 6 cores black cores with consecutive numbers acc. to EN 50334; green-yellow earth-wire from 3 cores
- Stranding:** cores laying parallel
- Outer sheath:** black (similar to RAL 9005), halogen-free type M1

Resistance:



Self-extinguishing and flame retardant acc. to:
DIN VDE 0482 part 265-2-1
EN 50265-2-1
IEC 60332-1-2



Halogen-free acc. to:
DIN VDE 0482 part 267,
EN 50267-2-1,
IEC 60754-1



Corrosiveness of conflagration gases acc. to:
DIN VDE 0482 part 267
EN 50267-2-2
IEC 60754-2



Low smoke density acc. to:
DIN VDE 0482 part. 268-1-2
EN 50268-1-2
IEC 61034-1-2

Technical data:

- Nominal voltage:** U₀/U 0,6/1 kV
- Test voltage:** 3,5 kV
- Temperature range:**
- Fixed laying:* -40°C up to +80°C
- Flexible application:* -30°C up to +70°C
- Min. bending radius:** 10 x D
- Max speed (main application):** 120 m/min
- Tensile strength:**
- Static:* 15 n/mm²
- Dynamic:* 30 n/mm²

Features:

- indoor/outdoor use
- UV, ozone, and moisture resistant
- for SPEEDS and MINIMUM BENDING RADIUS see pages from 2 to 8 of catalogue
- RoHS and CE approval



Applications:

power and control flat cables are used on FESTOON CABLES and handling equipment. Special design is where halogen-free and low smoke (nuclear plants)

Part no.	No. of cores x cross section n x mm ²	Outer-Ø ca.mm ± 10%	Copper weight kg/km	Cable weight approx. kg/km	AWG no.)*
03020G72041M15	4G1,5	5,9x16,2	57,6	110	16
03020G72041M25	4G2,5	5,8x20	96	200	14
03020G72041M40	4G4	8,8x24,2	153,6	250	12
03020G72041M60	4G6	7,6x25	230,4	420	10
03020G72071M60	7G6	7,8x42	403	760	10
03020G72041M61	4G10	10,4x30,8	384	550	8
03020G72041M62	4G16	11,6x35,6	614,4	800	6
03020G72041M63	4G25	14,1x45,8	960	1350	4
03020G72041M64	4G35	15,8x50,8	1344	1800	2
03020G72041M65	4G50	18,6x60,2	1920	2400	1
03020G72041M66	4G70	21x68	2688	3250	2/0
03020G70071M15	7G1,5	5,4x26	100,8	237	16
03020G70071M25	7G2,5	5,8x32,2	168	345	14
03020G70081M15	8G1,5	5x29	115,2	220	16
03020G70081M25	8G2,5	5x35	192,0	330	14
03020G70121M15	12G1,5	5x44	172,8	440	16
03020G70121M25	12G2,5	5,5x49	288	610	14
03020G70241M10	24G1	4,5x67	230	770	18
03020G70123M25	7x3x1	8,2x39,5	201,6	640	18

Other dimensions and colors available on request.

FESTOON CABLES

FLEXIFESTOON® HF-FLAT CY

Screened Halogen-free flat cables, 0,6/1 kV



ELETTROTEK KABEL® FLEXIFESTOON® HF-FLAT CY

Construction:

Conductor:	flexible red copper conductor Cl. 5, acc to IEC 60228, DIN VDE 0295
Insulation:	GAALTHERM® 532
Cores color:	acc. to DIN VDE 0293-308, HD 308 S2 from 6 cores black cores with consecutive numbers acc. to EN 50334; green-yellow earth-wire from 3 cores
Screen:	red copper braid
Stranding:	cores laying parallel
Outer sheath:	black (similar to RAL 9005), halogen-free type M1

Resistance:



Self-extinguishing and flame retardant acc. to:
DIN VDE 0482 part 265-2-1
EN 50265-2-1
IEC 60332-1-2



Halogen-free acc. to:
DIN VDE 0482 part 267,
EN 50267-2-1,
IEC 60754-1



Corrosiveness of conflagration gases acc. to:
DIN VDE 0482 part 267
EN 50267-2-2
IEC 60754-2



Low smoke density acc. to:
DIN VDE 0482 part. 268-1-2
EN 50268-1-2
IEC 61034-1-2

Technical data:

Nominal voltage:	U ₀ /U 0,6/1 kV
Test voltage:	3,5 kV
Temperature range:	
<i>Fixed laying:</i>	-40°C up to +80°C
<i>Flexible application:</i>	-30°C up to +70°C
Min. bending radius:	10 x D
Max speed (main application):	120 m/min
Tensile strength:	
<i>Static:</i>	15 n/mm ²
<i>Dynamic:</i>	30 n/mm ²

Features:

Indoor/outdoor use
UV, ozone, and moisture resistant
for SPEEDS and MINIMUM BENDING RADIUS
see pages from 2 to 8 of catalogue
RoHS and CE approval



Applications:

power and control flat cables are used on FESTOON CABLES and handling equipment. Special design is where halogen-free and low smoke (nuclear plants)

Part no.	No. of cores x cross section n x mm ²	Outer-Ø ca.mm ± 10%	Copper weight kg/km	Cable weight approx. kg/km	AWG no.®)
03230G72041M25	4G2,5	5,8x20	133	292	14
03230G72041M60	4G6	7,9x25,4	313	610	10
03230G72041M61	4G10	10x31,8	522	945	8
03230G70121M15	12G1,5	6x49,3	267	580	16
03230G70121M25	12G2,5	5,8x60	421	775	14

Other dimensions and colors available on request.

FESTOON CABLES

FLEXIFESTOON® NE-FLAT (N)GFLGÖU-J

Rubber flat cables, 0,6/1 kV

ELETTROTEK KABEL® FLEXIFESTOON® NE-FLAT (NGFLGÖU-J)



Construction:

Conductor:	flexible red copper conductor Cl. 6, acc to IEC 60228, DIN VDE 0295 (<=25 mm ²) Flexible red copper conductor Cl. 5, acc to IEC 60228, DIN VDE 0295 (>=35 mm ²)
Insulation:	EPR type 3GI3 acc. to DIN VDE 0207
Cores color:	acc. to DIN VDE 0293-308, HD 308 S2 from 6 cores black cores with consecutive numbers acc. to EN 50334; green-yellow earth-wire from 3 cores
Stranding:	cores laying parallel
Outer sheath:	black (similar to RAL 9005), rubber PCP type 5GM3

Resistance:



Self-extinguishing and flame retardant acc. to:
DIN VDE 0482 part 265-2-1
EN 50265-2-1
IEC 60332-1-2



Oil resistance acc. to:
DIN VDE 0473 part 811-2-1
IEC EN 60811-2-1

Technical data:

Nominal voltage:	U ₀ /U 0,6/1 kV
Test voltage:	4 kV
Temperature range:	
<i>Fixed laying:</i>	-40°C up to +80°C
<i>Flexible application:</i>	-30°C up to +80°C
Max. temp on conductor:	
<i>In service:</i>	up to +90°C
<i>In short circuit:</i>	up to +250°C
Min. bending radius:	acc. to DIN VDE 0298 part 3
Tensile strenght:	
<i>Static:</i>	15 n/mm ²
<i>Dynamic:</i>	30 n/mm ²
Max speed (main application):	up to 180 m/min

Features:

UV, ozone, chemical and resistant
Indoor/outdoor use
minimum waste of space
high flexibility
acc. to DIN VDE 0250-809
for SPEEDS and MINIMUM BENDING RADIUS
see pages from 2 to 8 of catalogue
RoHS and CE approval



FESTOON CABLES

FLEXIFESTOON® NE-FLAT (N)GFLGÖU-J

Rubber flat cables, 0,6/1 kV



Suitable for festoon application

Part no.	No. of cores x cross section n x mm ²	Outer-Ø ca.mm ± 10%	Copper weight kg/km	Cable weight approx. kg/km	AWG no.*)
03010G72041M15	4G1,5	7,2x16,3	57,6	170	16
03010G72051M15	5G1,5	7,2x20,5	72	225	16
03010G70071M15	7G1,5	7,2x26,9	100,8	320	16
03010G70081M15	8G1,5	7,2x31,1	115,2	375	16
03010G70101M15	10G1,5	7,8x39,1	144	505	16
03010G70121M15	12G1,5	7,8x46,5	172,8	615	16
03010G72041M25	4G2,5	8,6x19,9	96	260	14
03010G72051M25	5G2,5	8,6x24,9	120	340	14
03010G70061M25	6G2,5	8,6x28,8	144	415	14
03010G70071M25	7G2,5	8,6x32,8	168	485	14
03010G70081M25	8G2,5	8,6x37,7	192	565	14
03010G70121M25	12G2,5	9,2x56,1	288	915	14
03010G72041M40	4G4	9,9x23,5	153,6	375	12
03010G72041M40	5G4	9,9x29,2	192	490	12
03010G70071M40	7G4	9,9x38,6	268,8	700	12
03010G72041M60	4G6	10,4x26,5	230,4	480	10
03010G72041M60	5G6	10,4x31,7	288	610	10
03010G70071M60	7G6	10,4x42,1	403,2	880	10
03010G72041M61	4G10	11,9x31,5	384	695	8
03010G72041M61	5G10	11,9x39,2	480	915	8
03010G72041M62	4G16	13,4x35,7	614,4	950	6
03010G72041M63	4G25	14,9x42,7	960	1390	4
03010G72041M64	4G35	16,6x47,7	1344	1800	2
03010G72041M65	4G50	18,6x55,7	1920	2435	1

Other dimensions and colors available on request.

FLEXIFESTOON® NE-FLAT CY (N)GFLCGÖU

Screened rubber flat cables, 0,6/1 kV

ELETTROTEK KABEL® FLEXIFESTOON® NE-FLAT CY ((N)GFLCGÖU)



Construction:

- Conductor:** flexible red copper conductor Cl. 6, acc to IEC 60228, DIN VDE 0295 (<=25 mm²)
Flexible red copper conductor Cl. 5, acc to IEC 60228, DIN VDE 0295 (>=35 mm²)
- Insulation:** EPR type 3GI3 acc. to DIN VDE 0207
- Cores color:** acc. to DIN VDE 0293-308, HD 308 S2 from 6 cores black cores with consecutive numbers acc. to EN 50334; green-yellow earth-wire from 3 cores
- Stranding:** cores laying parallel
- Screen:** tinned copper braid
- Outer sheath:** black (similar to RAL 9005), rubber PCP type 5GM3

Resistance:



Self-extinguishing and flame retardant acc. to:
DIN VDE 0482 part 265-2-1
EN 50265-2-1
IEC 60332-1-2



Oil resistance acc. to:
DIN VDE 0473 part 811-2-1
IEC EN 60811-2-1

Technical data:

- Nominal voltage:** U₀/U 0,6/1 kV
- Test voltage:** 4 kV
- Temperature range:**
Fixed laying: -40°C up to +80°C
Flexible application: -30°C up to +80°C
- Max. temp on conductor:**
In service: up to +90°C
In short circuit: up to +250°C
- Min. bending radius:** acc. to DIN VDE 0298 part 3
- Max speed (main application):** 180 m/min
- Tensile strength:**
Static: 15 n/mm²
Dynamic: 30 n/mm²

Features:

- UV, ozone, chemical and resistant
- Indoor/outdoor use
- minimum waste of space
- high flexibility
- acc. to DIN VDE 0250-809
- for SPEEDS and MINIMUM BENDING RADIUS see pages from 2 to 8 of catalogue
- RoHS and CE approval



Part no.	No. of cores x cross section n x mm ²	Outer-Ø ca.mm ± 10%	Copper weight kg/km	Cable weight approx. kg/km	AWG no.®)
03040G72041M15	4G1,5	8x19,4	120	245	16
03040G70081M15	8G1,5	8x37,4	235	540	16
03040G70101M15	10G1,5	8,6x46,9	280	725	16
03040G70121M15	12G1,5	8,6x55,9	365	880	16
03040G72041M25	4G2,5	8,8x23	170	335	14
03040G70061M25	6G2,5	8,8x32,5	275	535	14
03040G70121M25	12G2,5	9,4x62,5	580	1180	14
03040G72041M40	4G4	9,2x26,8	245	435	12
03040G72041M60	4G6	9,9x29,5	360	565	10
03040G72041M61	4G10	11,4x35,7	540	805	8
03040G72041M62	4G16	12,9x39,9	810	1080	6
03040G72041M63	4G25	14,4x46,9	1205	1535	4
03040G72041M64	4G35	16,5x53,5	1660	2085	2
03040G72041M65	4G50	18,5x61,5	2265	2755	1
03040G70042A18	4x(2x)C	32x12	305	1054	18
03040G70072A18	7x(2x1)C	57x12	200	570	18
03040G70122A18	12x(2x1)C	68x15,3	600	1640	18

Other dimensions and colors available on request.

FLEXIFESTOON® NE-FLAT (NGFLGÖU) UL



Construction:

Conductor:	flexible red copper conductor Cl. 6, acc to IEC 60228, DIN VDE 0295 (from 1 up to 25 mm ²) Flexible red copper conductor Cl. 5, acc to IEC 60228, DIN VDE 0295 (from 35 mm ²)
Insulation:	EPR type 3GI3 acc. to DIN VDE 0207
Cores color:	acc. to DIN VDE 0293-308, HD 308 S2 from 6 cores black cores with consecutive numbers acc. to EN 50334; green-yellow earth-wire from 3 cores
Stranding:	cores laying parallel
Outer sheath:	black (similar to RAL 9005), rubber PCP type 5GM3, yellow (similar to RAL 1021) on request

Resistance:



Self-extinguishing and flame retardant acc. to:
DIN VDE 0482 part 265-2-1
EN 50265-2-1
IEC 60332-1-2



Oil resistance acc. to:
DIN VDE 0473 part 811-2-1
IEC EN 60811-2-1

Technical data:

Nominal voltage:	U _o /U 300/500 V (UL 600 V)
Test voltage:	3 kV
Temperature range:	
<i>Fixed laying:</i>	-40°C up to +85°C
<i>Flexible application:</i>	-35°C up to +85°C
Max. temp on conductor:	
<i>In service:</i>	up to +90°C
<i>In short circuit:</i>	up to +250°C
Min. bending radius:	acc. to DIN VDE 0298 part 3
Max speed (main application):	180 m/min

Features:

- UV, ozone, and chemical resistant
- extremely small bending radius
- minimum waste of space
- high flexibility
- cold resistant
- UL listed approval available on request
- AWM style 4540 90°C 600 V FT-1 600 V**
- for SPEEDS and MINIMUM BENDING RADIUS see pages from 2 to 8 of catalogue
- RoHS and CE approval



FESTOON CABLES

FLEXIFESTOON® NE-FLAT (NGFLGÖU) UL



Part no.	No. of cores x cross section n x mm ²	Outer-Ø ca.mm ± 10%	Copper weight kg/km	Cable weight approx. kg/km	AWG no.*)
03030F72041A16	4G1,5	5,4x16,3	58	200	16
03030F72051A16	5G1,5	5,4x20,9	72	250	16
03030F70071A16	7G1,5	5,4x27,6	101	310	16
03030F70081A16	8G1,5	5,4x30,7	115	350	16
03030F70101A16	10G1,5	6,1x39,2	144	480	16
03030F70121A16	12G1,5	6,1x45,5	173	560	16
03030F70241A16	24G1,5	12,5x53,5	345,6	1170	16
03030F72041A14	4G2,5	6,8x19,7	96	290	14
03030F72051A14	5G2,5	6,8x25	120	360	14
03030F70071A14	7G2,5	6,8x32	168	500	14
03030F70081A14	8G2,5	6,8x36,5	192	520	14
03030F70101A14	10G2,5	6,8x42	240	690	14
03030F70121A14	12G2,5	8,2x52,8	288	810	14
03030F70241A14	24G2,5	16x69,3	576	1600	14
03030F72041A12	4G4	8,1x23,3	154	400	12
03030F72051A12	5G4	8,1x28	192	530	12
03030F70071A12	7G4	8,1x38,3	269	690	12
03030F70121A12	12G4	8,4x61,9	460,8	1131	12
03030F70041A10	4G6	8,9x26,4	230	550	10
03030F72051A10	5G6	8,9x33,2	288	620	10
03030F70071A10	7G6	8,9x43,9	403	920	10
03030F72041A08	4G10	10,2x31,8	384	800	8
03030F72051A08	5G10	10,2x39,8	480	1000	8
03030F70071A08	7G10	10,2x53,3	672	1400	8
03030F72041A06	4G16	12,0x37,2	614	1120	6
03030F72051A06	5G16	12,0x50	768	1420	6
03030F70071A06	7G16	12,5x63,5	1075	2360	6
03030F72041A04	4G25	13,2x43	960	1480	4
03030F72051A04	5G25	13,2x60	1200	2210	4
03030F70071A04	7G25	14,5x74,8	1680	3250	4
03030F72041A02	4G35	15,6x49,7	1344	2190	2
03030F70071A02	7G35	16,2x85,5	2352	4150	2
03030F72041A01	4G50	18,1x58,5	1920	3030	1
03030F72041A2C	4G70	21x69,3	2688	4340	2/0
03030F72041A3C	4G95	23,5x76,8	3648	5120	3/0
03030F72041A4C	4G120	25,8x85,5	4608	6350	4/0

Other dimensions and colors available on request.

FLEXIFESTOON® NE FLAT M(StD)HÖU-J/O UL

Screened rubber flat cables, UL approval



ELETTROTEK KABEL® FLEXIFESTOON® NE-FLAT M(StD)HÖU-J/O UL
UL style 4540 90°C 600 V FT-1 600 V

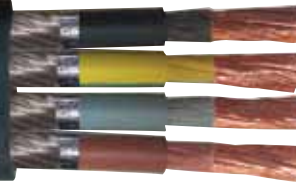

Construction:

Conductor:	flexible red copper conductor Cl. 6, acc to IEC 60228, DIN VDE 0295 (from 1 up to 25 mm ²) Flexible red copper conductor Cl. 5, acc to IEC 60228, DIN VDE 0295 (from 35 mm ²)
Wrapping:	PETP tape
Insulation:	rubber HEPR type 3GI3 acc. to DIN VDE 0207
Cores color:	acc. to DIN VDE 0293-308, HD 308 S2 from 6 cores black cores with consecutive numbers acc. to EN 50334; green-yellow earth-wire from 3 cores
Stranding:	cores laying parallel pairs: cores twisted in pairs with short lay length wrapping with PETP foil, pairs laying parallel
Screen:	tinned copper wires + aluminium tape/PETP foil
Outer sheath:	black (similar to RAL 9005), rubber PCP type 5GM3

Resistance:



Self-extinguishing and flame retardant acc. to:
DIN VDE 0482 part 265-2-1
EN 50265-2-1
IEC 60332-1-2



Oil resistance acc. to:
DIN VDE 0473 part 811-2-1
IEC EN 60811-2-1

Technical data:

Nominal voltage:	U ₀ /U 0,6/1 kV (UL 600 V)
Test voltage:	4 kV
Temperature range:	
<i>UL:</i>	up to +90°C
<i>Fixed laying:</i>	-40°C up to +85°C
<i>Flexible application:</i>	-30°C up to +85°C
Max. temp on conductor:	
<i>In service:</i>	up to +90°C
<i>In short circuit:</i>	up to +250°C
Min. bending radius:	acc. to DIN VDE 0298 part 3
Max speed (main application):	180 m/min
Radiation resistance:	up to 50x10 ⁶ cJ/kg (up to 50 Mrad)
Tensile strength:	
<i>Static:</i>	15 N/mm ²
<i>Dynamic:</i>	30 N/mm ²

Features:

UV, ozone, and chemical resistant
extremely small bending radius
minimum waste of space
high flexibility
cold resistant
acc. to DIN VDE 0250 part 809 table 2
UL listed approval available on request
AWM style 4540 90°C 600 V FT-1 600 V
for SPEEDS and MINIMUM BENDING RADIUS
see pages from 2 to 8 of catalogue
RoHS and CE approval



FESTOON CABLES

FLEXIFESTOON® NE FLAT M(StD)HÖU-J/O UL

Screened rubber flat cables, UL approval



ELETTROTEK KABEL® FLEXIFESTOON® NE-FLAT M(SID)HÖU-J/O UL
UL style 4540 90°C 600 V FT-1 600 V



Suitable for festoon application

Part no.	No. of cores x cross section n x mm ²	Outer-Ø ca.mm ± 10%	Copper weight kg/km	Cable weight approx. kg/km	AWG no.®)
03190F72041A16	4G1,5	20,8x7,5	99	291	16
03190F72051A16	5G1,5	24,8x7,5	124	350	16
03190F70081A16	8G1,5	38,1x7,5	228	537	16
03190F71080A16	8x1,5	38,1x7,5	228	537	16
03190F70121A16	12G1,5	55,3x7,5	343	795	16
03190F71120A16	12x1,5	55,3x7,5	343	795	16
03190F72041A14	4G2,5	23,4x8,2	163	418	14
03190F70061A14	6G2,5	32,5x8,2	245	535	14
03190F70121A16	12G2,5	63x8,2	493	1004	14
03190F72041A12	4G4	26,8x9	241	440	12
03190F72041A10	4G6	29,7x9,7	353	603	10
03190F72041A08	4G10	35,9x11,7	497	955	8
03190F72041A06	4G16	39,9x13,1	805	1254	6
03190F72041A04	4G25	45,5x14,2	1200	1694	4
03190F72041A02	4G35	53,1x16,4	1657	2282	2
03190F72041A01	4G50	63,2x19,2	2261	3130	1
03190F72041A2C	4G70	75x22,9	3259	4680	2/0
03190F72041A3C	4G95	79,1x24	4311	5605	3/0
03190F70042A18	4x(2x1)StD	32x11,7	156	525	18
03190F70072A18	7x(2x1)StD	57,5x11,7	205	909	18
03190F70122A18	12x(2x1)StD	68,3x15,4	460	1500	18
03190F70122A18	4x(4G1,5)StD	40,6x11,5	440	900	16

Other dimensions and colors available on request.

FLEXIFESTOON® SPECIAL NE-FLAT

Rubber flat cables



ELETTROTEK KABEL® FLEXIFESTOON® SPECIAL NE-FLAT

Construction:

- Conductor:** flexible red copper conductor Cl. 6, acc to IEC 60228, DIN VDE 0295 (from 1 up to 25 mm²)
Flexible red copper conductor Cl. 5, acc to IEC 60228, DIN VDE 0295 (from 35 mm² up to 90 mm²)
- Insulation:** **GAALTHERM® 533:** identified with "4", on the 5th number of the Part no.,
or XLPE compound: identified with "5", on the 5th number of the Part no.
- Cores color:** acc. to DIN VDE 0293-308, HD 308 S2 from 6 cores black cores with consecutive numbers acc. to EN 50334; green-yellow earth-wire from 3 cores
- Stranding:** cores laying parallel
- Outer sheath:** black (similar to RAL 9005), GAALTHERM® 533

Resistance:



Self-extinguishing and flame retardant acc. to:
DIN VDE 0482 part 265-2-1
EN 50265-2-1
IEC 60332-1-2



Halogen-free acc. to:
DIN VDE 0482 part 267,
EN 50267-2-1,
IEC 60754-1



Oil resistance acc. to:
DIN VDE 0473 part 811-2-1
IEC EN 60811-2-1

Technical data:

- Nominal voltage:** U₀/U 0,6/1 kV
- Test voltage:** 4 kV
- Temperature range:**
GAALTHERM® 533:
Fixed laying: -40°C up to +135°C
Flexible application: -25°C up to +125 °C
XLPE compound:
Fixed laying: -20°C up to +90°C
Flexible application: -10°C up to +90°C
- Max. temp on conductor:**
In service: up to +90°C
In short circuit: up to +250°C
- Min. bending radius:** 10 x D
- Max speed (main application):** 180 m/min
- Radiation resistance:** up to 50x10⁶ cJ/kg (up to 50 Mrad)
- Tensile strenght:** 25 N/mm²

Features:

- Max. temperature up to +125°C on flexible applications!**
- UV, ozone, and chemical resistant
- extremely small bending radius
- minimum waste of space
- high flexibility
- acc. to IEC 60502-1 standard
- for SPEEDS and MINIMUM BENDING RADIUS see pages from 2 to 8 of catalogue
- RoHS and CE approval



FESTOON CABLES

FLEXIFESTOON® SPECIAL NE-FLAT

Rubber flat cables



ELETTROTEK KABEL® FLEXIFESTOON® SPECIAL NE-FLAT



GAALTHERM® 533 Type

Part no.	No. of cores x cross section n x mm ²	Outer-Ø ca.mm ± 10%	Copper weight kg/km	Cable weight approx. kg/km	AWG no.*)
03014G72041M15	4G1,5	5x14,2	58	148	16
03014G72051M15	5G1,5	5x18,4	72	184	16
03014G70071M15	7G1,5	5x24	101	250	16
03014G70081M15	8G1,5	5x27,3	115	270	16
03014G71080M15	8x1,5	5,5x29,5	115	315	16
03014G70091M15	9G1,5	5,5x32,5	130	345	16
03014G70101M15	10G1,5	5x34	144	347	16
03014G70121M15	12G1,5	5x39,4	173	436	16
03014G70161M15	16G1,5	5x52	230,4	570	16
03014G70181M15	18G1,5	5,5x58,5	259,2	635	16
03014G70241M15	24G1,5	5,5x80,5	346	875	16
03014G72041M25	4G2,5	6,5x18	96	230	14
03014G72051M25	5G2,5	6,5x22,5	120	281	14
03014G70071M25	7G2,5	6,5x31,3	168	369	14
03014G70081M25	8G2,5	6,5x32,9	192	414	14
03014G70121M25	12G2,5	6,8x48,1	288	605	14
03014G70161M25	16G2,5	6,8x56,1	384	700	14
03014G70181M25	18G2,5	6,8x75	432	925	14
03014G70241M25	24G2,5	6,8x121	576	975	14
03014G72041M40	4G4	7,5x21,8	154	344	12
03014G72051M40	5G4	7,5x27,4	192	428	12
03014G70071M40	7G4	7,9x36,6	269	590	12
03014G70121M40	12G4	7,5x57	460,8	880	12
03014G72041M60	4G6	8,2x24,8	230	424	10
03014G72051M60	5G6	8,2x31,8	288	530	10
03014G72071M60	7G6	8,2x42,6	403	760	10
03014G72041M61	4G10	10x29,6	384	710	8
03014G72041M62	4G16	11,2x34,4	614	1014	6
03014G72041M63	4G25	13,7x42,6	960	1365	4
03014G72041M64	4G35	15,4x47,6	1344	2100	2
03014G72041M65	4G50	18,2x57	1920	2940	1
03014G72041M66	4G70	20x64,2	2688	4090	2/0
03014G72041M67	4G95	20,5x72,5	3684	4550	3/0
03014G72041M69	4G150	25x84	5760	6620	250 MCM
03014G72051M40	5G4	6,9x26	192	390	12
03014G72051M60	5G6	7,6x29,5	288	530	10
03014G72051M61	5G10	9,4x36,5	480	868	8
03014G72051M62	5G16	13x46,6	768	1370	6
03014G72051M63	5G25	15,5x55,5	1200	2000	4

Other dimensions and colors available on request.

FESTOON CABLES

FLEXIFESTOON® SPECIAL NE-FLAT

Rubber flat cables



ELETTROTEK KABEL® FLEXIFESTOON® SPECIAL NE-FLAT

XLPE Type

Part no.	No. of cores x cross section n x mm ²	Outer-Ø ca.mm ± 10%	Copper weight kg/km	Cable weight approx. kg/km	AWG no.*)
03015G72041M15	4G1,5	5x14,2	58	148	16
03015G72051M15	5G1,5	5x18,4	72	184	16
03015G70071M15	7G1,5	5x24	101	250	16
03015G70081M15	8G1,5	5x27,3	115	270	16
03015G71080M15	8x1,5	5,5x29,5	115	315	16
03015G70091M15	9G1,5	5,5x32,5	130	345	16
03015G70101M15	10G1,5	5x34	144	347	16
03015G70121M15	12G1,5	5x39,4	173	436	16
03015G70161M15	16G1,5	5x52	230,4	570	16
03015G70181M15	18G1,5	5,5x58,5	259,2	635	16
03015G70241M15	24G1,5	5,5x80,5	346	875	16
03015G72041M25	4G2,5	6,5x18	96	230	14
03015G72051M25	5G2,5	6,5x22,5	120	281	14
03015G70071M25	7G2,5	6,5x31,3	168	369	14
03015G70081M25	8G2,5	6,5x32,9	192	414	14
03015G70121M25	12G2,5	6,8x48,1	288	605	14
03015G70161M25	16G2,5	6,8x56,1	384	700	14
03015G70181M25	18G2,5	6,8x75	432	925	14
03015G70241M25	24G2,5	6,8x121	576	975	14
03015G72041M40	4G4	7,5x21,8	154	344	12
03015G72051M40	5G4	7,5x27,4	192	428	12
03015G70071M40	7G4	7,9x36,6	269	590	12
03015G70121M40	12G4	7,5x57	460,8	880	12
03015G72041M60	4G6	8,2x24,8	230	424	10
03015G72051M60	5G6	8,2x31,8	288	530	10
03015G72071M60	7G6	8,2x42,6	403	760	10
03015G72041M61	4G10	10x29,6	384	710	8
03015G72041M62	4G16	11,2x34,4	614	1014	6
03015G72041M63	4G25	13,7x42,6	960	1365	4
03015G72041M64	4G35	15,4x47,6	1344	2100	2
03015G72041M65	4G50	18,2x57	1920	2940	1
03015G72041M66	4G70	20x64,2	2688	4090	2/0
03015G72041M67	4G95	20,5x72,5	3684	4550	3/0
03015G72041M69	4G150	25x84	5760	6620	250 MCM
03015G72051M40	5G4	6,9x26	192	390	12
03015G72051M60	5G6	7,6x29,5	288	530	10
03015G72051M61	5G10	9,4x36,5	480	868	8
03015G72051M62	5G16	13x46,6	768	1370	6
03015G72051M63	5G25	15,5x55,5	1200	2000	4

Other dimensions and colors available on request.

FESTOON CABLES

FLEXIFESTOON® SPECIAL NE-FLAT CY

Screened rubber flat cables



ELETTROTEK KABEL® FLEXIFESTOON® SPECIAL NE-FLAT CY

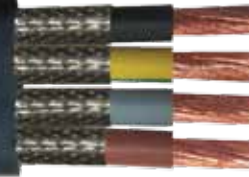

Construction:

Conductor:	flexible red copper conductor Cl. 6, acc to IEC 60228, DIN VDE 0295 (from 1 up to 25 mm ²) Flexible red copper conductor Cl. 5, acc to IEC 60228, DIN VDE 0295 (from 35 mm ² up to 120 mm ²)
Insulation:	GAALTHERM® 533: identified with "4", on the 5 th number of the Part no., or XLPE compound: identified with "5", on the 5 th number of the Part no.
Cores color:	acc. to DIN VDE 0293-308, HD 308 S2 from 6 cores black cores with consecutive numbers acc. to EN 50334; green-yellow earth-wire from 3 cores
Stranding:	cores laying parallel
Screen:	tinned copper braid
Outer sheath:	black (similar to RAL 9005), GAALTHERM® 533

Resistance:



Self-extinguishing and flame retardant acc. to:
DIN VDE 0482 part 265-2-1
EN 50265-2-1
IEC 60332-1-2



Halogen-free acc. to:
DIN VDE 0482 part 267,
EN 50267-2-1,
IEC 60754-1



Oil resistance acc. to:
DIN VDE 0473 part 811-2-1
IEC EN 60811-2-1

Technical data:

Nominal voltage:	U ₀ /U 0,6/1 kV
Test voltage:	4 kV
Temperature range:	
GAALTHERM® 533:	
<i>Fixed laying:</i>	-40°C up to +135°C
<i>Flexible application:</i>	-25°C up to +125 °C
XLPE compound:	
<i>Fixed laying:</i>	-20°C up to +90°C
<i>Flexible application:</i>	-10°C up to +90°C
Max. temp on conductor:	
<i>In service:</i>	up to +90°C
<i>In short circuit:</i>	up to +250°C
Min. bending radius:	10 x D
Max speed (main application):	180 m/min
Radiation resistance:	up to 50x10 ⁶ cJ/kg (up to 50 Mrad)
Tensile strenght:	25 N/mm ²

Features:

max. temperature up to +125°C on flexible applications!

UV, ozone, and chemical resistant

extremely small bending radius

minimum waste of space

high flexibility

acc. to IEC 60502-1 standard

for SPEEDS and MINIMUM BENDING RADIUS
see pages from 2 to 8 of catalogue

RoHS and CE approval



FESTOON CABLES

FLEXIFESTOON® SPECIAL NE-FLAT CY

Screened rubber flat cables



ELETTROTEK KABEL® FLEXIFESTOON® SPECIAL NE-FLAT CY

GAALTHERM® 533 Type

Part no.	No. of cores x cross section n x mm ²	Outer-Ø ca.mm ± 10%	Copper weight kg/km	Cable weight approx. kg/km	AWG no.*)
03044G72041M15	4G1,5	6x19	125	250	16
03044G70071M15	7G1,5	7,4x21,5	165	330	16
03044G70081M15	8G1,5	6x34,5	180	460	16
03044G70121M15	12G1,5	6x50,5	270	615	16
03044G72041M25	4G2,5	7x22	153	320	14
03044G72051M25	5G2,5	7x36,9	210	440	14
03044G70061M25	6G2,5	7x38,4	225	470	14
03044G70071M25	7G2,5	7x49,2	235	515	14
03044G70121M25	12G2,5	7x60	405	590	14
03044G72041M40	4G4	7,5x23	222	360	12
03044G72041M60	4G6	9x29	313	580	10
03044G72041M61	4G10	10,7x36	522	900	8
03044G72041M62	4G16	14x46	784	1280	6
03044G72041M63	4G25	14,5x50	1163	1800	4
03044G72041M64	4G35	16x55	1549	2300	2

Other dimensions and colors available on request.

XLPE Type

Part no.	No. of cores x cross section n x mm ²	Outer-Ø ca.mm ± 10%	Copper weight kg/km	Cable weight approx. kg/km	AWG no.*)
03045G72041M15	4G1,5	6x19	125	250	16
03045G70071M15	7G1,5	7,4x21,5	165	330	16
03045G70081M15	8G1,5	6x34,5	180	460	16
03045G70121M15	12G1,5	6x50,5	270	615	16
03045G72041M25	4G2,5	7x22	153	320	14
03045G72051M25	5G2,5	7x36,9	210	440	14
03045G70061M25	6G2,5	7x38,4	225	470	14
03045G70071M25	7G2,5	7x49,2	235	515	14
03045G70121M25	12G2,5	7x60	405	590	14
03045G72041M40	4G4	7,5x23	222	360	12
03045G72041M60	4G6	9x29	313	580	10
03045G72041M61	4G10	10,7x36	522	900	8
03045G72041M62	4G16	14x46	784	1280	6
03045G72041M63	4G25	14,5x50	1163	1800	4
03045G72041M64	4G35	16x55	1549	2300	2

Other dimensions and colors available on request.

FLEXIFESTOON® PV-FLAT (H07VVH6-F)

HAR

ELETTROTEK KABEL® FLEXIFESTOON® PV-FLAT (H07VVH6-F)

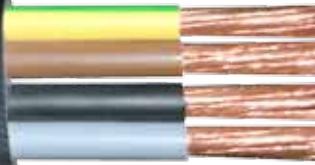

Suitable for festoon application

Construction:

Conductor:	flexible red copper conductor Cl. 5, acc to IEC 60228, DIN VDE 0295
Insulation:	PVC type T12
Cores color:	acc. to DIN VDE 0293-308, HD 308 S2 from 6 cores black cores with consecutive numbers acc. to EN 50334; green-yellow earth-wire from 3 cores
Stranding:	cores laying parallel
Outer sheath:	black (similar to RAL 9005), special PVC compound

Resistance:



Self-extinguishing and flame retardant acc. to:
DIN VDE 0482 part 265-2-1
EN 50265-2-1
IEC 60332-1-2



Oil resistance acc. to:
DIN VDE 0473 part 811-2-1
IEC EN 60811-2-1

Technical data:

Nominal voltage:	U ₀ /U 450/750 V
Test voltage:	2,5 kV
Temperature range:	
<i>Fixed laying:</i>	-25°C up to +70°C
<i>Flexible application:</i>	-20°C up to +70°C
Max. temp on conductor:	
<i>In service:</i>	up to +70°C
<i>In short circuit:</i>	up to +150°C
Min. bending radius:	acc. to DIN VDE 0298 part 3
Radiation resistance:	up to 80x10 ⁶ cJ/kg (up to 80 Mrad)
Tensile strenght:	
<i>Static:</i>	15 n/mm ²
<i>Dynamic:</i>	30 n/mm ²
Max speed (main application):	120 m/min

Features:

UV, ozone and chemical resistant
on request 0,6/1 kV version
minimum waste of space
high flexibility
for SPEEDS and MINIMUM BENDING RADIUS
see pages from 2 to 8 of catalogue
RoHS and CE approval



FESTOON CABLES

FLEXIFESTOON® PV-FLAT (H07VVH6-F)

HAR

ELETTROTEK KABEL® FLEXIFESTOON® PV-FLAT (H07VVH6-F)



Part no.	No. of cores x cross section n x mm ²	Outer-Ø ca.mm ± 4%	Copper weight kg/km	Cable weight approx. kg/km	AWG no.®)
03050E72041M15	4G1,5	4,9x14,8	58	135	16
03050E72051M15	5G1,5	4,9x18	72	169	16
03050E70071M15	7G1,5	4,9x24,5	101	235	16
03050E70081M15	8G1,5	4,9x27,6	115	267	16
03050E71080M15	8x1,5	4,9x27,6	115	267	16
03050E70091M15	9G1,5	4,9x30,8	130	302	16
03050E70101M15	10G1,5	4,9x34,1	144	332	16
03050E70121M15	12G1,5	4,9x40,7	173	400	16
03050E70161M15	16G1,5	4,9x53,7	230,4	535	16
03050E70181M15	18G1,5	4,9x60,2	259,2	603	16
03050E70241M15	24G1,5	4,9x79,7	346	761	16
03050E72041M25	4G2,5	5,6x17,9	96	200	14
03050E72051M25	5G2,5	5,6x22	120	256	14
03050E70071M25	7G2,5	5,6x30	168	344	14
03050E70081M25	8G2,5	5,6x34,1	192	395	14
03050E70121M25	12G2,5	5,6x50,2	288	590	14
03050E70161M25	16G2,5	5,6x66,3	384	785	14
03050E70181M25	18G2,5	5,6x74,4	432	880	14
03050E70064M25	6x(4G2,5)	15x63	576	1024	14
03050E70241M25	24G2,5	5,6x98,6	576	1024	14
03050E72041M40	4G4	6,5x20	154	277	12
03050E72051M40	5G4	6,5x24,6	192	350	12
03050E70071M40	7G4	6,5x33,8	269	490	12
03050E70121M40	12G4	6,5x56,8	460,8	840	12
03050E72041M60	4G6	7x22,2	230	360	10
03050E72051M60	5G6	7x27,3	288	470	10
03050E72071M60	7G6	7x37,5	403	655	10
03050E72041M61	4G10	8,8x27,6	384	590	8
03050E72051M61	5G10	8,8x34,8	480	720	8
03050E72041M62	4G16	10x32	614	840	6
03050E72051M62	5G16	10x39,8	768	1036	6
03050E72041M63	4G25	11,9x38,8	960	1255	4
03050E72051M63	5G25	11,9x48,6	1200	1620	4
03050E72041M64	4G35	13,5x44	1344	1690	2
03050E72041M65	4G50	16x54	1920	2450	1
03050E72041M66	4G70	18,5x61	2688	3400	2/0
03050E72041M67	4G95	20,5x69,5	3684	4550	3/0

Other dimensions and colors available on request.

FLEXIFESTOON® PV-FLAT CY (VCVH6-F)

ELETTROTEK KABEL® FLEXIFESTOON® PV-FLAT CY (VCVH6-F)



Construction:

- Conductor:** flexible red copper conductor Cl. 5, acc to IEC 60228, DIN VDE 0295
- Insulation:** PVC type T12
- Cores color:** acc. to DIN VDE 0293-308, HD 308 S2 from 6 cores black cores with consecutive numbers acc. to EN 50334; green-yellow earth-wire from 3 cores
- Stranding:** cores laying parallel
- Screen:** red copper braid
- Outer sheath:** black (similar to RAL 9005), special PVC compound

Resistance:



Self-extinguishing and flame retardant acc. to:
DIN VDE 0482 part 265-2-1
EN 50265-2-1
IEC 60332-1-2



Oil resistance acc. to:
DIN VDE 0473 part 811-2-1
IEC EN 60811-2-1

Technical data:

- Nominal voltage:**
up to 1,5 mm²: U₀/U 300/500 V
from 2,5 mm²: U₀/U 0,6/1 kV
- Test voltage:**
up to 1,5 mm²: 2 kV
from 2,5 mm²: 2,5 kV
- Temperature range:**
Fixed laying: -25°C up to +60°C
Flexible application: -20°C up to +60°C
- Max. temp on conductor:**
In service: up to +70°C
In short circuit: up to +150°C
- Min. bending radius:** 10 x D
- Radiation resistance:** up to 80x10⁶ cJ/kg (up to 80 Mrad)
- Tensile strength:**
Static: 15 n/mm²
Dynamic: 30 n/mm²
- Max speed (main application):** 120 m/min

Features:

- UV, ozone and chemical resistant
- on request tinned copper braid screen
- high flexibility
- minimum waste of space
- for SPEEDS and MINIMUM BENDING RADIUS see pages from 2 to 8 of catalogue
- RoHS and CE approval



Part no.	No. of cores x cross section n x mm ²	Outer-Ø ca.mm ± 10%	Copper weight kg/km	Cable weight approx. kg/km	AWG no.)*
03060D72051M05	5G0,5	3,4x21	64	92	20
03060D70054M05	5x(4G0,5)C	7,2x37,4	175	280	20
03060D70089900	8x(7G0,5)C	11,7x68,6	480	650	20
03060D70044M10	4x4G1	11x33,5	310	350	18
03060D71160M10	16x1	53,5x5,4	368	630	18
03060D72041M15	4G1,5	5,5x18	114	220	16
03060D70071M15	7G1,5	6,9x21	156	300	16
03060D70081M15	8G1,5	5,5x34	179	430	16
03060D70121M15	12G1,5	5,5x50	267	584	16
03060G72041M25	4G2,5	6x21	133	278	14
03060G72051M25	5G2,5	6x35,9	189,3	396	14
03060G70061M25	6G2,5	6x37,4	205,3	430	14
03060G70071M25	7G2,5	6x48,2	229	475	14
03060G70121M25	12G2,5	6x59	385	550	14
03060G72041M40	4G4	7x23	222	360	12
03060G72041M60	4G6	9x29	313	580	10
03060G72041M61	4G10	11x37	522	900	8
03060G72041M62	4G16	14x46	784	1280	6
03060G72041M63	4G25	14,5x50	1163	1800	4
03060G72041M64	4G35	16x55	1549	2300	2

Other dimensions and colors available on request.

FESTOON CABLES

FLEXIFESTOON® PV-FLAT UL



Construction:

- Conductor:** flexible red copper conductor class M from 16 AWG up to 14 AWG
flexible red copper conductor class K from 12 AWG and larger
- Insulation:** special PVC compound 105°C
- Cores color:** acc. to ICEA Method 1-E2 (K-2)*
*5 conductors:
1 green, 2 white, 3 black, 4 red and blue
- Stranding:** cores laying parallel
- Outer sheath:** yellow (similar to RAL 1021), special PVC compound 105°C
black (similar to RAL 9005), on request

Resistance:



Self-extinguishing and flame retardant acc. to:
UL VW-1, CSA FT4

Technical data:

- Nominal voltage:** 600 V
- Max. operating voltage:** 2000 V
- Test voltage:** 2 kV
- Temperature range:** -40°C up to +105°C
- Max. temp on conductor:**
In service: up to +90°C (105°C)
In short circuit: up to +150°C
- Min. bending radius:** 5 x d
- Max. temp on conductor:**
In service: up to +90°C (105°C)
In short circuit: up to +150°C
- Tensile strenght:**
Static: 15 n/mm²
Dynamic: 30 n/mm²
- Max speed (main application):** 120 m/min

Features:

- oil resistant outer sheath
- UV resistant
- cold resistant
- Indoor/outdoor use
- high flexibility
- minimum waste of space
- acc. to NEC approval
- UL festoon and AWM 105°C 600 V
- CSA festoon 105°C 600 V
- for SPEEDS and MINIMUM BENDING RADIUS see pages from 2 to 8 of catalogue

Part no.	No. of cores x cross section n x AWG	Outer Ø inches/mm ±10%	Copper weight Lbs/Mft - kg/km	Cable weight approx. Lbs/Mft - kg/km
03220FYU040A16	4x16	0,6x0,2 - 15,2x5,1	33,8 - 50,3	87,4 - 130
03220FYU080A16	8x16	1,12x0,2 - 28,5x5,1	67,6 - 100,6	174,7 - 260
03220FYU120A16	12x16	1,68x0,2 - 41x5,1	101,4 - 150,9	268,8 - 400
03220FYU040A14	4x14	0,69x0,24 - 17,5x6,2	53,7 - 79,9	141,1 - 210
03220FYU080A14	8x14	1,34x0,24 - 34x6,2	107,3 - 159,7	255,4 - 380
03220FYU120A14	12x14	1,97x0,24 - 50x6,2	161,3 - 240	362,9 - 540
03220FYU040A12	4x12	0,71x0,24 - 18,1x6	85,4 - 127,1	168 - 250
03220FYU050A12	5x12	0,85x0,22 - 21,5x5,6	106,8 - 158,9	201,6 - 300
03220FYU080A12	8x12	1,34x0,24 - 34x6	170,8 - 254,2	315,8 - 470
03220FYU120A10	4x10	0,89x0,27 - 22,5x6,9	135,7 - 202	255,4 - 380
03220FYU050A10	5x10	1,08x0,27 - 27,5x6,9	169,7 - 252,5	302,4 - 450
03220FYU040A08	4x8	1,2x0,37 - 30,5x9,4	215,2 - 320,2	403,2 - 600
03220FYU040A06	4x6	1,45x0,43 - 36,8x10,9	343 - 510,7	618,2 - 920
03220FYU040A04	4x4	1,68x0,49 - 42,6x12,5	547,1 - 814,1	873,6 - 1300
03220FYU040A02	4x2	1,97x0,57 - 50x14,5	867 - 1290,2	1276,8 - 1900
03220FYU040A1C	4x1/0	2,6x0,75 - 66x19,1	1378 - 2050,6	2221 - 3305
03220FYU040A2C	4x2/0	2,72x0,79 - 69x20	1739,1 - 2588,2	2587,2 - 3850

Other dimensions and colors available on request.

H07RN-F

Rubber Sheathed cable, harmonized type

HAR



Construction:

Conductor:	flexible red copper conductor Cl. 5, acc to IEC 60228, DIN VDE 0295
Insulation:	rubber type EI4 acc. to DIN VDE 0282 part 1
Cores color:	acc. to DIN VDE 0293-308, HD 308 S2 from 6 cores black cores with consecutive numbers acc. to EN 50334; green-yellow earth-wire from 3 cores
Stranding:	in layers
Outer sheath:	black (similar to RAL 9005), rubber PCP type EM2

Technical data:

Nominal voltage:	U ₀ /U 450/750 V
Test voltage:	2,5 kV
Temperature range:	
<i>Fixed laying:</i>	-40°C up to +60°C
<i>Flexible application:</i>	-25°C up to +60°C
Min. bending radius:	acc. to DIN VDE 0298 part 3
Tensile strenght:	15 n/mm ²

Resistance:



Self-extinguishing and flame retardant acc. to:
DIN VDE 0482 part 265-2-1
EN 50265-2-1
IEC 60332-1-2



Ozone resistance to insulation acc. to:
DIN VDE 0472 part 805, test method A
or part 805 A1, test method C

Features:

can be used up to +85°C for fixed protected installations
0,6/1 kV version on request
for MINIMUM BENDING RADIUS see pages from 5 to 8
of catalogue
RoHS and CE approval



FESTOON CABLES

H07RN-F

Rubber Sheathed cable, harmonized type

HAR



Part no.	No. of cores x cross section n x mm ²	Outer-Ø ca.mm ± 10%	Copper weight kg/km	Cable weight approx. kg/km	AWG no.*)
03070E7L010M15	1x1,5	6,4	14	58	16
03070E7L010M25	1x2,5	7,1	24	71	14
03070E7L010M40	1x4	8,1	38	100	12
03070E7L010M60	1x6	8,8	58	130	10
03070E7L010M61	1x10	10,7	96	230	8
03070E7L010M62	1x16	12,1	154	290	6
03070E7L010M63	1x25	14,2	240	420	4
03070E7L010M64	1x35	16,1	336	530	2
03070E7L010M65	1x50	18,5	480	750	1
03070E7L010M66	1x70	20,9	672	960	2/0
03070E7L010M67	1x95	23,4	912	1250	3/0
03070E7L010M68	1x120	24,8	1152	1560	4/0
03070E7L010M69	1x150	28,3	1440	1900	250 MCM
03070E7L010M70	1x185	31	1776	2300	350 MCM
03070E7L010M71	1x240	34,4	2304	2950	450 MCM
03070E7L010M72	1x300	37,7	2880	3600	550 MCM
03070E7L010M73	1x400	42,1	3840	4600	750 MCM
03070E7L010M74	1x500	46,6	4800	6000	1000 MCM
03070E73020M10	2x1	8,8	19	98	18
03070E73020M15	2x1,5	9,2	29	135	16
03070E73020M25	2x2,5	11,6	48	193	14
03070E73020M40	2x4	13,4	77	280	12
03070E73020M60	2x6	15	115	330	10
03070E73020M61	2x10	20,1	192	586	8
03070E73020M62	2x16	23,0	307	810	6
03070E73020M63	2x25	27,5	480	1160	4
03070E72031M10	3G1	9,5	29	130	18
03070E72031M15	3G1,5	10,5	43	165	16
03070E72031M25	3G2,5	12,4	72	235	14
03070E72031M40	3G4	14,4	115	320	12
03070E72031M60	3G6	16	173	420	10
03070E72031M61	3G10	21,6	288	810	8
03070E72031M62	3G16	24,7	461	1050	6
03070E72031M63	3G25	28	720	1250	4
03070E72031M64	3G35	33,2	1008	1900	2
03070E72031M65	3G50	38,5	1440	2600	1
03070E72031M66	3G70	43,3	2016	3400	2/0
03070E72031M67	3G95	48,6	2736	4450	3/0
03070E72031M68	3G120	53,8	3456	5180	4/0

FESTOON CABLES

H07RN-F

Rubber Sheathed cable, harmonized type

HAR



Part no.	No. of cores x cross section n x mm ²	Outer-Ø ca.mm ± 10%	Copper weight kg/km	Cable weight approx. kg/km	AWG no.*)
03070E72031M69	3G150	59	4320	6500	250 MCM
03070E72031M70	3G185	64,6	5328	7860	350 MCM
03070E72031M71	3G240	73,5	6192	10224	450 MCM
03070E72031M72	3G300	81	8640	12620	550 MCM
03070E72041M10	4G1	10,5	38	150	18
03070E72041M15	4G1,5	11,6	58	200	16
03070E72041M25	4G2,5	13,8	96	290	14
03070E72041M40	4G4	16	154	395	12
03070E72041M60	4G6	17,8	230	540	10
03070E72041M61	4G10	23,7	384	800	8
03070E72041M62	4G16	26,9	614	1260	6
03070E72041M63	4G25	32,7	960	1860	4
03070E72041M64	4G35	36,3	1334	2380	2
03070E72041M65	4G50	42,5	1920	3190	1
03070E72041M66	4G70	48,3	2688	4260	2/0
03070E72041M67	4G95	54,7	3638	5600	3/0
03070E72041M68	4G120	59,5	4608	6830	3/0
03070E72041M69	4G150	65,5	5760	8320	250 MCM
03070E72041M70	4G185	72	7104	9800	350 MCM
03070E72041M71	4G240	81,5	9216	12100	450 MCM
03070E72041M72	4G300	90,5	11520	15200	550 MCM
03070E72051M15	5G1,5	12,8	72	240	16
03070E72051M25	5G2,5	15,2	120	345	14
03070E72051M40	5G4	17,7	192	485	12
03070E72051M60	5G6	19,8	288	650	10
03070E72051M61	5G10	26	480	1200	8
03070E72051M62	5G16	29,8	768	1550	6
03070E72051M63	5G25	36,2	1200	2250	4
03070E72051M64	5G35	41,3	1680	2750	2
03070E72051M65	5G50	45,4	2400	3950	1
03070E70071M15	7G1,5	16	101	375	16
03070E70071M25	7G2,5	18	168	520	14
03070E70121M25	12G1,5	20	175	460	16
03070E70121M25	12G2,5	23,4	288	760	14
03070E70181M25	18G2,5	27,6	432	850	14
03070E70191M15	19G1,5	23,5	274	810	16
03070E70191M25	19G2,5	28,2	456	1075	14
03070E70241M15	24G1,5	27,5	346	1015	16
03070E70241M25	24G2,5	32,6	576	1390	14

Other dimensions and colors available on request.

FESTOON CABLES

FLEXIFESTOON® SOOW

EPDM/CPE cable, UL 600 V -40°C up to 90°C - CSA SOOW 600 V -40°C up to +90°C FT2 Water resistant, MSHA



ELETTROTEKKABEL® FLEXIFESTOON® SOOW
UL 600 V -40°C up to 90°C - CSA SOOW 600 V
-40°C up to 90°C FT2 Water resistant, MSHA



Construction:

Conductor:	finely stranded red copper acc.to Cl. K, acc. to ASTM B-174
Insulation:	rubber EPDM compound
Cores color:	acc. to ICEA Method 1-E1 (K-1)
Stranding:	in layers
Outer sheath:	black (similar to RAL 9005), rubber CPE compound

Resistance:



Flame test acc. to:
CSA FT 2

Technical data:

Nominal voltage:	600 V
Test voltage:	2 kV
Temperature range:	
<i>Fixed laying:</i>	-40°C up to +90°C
<i>Flexible application:</i>	-40°C up to +90°C
Min. bending radius:	
<i>Fixed laying:</i>	4 x D
<i>Flexible application:</i>	4 x D

Features:

UV, ozone, water, oil and abrasion resistant

flexible in cold weather

on request tinned copper conductor

on request screened version

(UL) 600 V -40°C up to 90°C
CSA 600 V -40°C up to 90°C FT2

acc. to UL standard 62

acc. to CSA 22.2 No. 49

acc. to NEC 501.140 Class 1 div. 2

acc. to NEC Article 400

MSHA approval

for MINIMUM BENDING RADIUS see pages from 5 to 8 of catalogue

RoHS approval



FESTOON CABLES

FLEXIFESTOON® SOOW

EPDM/CPE cable, UL 600 V -40°C up to 90°C - CSA SOOW 600 V -40°C up to +90°C FT2 Water resistant, MSHA



ELETTROTEKKABEL® FLEXIFESTOON® SOOW
UL 600 V -40°C up to 90°C - CSA SOOW 600 V
-40°C up to 90°C FT2 Water resistant, MSHA



Part no.	No. of cores x cross section n x AWG	Outer-Ø inches/mm ± 10%	Cable weight approx. Lbs/Mft-kg/km	Current capacity at +30°C Amps
03200F7K020A18	2 x 18	0,346 - 7,6	67 - 100	10
03200F7K030A18	3 x 18	0,365 - 9,27	84 - 125	10
03200F7K040A18	4 x 18	0,39 - 9,91	98 - 146	7
03200F7K050A18	5 x 18	0,465 - 11,81	116 - 173	5
03200F7K020A16	2 x 16	0,37 - 9,4	81 - 121	13
03200F7K030A16	3 x 16	0,39 - 9,91	94 - 140	13
03200F7K040A16	4 x 16	0,415 - 10,54	118 - 176	10
03200F7K050A16	5 x 16	0,495 - 12,57	143 - 213	8
03200F7K080A16	8 x 16	0,575 - 14,6	222 - 331	-
03200F7K100A16	10 x 16	0,62 - 15,8	278 - 414	-
03200F7K120A16	12 x 16	0,66 - 16,8	305 - 454	-
03200F7K020A14	2 x 14	0,5 - 12,7	134 - 199	18
03200F7K030A14	3 x 14	0,525 - 13,34	169 - 252	18
03200F7K040A14	4 x 14	0,57 - 14,48	201 - 299	15
03200F7K050A14	5 x 14	0,668 - 16,97	272 - 405	12
03200F7K080A14	8 x 14	0,74 - 18,9	324 - 480	32
03200F7K020A12	2 x 12	0,57 - 14,48	184 - 274	25
03200F7K030A12	3 x 12	0,595 - 15,11	224 - 333	25
03200F7K040A12	4 x 12	0,650 - 16,51	276 - 411	20
03200F7K050A12	5 x 12	0,713 - 18,11	318 - 473	16
03200F7K080A12	8 x 12	0,80 - 20,2	408 - 607	14
03200F7K200A12	20 x 12	1,22 - 31	971 - 1445	10
03200F7K020A10	2 x 10	0,615 - 15,62	225 - 335	30
03200F7K030A10	3 x 10	0,66 - 16,76	299 - 445	30
03200F7K040A10	4 x 10	0,71 - 18,03	360 - 536	25
03200F7K050A10	5 x 10	0,77 - 19,56	409 - 609	20
03200F7K030A08	3 x 8	0,88 - 22,35	485 - 722	40
03200F7K040A08	4 x 8	0,953 - 24,21	619 - 921	35
03200F7K050A08	5 x 8	1,034 - 26,26	722 - 1074	28
03200F7K030A06	3 x 6	1,04 - 26,42	700 - 1042	55
03200F7K040A06	4 x 6	1,125 - 28,58	837 - 1246	45
03200F7K050A06	5 x 6	1,185 - 30,1	979 - 1457	36
03200F7K030A04	3 x 4	1,315 - 28,83	902 - 1342	70
03200F7K040A04	4 x 4	1,255 - 31,88	1144 - 1702	60
03200F7K050A04	5 x 4	1,348 - 34,24	1320 - 1964	48
03200F7K020A02	3 x 2	1,305 - 33,15	1277 - 1900	95
03200F7K040A02	4 x 2	1,455 - 36,96	1639 - 2439	80
03200F7K050A02	5 x 2	1,556 - 39,52	1925 - 2439	64

Other dimensions and colors available on request.

FESTOON CABLES

FLEXIFESTOON® SEOOOW YELLOW

TPE/TPE cable, UL 600 V -60°C up to 105°C - CSA SEOOOW 600 V -60°C up to +105°C FT2 Water resistant, MSHA



ELETTROTEKKABEL® FLEXIFESTOON® SEOOOW YELLOW
UL 600 V -60°C up to 105°C - CSA SEOOOW 600 V
-60°C up to 105°C FT2 Water resistant, MSHA



Construction:

Conductor:	finely stranded red copper acc.to Cl. K, acc. to ASTM B-174
Insulation:	TPE compound
Cores color:	acc. to ICEA Method 1-E1 (K-1)
Stranding:	in layers
Outer sheath:	yellow (similar to RAL 1021), TPE compound

Resistance:



Flame test acc. to:
CSA FT 2

Technical data:

Nominal voltage:	600 V
Test voltage:	2 kV
Temperature range:	
<i>Fixed laying:</i>	-60°C up to +105°C
<i>Flexible application:</i>	-60°C up to +105°C
Min. bending radius:	
<i>Fixed laying:</i>	4 x D
<i>Flexible application:</i>	4 x D

Features:

UV, ozone, water, oil and abrasion resistant
flexible in cold weather
on request tinned copper conductor
on request screened version

(UL) 600 V -50°C up to 105°C
CSA 600 V -50°C up to 105°C FT2

acc. to UL standard 62

acc. to CSA 22.2 No. 49

acc. to NEC 501.140 Class 1 div. 2

acc. to NEC Article 400

acc. to Federal Spec JC580

acc. to EPA 40 CFR part 26-C,

heavy metals per table 1, TCLP method

MSHA approval

for MINIMUM BENDING RADIUS see pages from 5 to 8 of catalogue

RoHS approval



Part no.	No. of cores x cross section n x AWG	Outer-Ø inches/mm ± 10%	Cable weight approx. Lbs/Mft-kg/km	Current capacity at +30°C Amps
03210FYK020A18	2 x 18	0,342 - 8,69	53 - 79	10
03210FYK030A18	3 x 18	0,362 - 9,19	63 - 94	10
03210FYK040A18	4 x 18	0,387 - 9,83	79 - 118	7
03210FYK020A16	2 x 16	0,367 - 9,32	64 - 95	13
03210FYK030A16	3 x 16	0,387 - 9,83	78 - 116	13
03210FYK040A16	4 x 16	0,412 - 10,46	93 - 138	10
03210FYK020A14	2 x 14	0,497 - 12,62	115 - 171	18
03210FYK030A14	3 x 14	0,522 - 13,26	138 - 205	18
03210FYK040A14	4 x 14	0,562 - 14,27	166 - 247	15
03210FYK020A12	2 x 12	0,567 - 14,4	151 - 225	25
03210FYK030A12	3 x 12	0,595 - 15,11	185 - 275	25
03210FYK040A12	4 x 12	0,642 - 16,31	227 - 338	20
03210FYK020A10	2 x 10	0,617 - 15,67	192 - 286	30
03210FYK030A10	3 x 10	0,652 - 16,56	244 - 363	30
03210FYK040A10	4 x 10	0,702 - 17,83	300 - 446	25

Other dimensions and colors available on request.

FLEXIFESTOON® H07BN4-F

HAR



Construction:

Conductor:	flexible red copper conductor Cl. 5, acc to IEC 60228, DIN VDE 0295
Insulation:	rubber EPR type E17 acc. to DIN VDE 0282 part 1
Cores color:	acc. to DIN VDE 0293-308, HD 308 S2 from 6 cores black cores with consecutive numbers acc. to EN 50334; green-yellow earth-wire from 3 cores
Outer sheath:	black (similar to RAL 9005), rubber EPR type EM7

Resistance:



Self-extinguishing and flame retardant acc. to:
DIN VDE 0482 part 265-2-1
EN 50265-2-1
IEC 60332-1-2

Technical data:

Nominal voltage:	U ₀ /U 450/750 V			
Test voltage:	3 kV			
Temperature range:	-45°C up to +90°C			
Max short circuit temperature:	+ 250°C			
Min. bending radius:				
Fixed laying:	acc. to CEI 20-20/20-19			
	D≤8	8<D≤12	12<D≤20	D>20
<i>normal use:</i>	4 x D	5 x D	6 x D	6 x D
<i>accurate bending close to the terminal:</i>	2 x D	3 x D	4 x D	4 x D
Flexible application:	acc. to CEI 20-20			
<i>fixed lay:</i>	3 x D	3 x D	4 x D	4 x D
<i>free move:</i>	4 x D	4 x D	5 x D	6 x D
<i>at the entrance to a portable device or a mobile equipment:</i>				
- without cable stressing:	4 x D	4 x D	5 x D	6 x D
- without mechanical stress:	6 x D	6 x D	6 x D	8 x D
<i>festoon i.e. for support crane:</i>	6 x D	6 x D	6 x D	8 x D
<i>repeated winding:</i>	6 x D	6 x D	6 x D	8 x D
<i>turned off on pulley:</i>	8 x D	8 x D	8 x D	8 x D
Max. torsion:	+/- 150°/1 m			

Features:

UV resistant
on request tinned copper conductors
acc. to CENELEC HD 22.2 , CEI 20-19
acc. to CEI 20-19/12, CEI 20-35, CENELEC HD 21.12 S1
for MINIMUM BENDING RADIUS see pages from 5 to 8 of catalogue
RoHS and CE approval



FESTOON CABLES

FLEXIFESTOON® H07BN4-F

HAR



Part no.	No. of cores x cross section n x mm ²	Outer-Ø ca.mm ± 10%	Copper weight kg/km	Cable weight approx. kg/km	AWG no.*)
03080E7L010M15	1x1,5	5,9	14,4	50	16
03080E7L010M25	1x2,5	6,5	24	65	14
03080E7L010M40	1x4	7,4	38,4	89	12
03080E7L010M60	1x6	8,1	57,6	115	10
03080E7L010M61	1x10	10,4	96	190	8
03080E7L010M62	1x16	11,6	153,6	259	6
03080E7L010M63	1x25	13,7	240	375	4
03080E7L010M64	1x35	15,3	336	492	2
03080E7L010M65	1x50	17,7	480	675	1
03080E7L010M66	1x70	20	672	908	2/0
03080E7L010M67	1x95	22,1	912	1171	3/0
03080E7L010M68	1x120	24,5	1152	1445	4/0
03080E7L010M69	1x150	26,9	1440	1783	250 MCM
03080E7L010M70	1x185	28,9	1776	2125	350 MCM
03080E7L010M71	1x240	32,6	2304	2733	450 MCM
03080E7L010M72	1x300	36,7	2880	3348	550 MCM
03080E7L010M73	1x400	39,9	3840	4327	750 MCM
03080E7L010M74	1x500	45,8	4800	5450	950 MCM
03080E7L010M75	1x630	54	6048	6900	1200 MCM

Other dimensions and colors available on request.

FESTOON CABLES

FLEXIFESTOON® DLO



ELETTROTEK KABEL® FLEXIFESTOON® DLO

Construction:

Conductor:	annealed stranded tinned copper, acc. to ASTM B-33, AAR-598
Insulation:	special EPR compound
Core color:	black
Stranding:	in layers
Outer sheath:	black (similar to RAL 9005), special rubber CPE compound

Resistance:



Flame test acc. to:
FT4, FT1, UL VW-1

Technical data:

Nominal voltage:	U ₀ /U DLO 2000 V
Test voltage:	4 kV
Temperature range:	-40°C up to +90°C
Min. bending radius:	
<i>Fixed laying:</i>	4 x D
<i>Flexible application:</i>	6 x D

Features:

UV, wet, oils and chemical resistant

**UL: 90°C, 600 V for CT use, VW-1 CSA RW 90°C
DRY/WET 600 V -40°C FT1, MSHA DLO Type 2000 V**

UL44 Type RHH/RHW-2,

1000 V CSA Type RW-90

ICEA S-95-685/ NEMA WC 70

90°C WET/DRY for continuous exposure

approved for CT use

for MINIMUM BENDING RADIUS see pages from 5 to 8 of catalogue

RoHS approval



Part no.	No. of cores x cross section n x AWG	Outer-Ø inches/mm ± 10%	Cable weight approx. Lbs/Mft-kg/km	Current capacity at +30°C Amps
0325017L010A08	1x8	0,348-8,84	105-156	80
0325017L010A06	1x6	0,386-9,8	146-217	105
0325017L010A04	1x4	0,438-11,1	206-307	140
0325017L010A02	1x2	0,500-12,7	293-436	190
0325017L010A01	1x1	0,613-15,6	392-584	220
0325017L010A1C	1x1/0	0,620-15,8	462-688	260
0325017L010A2C	1x2/0	0,680-17,3	558-830	300
0325017L010A3C	1x3/0	0,752-19,1	673-1003	350
0325017L010A4C	1x4/0	0,780-19,8	833-1240	405
0325017L010A5C	1x262	0,920-23,4	1077-1603	467
0325017L010A6C	1x313	0,968-24,6	1225-1823	518
0325017L010A7C	1x373	1,065-27	1485-2210	588
0325017L010A9C	1x444	1,132-28,8	1913-2847	649
0325017L010ABC	1x535	1,240-31,5	2023-3010	7L5
0325017L010ADC	1x646	1,359-34,5	2515-3742	814
0325017L010AFC	1x777	1,382-35,1	3050-4538	900

Other dimensions and colors available on request.

FLEXIFESTOON® (N)GRDGÖU-J

Flexible round festoon cable acc. to VDE 0250 part 813 as far as applicable

ELETTROTEK KABEL® FLEXIFESTOON® (N)GRDGÖU-J



Substrate for festoon application

Construction:

Conductor:	flexible red copper conductor Cl. 5, acc to IEC 60228, DIN VDE 0295
Insulation:	rubber EPR type 3GI3 acc. to DIN VDE 0207
Bus cores and twisted pair screen:	synthetic tapes and tinned copper wires braid screen
Cores color:	acc. to DIN VDE 0293-308, HD 308 S2 from 6 cores white cores with consecutive numbers acc. to EN 50334; green-yellow earth-wire from 3 cores
Stranding:	in layers
Inner sheath	rubber EPR type GM1b, acc. to DIN VDE 0207 part 21
Outer sheath:	black (similar to RAL 9005), rubber PCP type 5GM3, acc. to DIN VDE 0207 part 21

Resistance:



Self-extinguishing and flame retardant acc. to:
DIN VDE 0482 part 265-2-1
EN 50265-2-1
IEC 60332-1-2



Oil resistance acc. to:
DIN VDE 0473 part 811-2-1
IEC EN 60811-2-1

Technical data:

Nominal voltage:	U _o /U 0,6/1 kV
Max. operating voltage in A.C. systems:	U _o /U 0,7/1,2 kV
Max. operating voltage in D.C. systems:	U _o /U 0,9/1,8 kV
Test voltage A.C.:	
Power cores:	3,5 kV
Control cores:	2,5 kV
Temperature range:	
Fixed laying:	-50°C up to +80°C
Flexible application:	-35°C up to +80°C
Max. temp on conductor:	
In service:	up to +90°C
In short circuit:	up to +250°C
Min. bending radius:	acc. to DIN VDE 0298 part 3
Tensile strenght:	
Static:	15 n/mm ²
Dynamic:	30 n/mm ²
Max. torsion:	± 25°/1mt.
Max speed (main application):	240 m/min

Features:

UV, ozone, moisture and water resistant

outdoor use

On request:

Marking UL 600 V or MSHA identified with "5" on the 5th number of the Part. no

GOST-R approval on request

for SPEEDS and MINIMUM BENDING RADIUS see pages from 2 to 8 of catalogue

RoHS and CE approval



Applications:

flexible power and control cable using for FESTOON SYSTEMS, cranes equipment, etc.

FESTOON CABLES

FLEXIFESTOON® (N)GRDGÖU-J

Flexible round festoon cable acc. to VDE 0250 part 813 as far as applicable

ELETTROTEK KABEL® FLEXIFESTOON® (N)GRDGÖU-J



Suitable for festoon application

POWER:

Part no.	No. of cores x cross section n x mm ²	Outer-Ø ca.mm ± 10%	Copper weight kg/km	Cable weight approx. kg/km	Tensile strength N	AWG no.®)
03090G7L010M63	1x25	11,5	240	325	375	4
03090G7L010M64	1x35	13,3	336	420	525	2
03090G7L010M65	1x50	16,6	480	620	750	1
03090G7L010M66	1x70	17,9	672	825	1050	2/0
03090G7L010M67	1x95	19,8	912	1060	1425	3/0
03090G7L010M68	1x120	22,1	1152	1337	1800	4/0
03090G7L010M69	1x150	24,4	1440	1642	2250	250 MCM
03090G7L010M70	1x185	26,8	1776	2004	2775	350 MCM
03090G72037M64	3x35+3G16/3	29,5	1161,6	1795	1575	2
03090G72037M65	3x50+3G25/3	34,5	1680	2535	2250	1
03090G72037M66	3x70+3G35/3	40,8	2352	3560	3150	2/0
03090G72037M66	3x95+3G50/3	42,5 max.	3216	4493	4275	3/0
03090G72041M40	4G4	14,9	153,6	330	240	12
03090G72041M60	4G6	17,1	230,4	468	360	10
03090G72041M61	4G10	19,4	360	685	600	8
03090G72041M62	4G16	24,1	614,4	1055	960	6
03090G72041M63	4G25	28,6	960	1595	1500	4
03090G72041M64	4G35	31,8	1344	2080	2100	2
03090G72041M65	4G50	37,5	1920	2960	3000	1
03090G72051M40	5G4	17	192	440	300	12
03090G72051M60	5G6	18,8	288	565	450	10
03090G72051M61	5G10	22,1	480	865	750	8
03090G72051M62	5G16	26,5	768	1287	1200	6
03090G72051M63	5G25	31,5 max.	1200	1990	1900	4

CONTROL:

Part no.	No. of cores x cross section n x mm ²	Outer-Ø ca.mm ± 10%	Copper weight kg/km	Cable weight approx. kg/km	Tensile strength N	AWG no.®)
03090G7A121M15	12G1,5	17,5	172,8	435	270	16
03090G7A181M15	18G1,5	20	388,8	610	405	16
03090G7A241M15	24G1,5	23,4	345,6	808	540	16
03090G7A301M15	30G1,5	24,7	432	936	675	16
03090G7A361M15	36G1,5	26,4	518,4	1080	810	16
03090G7A041M25	4G2,5	15,8	96	367	150	14
03090G7A071M25	7G2,5	19,8	168	600	262	14
03090G7A121M25	12G2,5	19,1	288	585	450	14
03090G7A181M25	18G2,5	22,8	432	872	650	14
03090G7A241M25	24G2,5	26	576	1100	900	14
03090G7A301M25	30G2,5	28,1	720	1345	1125	14
03090G7A361M25	36G2,5	30,2	864	1560	1350	14

BUS (TWISTED PAIRS SCREENED):

Part no.	No. of cores/pairs x cross section n x mm ²	Outer-Ø ca.mm ± 10%	Cable weight approx. kg/km	Tensile strength N	AWG no.®)
03090G7C032M10	3x(2x1)C	19,5	675	90	18
03090G7C062M05	6x(2x0,5)C	20,5	840	180	20
03090G7C062M10	6x(2x1)C	27	1260	180	18
03090G7C092M05	9x(2x0,5)C	27,5	1348	270	20
03090G7C092M10	9x(2x1)C	34	2002	270	18
03090G7C122M05	12x(2x0,5)C	28,5	1536	360	20
03100G7C120M10	(12x1)C	17	578	180	18

Other dimensions and colors available on request.

FLEXIFESTOON® (N)GRDGCGÖU-J

Flexible screened round festoon cable

ELETTROTEK KABEL® FLEXIFESTOON® (N)GRDGCGÖU-J



Construction:

Conductor:	flexible red copper conductor Cl. 5, acc to IEC 60228, DIN VDE 0295
Insulation:	rubber EPR type 3GI3 acc. to DIN VDE 0207
Cores color:	acc. to DIN VDE 0293-308, HD 308 S2 3 conductors + 3 earth conductors: grey, brown, black and green/yellow divided in interstices 4 cores: green/yellow, brown, black, grey
Stranding:	in layers with short lay-length
Inner sheath	rubber EPR type GM1b
Screen:	tinned copper braid
Outer sheath:	black (similar to RAL 9005), rubber PCP type 5GM3, acc. to DIN VDE 0207 part 21

Resistance:



Self-extinguishing and flame retardant acc. to:
DIN VDE 0482 part 265-2-1
EN 50265-2-1
IEC 60332-1-2



Oil resistance acc. to:
DIN VDE 0473 part 811-2-1
IEC EN 60811-2-1

Technical data:

Nominal voltage:	U _o /U 0,6/1 kV
Max. operating voltage in A.C. systems:	U _o /U 0,7/1,2 kV
Max. operating voltage in D.C. systems:	U _o /U 0,9/1,8 kV
Test voltage A.C.:	3,5 kV
Temperature range:	
<i>Fixed laying:</i>	-50°C up to +80°C
<i>Flexible application:</i>	-35°C up to +80°C
Max. temp on conductor:	
<i>In service:</i>	up to +90°C
<i>In short circuit:</i>	up to +250°C
Min. bending radius:	acc. to DIN VDE 0298 part 3
Tensile strenght:	
<i>Static:</i>	15 n/mm ²
<i>Dynamic:</i>	30 n/mm ²
Max speed (main application):	240 m/min

Features:

UV, ozone, moisture and water resistant
outdoor use
acc. to DIN VDE 0250 part 814
good EMC characteristics
On request:
Marking UL 600 V or MSHA
identified with "5" on the 5th number of the Part. no
GOST-R and WUG approval on request
for SPEEDS and MINIMUM BENDING RADIUS
see pages from 2 to 8 of catalogue
RoHS and CE approval



Applications:

used in FESTOON SYSTEMS,
for motor power supply cables

FLEXIFESTOON® (N)GRDGCGÖU-J

Flexible screened round festoon cable

ELETTROTEK KABEL® FLEXIFESTOON® (N)GRDGCGÖU-J



Suitable for festoon application

Part no.	No. of cores x cross section n x mm ²	Outer-Ø ca.mm ± 10%	Cable weight approx. kg/km	Tensile strength N	AWG no.*)
03100G7L010M68	1x120	22,5	1320	1800	4/0
03100G72041M40	4G4	16,6	475	240	12
03100G72041M60	4G6	19,2	710	300	10
03100G72041M61	4G10	21,5	915	600	8
03100G72051M61	5G10	24	1080	-	8
03100G72051M62	5G16	28	1530	-	6
03100G72037M62	3x16+3G2,5	24	1145	720	6
03100G72037M63	3x25+3G4	27,2	1615	1125	4
03100G72037M64	3x35+3G6	31,2	2150	1575	2
03100G72037M65	3x50+3G10	36,8	3101	2250	1
03100G72037M66	3x70+3G10	42,7	4105	3150	2/0
03100G72037M67	3x95+3G16	45,9	5030	4275	3/0
03100G72037M68	3x120+3G16	50,6	5890	5400	4/0

Other dimensions and colors available on request.

FLEXIFESTOON® PUR

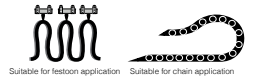

Construction:

Conductor:	flexible red copper conductor Cl. 5, acc to IEC 60228, DIN VDE 0295
Insulation:	special TPE compound
Cores color:	acc. to DIN VDE 0293-308, HD 308 S2 from 6 cores black cores with consecutive numbers acc. to EN 50334; green-yellow earth-wire from 3 cores
Central unit:	textile elements
Stranding:	in layers around central unit
Wrapping:	non woven tape
Outer sheath:	black (similar to RAL 9005), PUR compound

Technical data:

Nominal voltage:	U ₀ /U 0,6/1 kV
Test voltage:	4 kV
Temperature range:	
<i>Fixed laying:</i>	-50°C up to +90°C
<i>Flexible application:</i>	-40°C up to +90°C
Max. temp on conductor:	
<i>In service:</i>	up to +90°C
<i>In short circuit:</i>	up to +250°C
Min. bending radius:	6 x D
Tensile strenght:	up to 15 n/mm ²
Max speed (main application):	240 m/min

Resistance:



Self-extinguishing and flame retardant acc. to:
DIN VDE 0482 part 265-2-1
EN 50265-2-1
IEC 60332-1-2



Halogen-free acc. to:
DIN VDE 0482 part 267,
EN 50267-2-1,
IEC 60754-1

Features:

UV, oil, and chemical resistance
small outer diameter
reduced cable weight
high mechanicla resistance
for SPEEDS and MINIMUM BENDING RADIUS
see pages from 2 to 8 of catalogue
RoHS and CE approval



Applications:

FLEXIFESTOON® PUR is used as energy and control cable at very high mechanical stresses. For FESTOON SYSTEMS, and machine tools or conveying systems. Possible drum reeling cable use.

FESTOON CABLES

FLEXIFESTOON® PUR

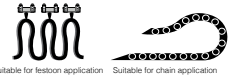

ELETTROTEK KABEL® FLEXIFESTOON® PUR

Part no.	No. of cores x cross section n x mm ²	Outer-Ø ca.mm ± 10%	Copper weight kg/km	Cable weight approx. kg/km	AWG no.*)
03110G7L010M62	1x16	8,7	153,6	179	6
03110G7L010M63	1x25	10,5	240	272	4
03110G7L010M64	1x35	12,1	226	377	2
03110G7L010M65	1x50	13,5	480	534	1
03110G7L010M66	1x70	15,8	672	712	2/0
03110G7L010M67	1x95	18,7	912	990	3/0
03110G7L010M68	1x120	20,4	1152	1187	4/0
03110G7L010M69	1x150	22,3	1440	1482	250 MCM
03110G7L010M70	1x185	24	1776	1781	350 MCM
03110G7L010M71	1x240	28,1	2304	2412	450 MCM
03110G72031M15	3G1,5	7,3	43,2	76	16
03110G72041M15	4G1,5	7,9	57,6	94	16
03110G72051M15	5G1,5	8,6	72	116	16
03110G70071M15	7G1,5	10,2	100,8	167	16
03110G70121M15	12G1,5	12,6	172,8	246	16
03110G70181M15	18G1,5	15	259,2	369	16
03110G70241M15	24G1,5	17,7	345,6	477	16
03110G70301M15	30G1,5	18,9	432	583	16
03110G72031M25	3G2,5	8,3	72	109	14
03110G72041M25	4G2,5	9,3	96	140	14
03110G72051M25	5G2,5	10,1	120	174	14
03110G70071M25	7G2,5	12,1	168	251	14
03110G70121M25	12G2,5	15,0	288	379	14
03110G70181M25	18G2,5	17,5	432	557	14
03110G70241M25	24G2,5	21,1	576	732	14
03110G70301M25	30G2,5	22,3	720	889	14
03110G72041M40	4G4	10,9	153,6	208	12
03110G72041M60	4G6	12,8	230,4	301	10
03110G72041M61	4G10	16,5	384	497	8
03110G72041M62	4G16	20,7	614,4	769	6
03110G72041M63	4G25	24,3	960	1125	4
03110G72041M64	4G35	28,5	1344	1585	2
03110G72041M65	4G50	32,1	1920	2232	1
03110G72051M61	5G10	18,2	480	616	8
03110G72051M62	5G16	23,1	768	980	6
03110G72051M63	5G25	27,1	1200	1434	4

Other dimensions and colors available on request.

FLEXIFESTOON® C PUR



ELETTROTEK KABEL® FLEXIFESTOON® C PUR

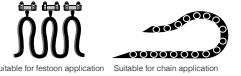

Construction:

Conductor:	flexible red copper conductor Cl. 5, acc to IEC 60228, DIN VDE 0295
Insulation:	special TPE compound
Cores color:	acc. to DIN VDE 0293-308, HD 308 S2 3 conductors + 3 earth conductors: grey, brown, black and green/yellow divided in interstices 4 cores: green/yellow, brown, black, grey
Central unit:	textile elements
Stranding:	in layers around central unit
Screen:	tinned copper braid
Outer sheath:	black (similar to RAL 9005), PUR compound

Technical data:

Nominal voltage:	U _o /U 0,6/1 kV
Test voltage:	4 kV
Temperature range:	
<i>Fixed laying:</i>	-50°C up to +90°C
<i>Flexible application:</i>	-40°C up to +90°C
Max. temp on conductor:	
<i>In service:</i>	up to +90°C
<i>In short circuit:</i>	up to +250°C
Min. bending radius:	6 x D
Tensile strenght:	up to 15 n/mm ²
Max speed (main application):	240 m/min

Resistance:



Self-extinguishing and flame retardant acc. to:
DIN VDE 0482 part 265-2-1
EN 50265-2-1
IEC 60332-1-2



Halogen-free acc. to:
DIN VDE 0482 part 267,
EN 50267-2-1,
IEC 60754-1

Features:

UV, oil, and chemical resistance
small outer diameter
reduced cable weight
high mechanicla resistance
for SPEEDS and MINIMUM BENDING RADIUS
see pages from 2 to 8 of catalogue

RoHS and CE approval



Applications:

FLEXIFESTOON® C PUR
is used as energy and control cable at very high mechanical stresses.
For FESTOON SYSTEMS, and machine tools or conveying systems.
Possible drum reeling cable use.

FESTOON CABLES

FLEXIFESTOON® C PUR



ELETTROTEK KABEL® FLEXIFESTOON® C PUR

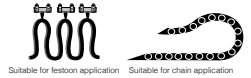

Part no.	No. of cores x cross section n x mm ²	Outer-Ø ca.mm ± 10%	Copper weight kg/km	Cable weight approx. kg/km	Tensile strength N	AWG no.*)
03120G72041M40	4G4	14	221	340	240	12
03120G72041M60	4G6	15,2	300	430	360	10
03120G72041M61	4G10	18,5	454	640	600	8
03120G72041M62	4G16	22	694	1070	960	6
03120G72041M63	4G25	25,5	1050	1520	1500	4
03120G72041M64	4G35	30	1444	2037	2100	2
03120G72041M65	4G50	35	2124	2780	3000	1
03120G70081M25	8G2,5	13	254,4	342	300	14
03120G72037M40	3x4+3G4/3	12,6	212	269	240	12
03120G72037M60	3x6+3G6/3	14,7	297,6	376	360	10
03120G72037M61	3x10+3G10/3	18,5	495,5	631	600	8
03120G72037M62	3x16+3G16/3	21,7	747,8	922	960	6
03120G72037M63	3x25+3G16/3	23,4	1026	1182	1500	4
03120G72037M64	3x35+3G16/3	26,8	1326	1528	2500	2
03120G72037M65	3x50+3G25/3	30	1874,4	2146	3000	1
03120G72037M66	3x70+3G10	35,8	2581,4	2901	4000	2/0

Other dimensions and colors available on request.

PENDANT CABLE

LIFT-2S

ELETTROTEK KABEL® LIFT-2S



Construction:

Conductor:	flexible red copper conductor Cl. 6, acc to IEC 60228, DIN VDE 0295
Insulation:	special PVC compound
Cores color:	white or black cores with consecutive numbers green-yellow earth-wire from 3 cores
Stranding:	in layers
Supporting unit:	two galvanized steel cores, laying parallel with the cable
Outer sheath:	black (similar to RAL 9005), special PVC compound

Resistance:



Self-extinguishing and flame retardant acc. to:
DIN VDE 0482 part 265-2-1
EN 50265-2-1
IEC 60332-1-2

Technical data:

Nominal voltage:	U ₀ /U 300/500 V
Test voltage:	2,5 kV
Temperature range:	
<i>Fixed laying:</i>	-40°C up to +70°C
<i>Flexible application:</i>	-25°C up to +60°C
Max. temp on conductor:	
<i>In service:</i>	up to +90°C
<i>In short circuit:</i>	up to +250°C
Min. bending radius:	10 x D
Max. suspension length:	50 mt.

Features:

UV, ozone and moisture resistance
low abrasion
high notch resistant
RoHS and CE approval



Part no.	No. of cores x cross section n x mm ²	Outer-Ø ca.mm ± 10%	Copper weight kg/km	Cable weight approx. kg/km	Tensile strength N	AWG no. *)
03160D7A061M10	6G1	12	57,6	105	1000	18
03160D7A121M10	12G1	14,9	115,2	210	1000	18
03160D7A181M10	18G1	17,1	172,8	312	1000	18
03160D7A251M10	25G1	21	240	432	1000	18
03160D7A301M10	30G1	21,9	288	520	1000	18
03160D7A081M15	8G1,5	14,9	115	300	1000	16
03160D7A121M15	12G1,5	16,5	172,8	350	1000	16
03160D7A151M15	15G1,5	18,6	230	390	1000	16
03160D7A161M15	16G1,5	18,9	235	440	1000	16
03160D7A181M15	18G1,5	19,3	259	468	1000	16
03160D7A201M15	20G1,5	21	288	520	1000	16
03160D7A241M15	24G1,5	22,6	346	624	1000	16
03160D7A301M15	30G1,5	24	432	700	1000	16

Other dimensions and colors available on request.

PENDANT CABLE

LIFT- IS UL



ELETTROTEK KABEL® LIFT IS UL
UL subject 2562 for pendant cable,
UL 105°C 600 V, CSA AWM I/II A/B 105°C 600 V

Construction:

Conductor:	finely stranded red copper acc.to ASTM B-3 or ASTM B-174
Insulation:	PVC compound 105°C acc. to UL 62, CSA C22.2 No.210.2
Cores color:	acc. to ICEA Method 1-E1 (K-1)
Stranding:	in layer with fibrillated polypropylene filler
Wrapping:	polyester tape
Supporting unit:	one galvanized steel core + black nylon covering, laying parallel with the cable
Outer sheath:	black (similar to RAL 9005), PVC compound acc. to UL 62, CSA C22.2 No.210.2

Resistance:



Self-extinguishing and flame retardant acc. to:

DIN VDE 0482 part 265-2-1
EN 50265-2-1
IEC 60332-1-2
UL type MTW, VW-1,
CSA AWM, FT-1

Technical data:

Nominal voltage:	Uo/U 600 V
Test voltage:	2 kV
Temperature range:	(UL) / c(UL)
<i>Fixed laying:</i>	-25°C up to +105°C
<i>Flexible application:</i>	-25°C up to +105°C
Min. bending radius:	10 x D

Features:

UV, ozone and moisture resistance
low abrasion
high notch resistant
UL subject 2562 for pendant cables
UL 105°C 600 V
CSA AWM I/II A/B 105°C 600 V

Part no.	No. of cores x cross section n x mm ²	Outer-Ø inches/mm ± 10%	Cable weight approx. Lbs/Mft-kg/km	Tensile strength N	AWG no. ³⁾
03170F7K041A16	4 G1,5	0,675 x 0,445 - 17,1 x 11,3	134 - 199,4	1000	16
03170F7K061A16	6 G 1,5	0,75 x 0,52 - 19 x 13,2	171 - 254,4	1000	16
03170F7K081A16	8 G1,5	0,845 x 0,615 - 21,5 x 15,6	213 - 317	1000	16

Other dimensions and colors available on request.

PENDANT CABLE

LIFT-2S UL



Construction:

Conductor:	finely stranded red copper acc.to ASTM B-3 or ASTM B-174
Insulation:	PVC/Nylon special compound
Cores color:	acc. to ICEA Method 1-E2 (K-2)
Central unit:	PVC filler (if necessary)
Stranding:	in layers
Wrapping:	mylar tape
Supporting unit:	two galvanized steel core + black nylon covering, laying parallel with the cable
Outer sheath:	yellow (similar to RAL 1021), PVC compound

Resistance:



Self-extinguishing and flame retardant acc. to:
 DIN VDE 0482 part 265-2-1
 EN 50265-2-1
 IEC 60332-1-2
 UL type MTW, VW-1,
 CSA AWM, FT-1

Technical data:

Nominal voltage:	U ₀ /U 600 V
Test voltage:	2 kV
Temperature range:	(UL) / c(UL)
<i>Fixed laying:</i>	-25°C up to +90°C
<i>Flexible application:</i>	-25°C up to +90°C
Min. bending radius:	10 x D

Features:

UV, ozone and moisture resistance
 low abrasion
 high notch resistant
UL subject 2562 for pendant cables
UL 90°C 600 V
CSA AWM I/II A/B 90°C 600 V

Part no.	No. of cores x cross section n x mm ²	Outer-Ø inches/mm ± 10%	Cable weight approx. Lbs/Mft-kg/km	Tensile strength N	AWG no. ³⁾
03180FYU081A16	8G1,5	0,895 x 0,490 - 22,7 x 12,4	219 - 325,9	1000	16
03180FYU121A16	12G1,5	0,972 x 0,546 - 24,7 x 13,9	263 - 391,4	1000	16
03180FYU161A16	16G1,5	1,030 x 0,624 - 26,2 x 15,8	318 - 473,2	1000	16
03180FYU241A16	24G1,5	1,195 x 0,760 - 30,3 x 19,3	430 - 640	1000	16

Other dimensions and colors available on request.

BASKET CABLES

BASKET SPREADER 730



Suitable for sprayer application

ELETTROTEK KABEL® BASKET SPREADER 730

Construction:

Conductor:	flexible tinned copper conductor Cl. 5, acc to IEC 60228, DIN VDE 0295
Insulation:	special rubber EPR compound
Cores color:	black cores with consecutive numbers acc. to EN 50334
Central unit:	aramide yarns (with a minimum tensile strength of 10 kN)
Stranding:	cores in sextuples with short lay length
Wrapping:	special tape
Outer sheath:	black (similar to RAL 9005), special rubber CSP compound

Resistance:



Self-extinguishing and flame retardant acc. to:
DIN VDE 0482 part 265-2-1
EN 50265-2-1
IEC 60332-1-2



Oil resistance acc. to:
DIN VDE 0473 part 811-2-1
IEC EN 60811-2-1

Technical data:

Nominal voltage:	U ₀ /U 300/500 V max. 550 V
Test voltage:	2 kV
Temperature range:	
<i>Fixed laying:</i>	-40°C up to +90°C
<i>Flexible application:</i>	-25°C up to +70°C
Max. temp on conductor:	
<i>In service:</i>	up to +90°C
<i>In short circuit:</i>	up to +250°C
Min. bending radius:	15 x D
Tensile strength:	max. 4000 N
Max speed (main application):	160 m/min

Features:

UV, weather, and moisture resistance
outdoor use
vertical use
for SPEED see pages from 2 to 4 of catalogue
RoHS and CE approval



Part no.	No. of cores x cross section n x mm ²	Outer-Ø ca.mm ± 10%	Cable weight approx. kg/km	Tensile strength N	AWG no.®)
03140D71066M25	6x(6x2,5)	41	2790	4000	14
03140D71076M25	7x(6x2,5)	45	3260	4000	14
03140D71086M25	8x(6x2,5)	48,5	3690	4000	14
03140D71096M25	9x(6x2,5)	52	4280	4000	14
03140D71066M33	6x(6x3,3)	44,5	3380	4000	12
03140D71076M33	7x(6x3,3)	49	3980	4000	12
03140D71086M33	8x(6x3,3)	53	4560	4000	12
03140D71096M33	9x(6x3,3)	57,5	5310	4000	12

Other dimensions and colors available on request.

BASKET CABLES

BASKET SPREADER 740 (YSLTOE)

Control cable hoisting cages in crane systems

ELETTROTEK KABEL® BASKET SPREADER 740 (YSLTOE)



Suitable for spreader application

Construction:

Conductor:	flexible red copper conductor Cl. 6, acc to IEC 60228, DIN VDE 0295
Insulation:	PVC type Y12
Cores color:	black cores with consecutive numbers acc. to EN 50334 + green/yellow
Central unit:	aramide yarns whit lead
Stranding:	cores are twisted to bundle with central lead core, bundles twisted around central unit
Wrapping:	non-woven tape, on each bundle and overall
Outer sheath:	black (similar to RAL 9005), PUR type 11YM1

Resistance:



Self-extinguishing and flame retardant acc. to:
DIN VDE 0482 part 265-2-1
EN 50265-2-1
IEC 60332-1-2



Oil resistance acc. to:
DIN VDE 0282 part. 10
IEC EN 60811-2-1

Technical data:

Nominal voltage:	U ₀ /U 300/500 V
Max. operating voltage in A.C. systems:	U ₀ /U 310/550 V
Max. operating voltage in D.C. systems:	U ₀ /U 410/825 V
Test voltage:	2 kV
Temperature range:	
<i>Fixed laying:</i>	-20°C up to +60°C
<i>Flexible application:</i>	-20°C up to +60°C
Max. temp on conductor:	
<i>In service:</i>	up to +70°C
<i>In short circuit:</i>	up to +150°C
Min. bending radius:	15 x D
Tensile strenght:	up to 15 n/mm ²
Max. torsion:	± 25°/1mt.
Max speed (main application):	160 m/min

Features:

UV, ozone, and moisture resistance
outdoor/indoor use
up to 50 mt. suspension length
high breaking load of supporting unit
cold version on request
possible constructions: control cables with Bus or Fibre Optics element
UL/CSA approval on request
GOST-R approval on request
for SPEED see pages from 2 to 4 of catalogue
CE approval

CE

BASKET CABLES

BASKET SPREADER 740 (YSLTOE)

Control cable hoisting cages in crane systems

ELETTROTEK KABEL® BASKET SPREADER 740 (YSLTOE)



Suitable for spreader application

YSLTOE-J control cables

Part no.	No. of cores x cross section n x mm ²	Outer-Ø ca.mm ± 10%	Copper weight kg/km	Cable weight approx. kg/km	AWG no.®)
03150D70481M10	48G1	32	460,8	1900	18
03150D70241M25	24G2,5	30	576	1650	14
03150D70301M25	30G2,5	32,6	720	2050	14
03150D70361M25	36G2,5	36,2	864	2350	14
03150D70421M25	42G2,5	38,5	1008	3050	14
03150D70481M25	48G2,5	42,5	1152	3450	14
03150D70541M25	54G2,5	47	1296	3490	14
03150D70201M35	20G3,5	32,3	672	2000	12
03150D70241M35	24G3,5	32,5	806,4	2080	12
03150D70301M35	30G3,5	36,6	1008	2650	12
03150D70361M35	36G3,5	39,5	1209,6	3300	12
03150D70421M35	42G3,5	41,2	1411,2	3800	12
03150D70481M35	48G3,5	44,1	1612,8	4150	12
03150D70541M35	54G3,5	44,3	1814,4	4430	12

Other dimensions and colors available on request.

LIFT CABLES



LIFT CABLES

COMBI/BASKET LIFT 73 I

Control cable hoisting cages in crane systems

ELETTROTEK KABEL® COMBI/BASKET LIFT 73 I



Suitable for spreader application

Construction:

- Conductor:** flexible red copper conductor Cl. 6, acc. to IEC 60228, DIN VDE 0295
- Insulation:** PVC type YK cold resistant
- Cores color:** black cores with consecutive numbers acc. to EN 50334 + green/yellow
- Central unit:** Kevlar
- Outer sheath:** black (similar to RAL 9005), special PVC type YK cold resistant

Resistance:



Self-extinguishing and flame retardant acc. to:
DIN VDE 0482 part 265-2-1
EN 50265-2-1
IEC 60332-1-2



Oil resistance acc. to:
DIN VDE 0473 part 811-2-1
IEC EN 60811-2-1

Technical data:

- Nominal voltage:**
Control: U₀/U 300/500 V
Power: U₀U 0,6/1 kV
- Test voltage:**
Control: 2 kV
Power: 4 kV
- Temperature range:**
Fixed laying: -40°C up to +70°C
Flexible application: -20°C up to +70°C
- Min. bending radius:** 10 x D
- Max speed (main application):** 250 m/min

Features:

- vertical use
- resistant to low temperatures
- for SPEED see pages from 2 to 4 of catalogue
- RoHS and CE approval



Applications:

this hybrid cable is used for current carrying in the control system of vertical lifts using in buildings industry.

Part no.	No. of cores x cross section n x mm ²	Outer-Ø ca.mm ± 10%	Copper weight kg/km	Cable weight approx. kg/km	AWG no.®)
07010G70059900	5G2,5 + 10x1	20	220	306	14
07010G70059901	5G2,5 + 11x1	20	225,6	320	14
07010G70039902	3G4 + 7x1	17,4	184	360	12
07010G70049903	4G6 + 9x1	20,5	330	555	10
07010G70049904	4G6 + 11x1	21	340	575	10
07010G70049905	4G6 + 15x1	22	388	625	10
07010G70049906	4G10 + 10x1	25	480	870	8
07010G70049907	4G16 + 6x1	26,1	700	1250	6
07010G70049908	4G16 + 10x1	29	710	1300	6
07010G70049909	4G16 + 15x1	31,5	760	1380	6
07010G70049910	4G16 + 1x2,5 + 4x1	28,5	830	1460	6
07010G70059911	5G4 + 5x2x1,5	26,1	336	832,7	12
07010G70059912	5G6 + 5x2x1,5	28,6	432	1021,5	10
07010G70059913	5G10+2,5x1,5	30,9	634	1316,8	8
07010G70059914	5G4+8x1,5	25,6	307,2	784,4	12
07010G70059915	5G6+8x1,5	26,9	403,2	916,8	10
07010G70061M25	6G2,5	14	144	313,8	14

Other dimensions and colors available on request.

LIFT CABLES

PV-FLAT H05VVH6-F/LIFT

ELETTROTEK KABEL® PV-FLAT H05VVH6-F/LIFT



Construction:

- Conductor:** flexible red copper conductor Cl. 6, acc. to IEC 60228, DIN VDE 0295
- Insulation:** PVC special compound
- Stranding:** parallel cores laying
- Cores color:** acc. to DIN VDE 0293-308, HD 308 S2 from 6 cores black cores with consecutive numbers acc. to EN 50334; green-yellow earth-wire from 3 cores
- Outer sheath:** black (similar to RAL 9005), special PVC compound

Resistance:



Self-extinguishing and flame retardant acc. to:
DIN VDE 0482 part 265-2-1
EN 50265-2-1
IEC 60332-1-2



Oil resistance acc. to:
DIN VDE 0473 part 811-2-1
IEC EN 60811-2-1

Technical data:

- Nominal voltage:** U₀/U 300/500 V (up to 1 mm²)
- Test voltage:** 2 kV
- Temperature range:**
- Fixed laying:* -40°C up to +80°C
- Flexible application:* -5°C up to +70°C
- Min. bending radius:** 10 x D
- Max speed (main application):** 120 m/min
- Radiation resistance:** up to 80 x 10⁶ cJ/kg (up to 80 mrad)

Features:

- high flexibility
- for SPEED see pages from 2 to 4 of catalogue
- RoHS and CE approval



Part no.	No. of cores x cross section n x mm ²	Outer-Ø ca.mm ± 10%	Copper weight kg/km	Cable weight approx. kg/km	AWG no.®)
07020D72041M07	4G0,75	4,3 x 12,6	28,8	90	19
07020D72051M07	5G0,75	4,3 x 16,1	36	115	19
07020D70061M07	6G0,75	4,3 x 19,4	43,2	141	19
07020D70081M07	8G0,75	4,3 x 26,4	64,8	198	19
07020D70091M07	9G0,75	-	58	190	19
07020D70101M07	10G0,75	4,3 x 30,1	72	224	19
07020D70121M07	12G0,75	4,3 x 33,8	84,4	258	19
07020D70161M07	16G0,75	4,3 x 44,4	115,2	340	19
07020D70181M07	18G0,75	4,3 x 49,2	129,6	380	19
07020D70201M07	20G0,75	4,3 x 55	144	424	19
07020D70241M07	24G0,75	4,3 x 65,6	172,8	509	19
07020D72031M10	3G1	4,5 x 10,8	28,8	80	18
07020D72041M10	4G1	4,5 x 13,4	38,4	104	18
07020D72051M10	5G1	4,5 x 16	48	134	18
07020D70061M10	6G1	4,5 x 20,6	57,6	161	18
07020D70081M10	8G1	-	77	220	18
07020D70091M10	9G1	4,5 x 28,4	86,4	230	18
07020D70101M10	10G1	4,5 x 30	96	256	18
07020D70121M10	12G1	4,5 x 36,2	115,2	298	18
07020D70161M10	16G1	4,5 x 47,6	153,6	395	18
07020D70181M10	18G1	4,5 x 52,8	172,8	441	18
07020D70201M10	20G1	4,5 x 59	192	495	18
07020D70241M10	24G1	4,5 x 70,4	230,4	590	18

Other dimensions and colors available on request.

LIFT CABLES

ROUND LIFT 732

Flexible, rubber cables, with support again

ELETTROTEK KABEL® ROUND LIFT 732



Construction:

Conductor:	flexible red copper conductor Cl. 6, acc. to IEC 60228, DIN VDE 0295
Insulation:	rubber compound
Cores color:	acc. to DIN VDE 0293-308, HD 308 S2 from 6 cores black cores with consecutive numbers acc. to EN 50334; green-yellow earth-wire from 3 cores
Central unit:	high-tech yarns
Stranding:	in layers
Wrapping:	non-woven tape
Outer sheath:	black (similar to RAL 9005), rubber compound

Resistance:



Self-extinguishing and flame retardant acc. to:
DIN VDE 0482 part 265-2-1
EN 50265-2-1
IEC 60332-1-2



Oil resistance acc. to:
DIN VDE 0473 part 811-2-1
IEC EN 60811-2-1

Technical data:

Nominal voltage:	U ₀ /U 300/500 V
Test voltage:	3 kV
Temperature range:	
<i>Fixed laying:</i>	-40°C up to +80°C
<i>Flexible application:</i>	-25°C up to +60°C
Min. bending radius:	12,5 x D

Features:

UV, ozone, abrasion and oil resistant
high notch resistant
RoHS and CE approval



Applications:

as a robust and weather resistant cable for machines, equipment, which are constantly exposed to outdoor weather conditions (lift, building machinery, conveyor hoist systems etc.).conveyor hoist systems

LIFT CABLES

ROUND LIFT 732

Flexible, rubber cables, with support again

ELETTROTEK KABEL® ROUND LIFT 732

Part no.	No. of cores x cross section n x mm ²	Outer-Ø ca.mm ± 10%	Copper weight kg/km	Cable weight approx. kg/km	AWG no.*)
03130D73020M10	2x1	7,5	19,2	90	18
03130D72031M10	3G1	8,5	28,8	111	18
03130D72041M10	4G1	9,7	38,4	141	18
03130D72051M10	5G1	11,5	48	170	18
03130D70061M10	6G1	13,4	57,6	187	18
03130D70071M10	7G1	13,8	67,2	204	18
03130D70091M10	9G1	15,8	86,4	274	18
03130D70121M10	12G1	17,5	115,2	389	18
03130D70161M10	16G1	19,2	153,6	432	18
03130D70181M10	18G1	21,5	172,8	471	18
03130D70191M10	19G1	22	182,4	565	18
03130D70201M10	20G1	22,4	192	590	18
03130D70241M10	24G1	23,6	230,4	650	18
03130D70301M10	30G1	24,6	288	785	18
03130D70361M10	36G1	29,0	345,6	910	18
03130D70371M10	37G1	30,5	355,2	936	18
03130D70481M10	48G1	31,4	460,8	1244	18
03130D70501M10	50G1	32,6	480	1296	18
03130D70541M10	54G1	32,9	518,4	1399	18
03130D70611M10	61G1	37,2	585,6	1495	18
03130D73020M15	2x1,5	8,5	28,8	95	16
03130D72031M15	3G1,5	9,3	43,2	113	16
03130D72041M15	4G1,5	10,5	57,6	150	16
03130D72051M15	5G1,5	12,5	72	180	16
03130D70061M15	6G1,5	14,3	86,4	245	16
03130D70071M15	7G1,5	14,8	100,8	309	16
03130D70081M15	8G1,5	15,8	115,2	333	16
03130D70091M15	9G1,5	17,7	129,6	360	16
03130D70101M15	10G1,5	18,5	144	405	16
03130D70111M15	11G1,5	20,1	158,4	458	16
03130D70121M15	12G1,5	21,6	172,8	516	16
03130D70131M15	13G1,5	22,1	187,2	-	16
03130D70151M15	15G1,5	22,8	216	590	16
03130D70181M15	18G1,5	23,6	259,2	620	16
03130D70191M15	19G1,5	24,1	273,6	670	16
03130D70241M15	24G1,5	27	345,6	817	16
03130D70371M15	37G1,5	31	532,8	1220	16
03130D70421M15	42G1,5	33	604,8	1380	16
03130D70481M15	48G1,5	34,9	691,2	1510	16
03130D70501M15	50G1,5	36,7	720	1642	16
03130D70611M15	61G1,5	41,8	878,4	1950	16
03130D73020M25	2x2,5	10	48	142	14
03130D72031M25	3G2,5	10,5	72	172	14
03130D72041M25	4G2,5	11,6	96	210	14
03130D72051M25	5G2,5	12,9	120	255	14
03130D70061M25	6G2,5	14,5	144	318	14
03130D70071M25	7G2,5	16,2	168	383	14
03130D70081M25	8G2,5	16,8	192	450	14
03130D70091M25	9G2,5	21,5	216	541	14
03130D70111M15	11G2,5	23,3	264	638	14
03130D70121M25	12G2,5	25,4	288	690	14
03130D70161M25	16G2,5	24,4	384	813	14
03130D70181M25	18G2,5	26,3	432	891	14
03130D70191M25	19G2,5	27,5	456	946	14
03130D70241M25	24G2,5	30,5	576	1221	14
03130D70361M25	36G2,5	33,5	864	1737	14
03130D70371M25	37G2,5	40,8	888	1784	14
03130D70481M25	48G2,5	41,9	1152	2500	14
03130D70501M25	50G2,5	43,3	1200	2630	14
03130D70611M25	61G2,5	49,3	1464	8100	14

LIFT CABLES

ROUND LIFT 732

Flexible, rubber cables, with support again

ELETTROTEK KABEL® ROUND LIFT 732



Part no.	No. of cores x cross section n x mm ²	Outer-Ø ca.mm ± 10%	Copper weight kg/km	Cable weight approx. kg/km	AWG no.*)
03130D72031M40	3G4	13,6	115,2	372	12
03130D72041M40	4G4	15,0	153,6	407	12
03130D72051M40	5G4	17,1	192,0	432	12
03130D70071M40	7G4	21,5	268,8	495	12
03130D72031M60	3G6	13,9	172,8	380	10
03130D72041M60	4G6	15,2	230,4	445	10
03130D72051M60	5G6	18,2	288	569	10
03130D70071M60	7G6	21,1	403,2	702	10
03130D72031M61	3G10	18,1	288	530	8
03130D72041M61	4G10	20,6	384	724	8
03130D72051M61	5G10	22,6	480	923	8
03130D70071M61	7G10	27,4	672	1288	8
03130D72031M62	3G16	21,3	460,8	865	6
03130D72041M62	4G16	25,2	614,4	1028	6
03130D72051M62	5G16	26,5	768	1260	6

Other dimensions and colors available on request.



ROUND LIFT 733

lift control cable up to 60 mt.

ELETTROTEK KABEL® ROUND LIFT 733



Construction:

Conductor:	flexible red copper conductor Cl. 6, acc. to IEC 60228, DIN VDE 0295
Insulation:	GAALTHERM® 535
Cores color:	black cores with consecutive numbers acc. to EN 50334 + green-yellow
Central unit:	sisal cord
Stranding:	in layers
Wrapping:	non-woven tape over each layer
Supporting screen:	special anti-twisting protection
Outer sheath:	black (similar to RAL 9005), special thermoplastic compound

Resistance:



Self-extinguishing and flame retardant acc. to:
DIN VDE 0482 part 265-2-1
EN 50265-2-1
IEC 60332-1-2



Halogen-free acc. to:
DIN VDE 0482 part 267,
EN 50267-2-1,
IEC 60754-1

Technical data:

Nominal voltage:	U ₀ /U 300/500 V
Test voltage:	2 kV
Temperature range:	
<i>Fixed laying:</i>	-50°C up to +90°C
<i>Flexible application:</i>	-40°C up to +90°C
Min. bending radius:	15 x D
Max. suspended height:	up to 60 mt.
Max. Resistance at 20°C:	19,5 Ohm/km

Features:

possible with integrated bus cable
RoHS and CE approval



Applications:

Used in the highest safety requirements

Part no.	No. of cores x cross section n x mm ²	Outer-Ø ca.mm ± 10%	Copper weight kg/km	Cable weight approx. kg/km	AWG no.*)
07030D70071M10	7G1	12	67,2	190	18
07030D70241M10	24G1	22,5	230,4	600	18
07030D70301M10	30G1	23,5	288	720	18

Other dimensions and colors available on request.

LIFT CABLES

PENDANT ROUND LIFT 733 UL

pendant control cable up to 60 mt.



Construction:

Conductor:	finely stranded red copper acc.to ASTM B-3 or ASTM B-174
Insulation:	PVC/Nylon special compound
Cores color:	acc. to ICEA Method 1-E2 (K-2)
Central unit:	PVC filler
Stranding:	in layers
Wrapping:	mylar tape
Outer sheath:	yellow (similar to RAL 1021), PVC compound

Resistance:



Self-extinguishing and flame retardant acc. to:

DIN VDE 0482 part 265-2-1
EN 50265-2-1
IEC 60332-1-2
UL type MTW, VW-1,
CSA AWM, FT-1

Technical data:

Nominal voltage:	U ₀ /U 600 V
Test voltage:	2 kV
Temperature range:	(UL) / c(UL)
<i>Fixed laying:</i>	-25°C up to +90°C
<i>Flexible application:</i>	-25°C up to +90°C
Min. bending radius:	10 x D

Features:

UL 90°C 600 V
CSA AWM I/II A/B 90°C 600 V

Part no.	No. of cores x cross section n x mm ²	Outer-Ø inches/mm ± 10%	Cable weight approx. Lbs/Mft-kg/km	Max. tensile strength N	AWG no. ^{*)}
07050FYU081A16	8G1,5	0,479 - 12,2	158 - 235	1000	16
07050FYU121A16	12G1,5	0,566 - 14,4	217 - 323	1000	16
07050FYU161A16	16G1,5	0,605 - 15,4	255 - 380	1000	16
07050FYU241A16	24G1,5	0,755 - 19,2	-	1000	16
07050FYU301A16	30G1,5	0,803 - 20,4	-	1000	16
07050FYU361A16	36G 1,5	0,905 - 23	-	1000	16

Other dimensions and colors available on request.

ROUND LIFT 734

lift control cable up to 200 mt.



ELETTROTEK KABEL® ROUND LIFT 734

Construction:

Conductor:	flexible red copper conductor Cl. 6, acc. to IEC 60228, DIN VDE 0295
Insulation:	GAALTHERM® 535
Cores color:	black cores with consecutive numbers acc. to EN 50334 + green-yellow
Central unit:	steel element
Stranding:	in layers
Wrapping:	non-woven tape over each layer
Supporting screen:	special anti-twisting protection
Outer sheath:	black (similar to RAL 9005), special thermoplastic compound

Resistance:



Self-extinguishing and flame retardant acc. to:
DIN VDE 0482 part 265-2-1
EN 50265-2-1
IEC 60332-1-2



Halogen-free acc. to:
DIN VDE 0482 part 267,
EN 50267-2-1,
IEC 60754-1

Technical data:

Nominal voltage:	U ₀ /U 300/500 V
Test voltage:	2 kV
Temperature range:	
<i>Fixed laying:</i>	-50°C up to +90°C
<i>Flexible application:</i>	-40°C up to +90°C
Min. bending radius:	15 x D
Max. suspended height:	up to 200 mt.
Max. Resistance at 20°C:	19,5 Ohm/km

Features:

possible with integrated bus cable
RoHS and CE approval



Applications:

used in the highest safety requirements

Part no.	No. of cores x cross section n x mm ²	Outer-Ø ca.mm ± 10%	Copper weight kg/km	Cable weight approx. kg/km	AWG no.)*
07040D70241M10	24x1	19	230,4	600	18
07040D70301M10	30x1	21,3	288	775	18

Other dimensions and colors available on request.



MINING CABLES



MINING CABLES

FLEXIMINING® R 400 WATER PROOF

Rubber Sheathed cable, water proof AD8

ELETTROTEK KABEL® FLEXIMINING® R 400 WATER PROOF



Construction:

Conductor:	flexible red copper conductor Cl. 5, acc to IEC 60228, DIN VDE 0295
Insulation:	GAALTHERM® 530
Cores color:	acc. to DIN VDE 0293-308, HD 308 S2 from 6 cores black cores with consecutive numbers acc. to EN 50334; green-yellow earth-wire from 3 cores
Inner sheath:	special water blocking compound
Outer sheath:	blue (similar to RAL 5015), rubber PCP type EM2, acc. to DIN VDE 0282 part. 1

Technical data:

Nominal voltage:	U ₀ /U 450/750 V
Test voltage:	2,5 kV
Temperature range:	
<i>Fixed laying:</i>	-40°C up to +60°C
<i>Flexible application:</i>	-15°C up to +60°C
<i>In service:</i>	up to +80°C
<i>In short circuit</i>	up to +250°C
Min. bending radius:	
<i>Fixed laying:</i>	4 x D
<i>Flexible installation:</i>	6 x D
Tensile strenght:	15 N/mm ²

Resistance:



Self-extinguishing and flame retardant acc. to:
DIN VDE 0482 part 265-2-1
EN 50265-2-1
IEC 60332-1-2

Features:

dreadging application!
ozone and weather resistant
water proof AD8
installation in water up to 100 mt. depth
pressure up to 80 bars
on request 0,6/1 kV
for MINIMUM BENDING RADIUS
see pages from 5 to 8 of catalogue
RoHS and CE approval



MINING CABLES

FLEXIMINING® R 400 WATER PROOF

Rubber Sheathed cable, water proof AD8

ELETTROTEK KABEL® FLEXIMINING® R 400 WATER PROOF



Part no.	No. of cores x cross section n x mm ²	Outer-Ø ca.mm ± 10%	Copper weight kg/km	Cable weight approx. kg/km	AWG no.*)
06100EBL010M15	1x1,5	6,4	14	50	16
06100EBL010M25	1x2,5	7,1	24	70	14
06100EBL010M40	1x4	8,1	38	100	12
06100EBL010M60	1x6	8,9	58	130	10
06100EBL010M61	1x10	10,7	96	200	8
06100EBL010M62	1x16	12,1	154	280	6
06100EBL010M63	1x25	14,2	240	400	4
06100EBL010M64	1x35	16,1	336	510	2
06100EBL010M65	1x50	18,5	480	710	1
06100EBL010M66	1x70	21	672	950	2/0
06100EBL010M67	1x95	23,4	912	1200	3/0
06100EBL010M68	1x120	25,7	1152	1500	4/0
06100EBL010M69	1x150	28,3	1440	1850	250 MCM
06100EBL010M70	1x185	31	1776	2220	350 MCM
06100EBL010M71	1x240	34,4	2304	2830	450 MCM
06100EBL010M72	1x300	37,6	2880	3470	550 MCM
06100EBL010M73	1x400	42,1	3840	4430	750 MCM
06100EB2031M15	3G1,5	10,5	43	150	16
06100EB2031M25	3G2,5	12,5	72	210	14
06100EB2031M40	3G4	14,5	115	280	12
06100EB2031M60	3G6	16	173	370	10
06100EB2031M61	3G10	21,7	288	660	8
06100EB2031M62	3G16	24,7	461	920	6
06100EB2031M63	3G25	29,5	720	1360	4
06100EB2031M64	3G35	33,2	1008	1820	2
06100EB2031M65	3G50	38,5	1440	2500	1
06100EB2031M66	3G70	43,3	2016	3350	2/0
06100EB2031M67	3G95	48,6	2736	4340	3/0
06100EB2031M68	3G120	53,7	3456	5230	4/0
06100EB2031M69	3G150	59	4320	6520	250 MCM
06100EB2031M70	3G185	64,5	5328	7950	350 MCM
06100EB2031M71	3G240	73,5	6912	10300	450 MCM
06100EB2031M72	3G300	81	8640	11700	550 MCM
06100EB2041M10	4G1	10,5	38	150	18
06100EB2041M15	4G1,5	11,5	58	190	16
06100EB2041M25	4G2,5	13,8	96	260	14
06100EB2041M40	4G4	16	154	350	12
06100EB2041M60	4G6	17,9	230	460	10
06100EB2041M61	4G10	23,7	384	830	8
06100EB2041M62	4G16	27	614	1190	6
06100EB2041M63	4G25	32,8	960	1720	4
06100EB2041M64	4G35	36,8	1334	2260	2
06100EB2041M65	4G50	42,5	1920	3140	1
06100EB2041M66	4G70	48,2	2688	4250	2/0
06100EB2041M67	4G95	54,7	3638	5500	3/0
06100EB2041M68	4G120	59,5	4608	6670	3/0
06100EB2041M69	4G150	65,5	5760	8390	250 MCM
06100EB2041M70	4G185	72	7104	10200	350 MCM
06100EB2041M71	4G240	81,5	9216	12500	450 MCM
06100EB0071M15	7G1,5	17	100	340	16
06100EB0071M25	7G2,5	19,5	168	530	14
06100EB0121M15	12G1,5	20	172,8	700	16
06100EB0121M25	12G2,5	23,4	288	960	14
06100EB0181M15	18G1,5	23,5	259	1360	16
06100EB0181M25	18G2,5	27,6	432	500	14
06100EB0241M15	24G1,5	27,5	346	720	16
06100EB0241M25	24G2,5	32,6	576	1050	14
06100EB0361M15	36G1,5	31,5	518	1350	16
06100EB0361M25	36G2,5	37,5	864	2360	14
06100EB0071M40	7x4	22,2	269	680	12
06100EB0121M40	12x4	27,7	461	1050	12
06100EB0181M40	18x4	32,6	691	1500	12

Other dimensions and colors available on request.

MINING CABLES

FLEXIMINING® R 40I WATER PROOF

PUR Sheathed cable, water proof AD8

ELETTROTEK KABEL® FLEXIMINING® R 40I WATER PROOF



Construction:

Conductor:	flexible red copper conductor Cl. 5, acc to IEC 60228, DIN VDE 0295
Insulation:	GAALTHERM® 590
Cores color:	acc. to DIN VDE 0293-308, HD 308 S2 from 6 cores black cores with consecutive numbers acc. to EN 50334; green-yellow earth-wire from 3 cores
Central unit:	aramid yarns
Inner sheath:	special water blocking compound
Outer sheath:	blue (similar to RAL 5015), special PUR compound

Resistance:



Self-extinguishing and flame retardant acc. to:
DIN VDE 0482 part 265-2-1
EN 50265-2-1
IEC 60332-1-2

Technical data:

Nominal voltage:	U ₀ /U 0,6/1 kV
Test voltage:	3,5 kV
Temperature range:	
<i>Fixed laying:</i>	-40°C up to +80°C
<i>Flexible application:</i>	-30°C up to +80°C
<i>In service:</i>	up to +90°C
<i>In short circuit</i>	up to +250°C
Min. bending radius:	
<i>Fixed laying:</i>	6 x D
<i>Flexible installation:</i>	8 x D
Tensile strenght:	15 N/mm ²

Features:

dreadging application!
ozone and weather resistant
water proof AD8
installation in water up to 100 mt. depth
on request other colors
for MINIMUM BENDING RADIUS
see pages from 5 to 8 of catalogue
RoHS and CE approval



Part no.	No. of cores x cross section n x mm ²	Outer-Ø ca.mm ± 10%	Copper weight kg/km	Cable weight approx. kg/km	AWG no.*)
06110GB2041M25	4G2,5	-	96	-	14
06110GB2041M40	4G4	-	154	-	12
06110GB2041M60	4G6	-	230	-	10
06110GB2041M61	4G10	16,2	384	560	8
06110GB2041M62	4G16	20,5	614	890	6
06110GB2031M63	3x25+3G6	22,8	893	1250	4/10
06110GB2031M64	3x35+3G6	26,5	1181	1680	2/10
06110GB2031M65	3x50+3G10	30,5	1728	2250	1/8
06110GB2031M66	3x70+3G16	35,5	2476	3200	2/0 /6
06110GB2031M67	3x95+3G16	40,8	3197	4000	3/0 /6
06110GB2031M68	3x120+3G25	44	4176	5050	4/0 /4
06110GB2031M69	3x150+3G25	30,3	5040	6240	300 MCM /4
06110GB2031M70	3x185+3G35	55,5	6336	7800	350 MCM /2
06110GB2031M71	3x240+3G50	64,5	8350	10050	500 MCM /1

Other dimensions and colors available on request.

MINING CABLES

FLEXIMINING® R 500 VFD

ELETTROTEK KABEL® FLEXIMINING® R 500 VFD



Construction:

Conductor:	flexible red copper conductor Cl. 5, acc to IEC 60228, DIN VDE 0295
Insulation:	GAALTHERM® 590
Cores color:	acc. to DIN VDE 0293-308, HD 308 S2 3 phase cores: brown-black-gray
Earth conductor screen:	semi-conducting compound + red copper braid
Central unit:	aramid yarns
Inner sheath:	thermoplastic compound
Supporting screen:	anti-twisting protection of fiber-glass braid
Outer sheath:	yellow (similar to RAL 1021), PUR compound

Resistance:



Self-extinguishing and flame retardant acc. to:
DIN VDE 0482 part 265-2-1
EN 50265-2-1
IEC 60332-1-2

Technical data:

Nominal voltage:	U ₀ /U 0,6/1 kV
Test voltage:	
<i>core/core:</i>	3,5 kV x 15 min.
<i>core/screen:</i>	2 kV x 15 min.
Temperature range:	
<i>Fixed laying:</i>	-40°C up to +80°C
<i>Flexible application:</i>	-30°C up to +80°C
<i>In service:</i>	up to +90°C
<i>In short circuit</i>	up to +250°C
Min. bending radius:	
<i>Fixed laying:</i>	6 x D
<i>Flexible installation:</i>	8 x D
Tensile strenght:	25 N/mm ²

Features:

tunneling machines!

weather, chemical and oil resistant

cable for reeling application with high mechanical stress

for MINIMUM BENDING RADIUS
see pages from 5 to 8 of catalogue

RoHS and CE approval



Applications:

cable for reeling applications with high
mechanical stress

FLEXIMINING® R 500 VFD
can be used in mining and tunneling machines

Part no.	No. of cores x cross section n x mm ²	Outer-Ø ca.mm ± 10%	Copper weight kg/km	Cable weight approx. kg/km	Tensile strength N	AWG no.®)
06120GY3030M63	3x25+3x25/3E	28,2	960	1700	1500	4/4
06120GY3030M64	3x35+3x25/3E	32	1248	2200	2100	2/4
06120GY3030M65	3x50+3x25/3E	35	1680	2900	3000	1/4
06120GY3030M66	3x70+3x35/3E	39,7	2352	3950	4200	2/0
06120GY3030M67	3x95+3x50/3E	45,5	3216	5100	5700	3/0 /1
06120GY3030M68	3x120+3x70/3E	49,2	4128	6350	7200	4/0 / 2/0
06120GY3030M69	3x150+3x70/3E	55	4992	7470	-	300 MCM / 2/0
06120GY3030M70	3x185+3x95/3E	59	6240	9180	-	350 MCM / 3/0
06120GY3030M71	3x240+3x120/3E	65	8064	11200	-	500 MCM / 4/0

Other dimensions and colors available on request.

MINING CABLES

FLEXIMINING® R 500 SWBA



Construction:

Conductor:	flexible red copper conductor Cl. 5, acc to IEC 60228, DIN VDE 0295
Insulation:	GAALTHERM® 590
Cores color:	acc. to DIN VDE 0293-308, HD 308 S2 3 conductors + 3 earth conductors: grey, brown, black and green/yellow divided in interstices 4 cores: green/yellow, brown, black, grey Control cores: white with printed numbers
Central unit:	armid yarns
Inner sheath:	thermoplastic compound
Armouring:	braid of galvanized steel wires
Outer sheath:	yellow (similar to RAL 1021), PUR compound

Technical data:

Nominal voltage:	U ₀ /U 0,6/1 kV
Test voltage:	
<i>core/core:</i>	3,5 kV x 15 min.
Temperature range:	
<i>Fixed laying:</i>	-40°C up to +80°C
<i>Flexible application:</i>	-30°C up to +80°C
<i>In service:</i>	up to +90°C
<i>In short circuit</i>	up to +250°C
Min. bending radius:	
<i>Fixed laying:</i>	6 x D
<i>Flexible installation:</i>	8 x D
Tensile strenght:	20 N/mm ²

Resistance:



Self-extinguishing and flame retardant acc. to:
DIN VDE 0482 part 265-2-1
EN 50265-2-1
IEC 60332-1-2

Features:

tunneling machines!

weather, chemical and oil resistant

cable for reeling application with high mechanical stress

for MINIMUM BENDING RADIUS
see pages from 5 to 8 of catalogue

RoHS and CE approval



Applications:

cable for reeling applications with high
mechanical stress

FLEXIMINING® R 500 VFD SWBA
can be used in mining and tunneling machines

MINING CABLES

FLEXIMINING® R 500 SWBA

ELETTROTEK KABEL® FLEXIMINING® R 500 SWBA

Part no.	No. of cores x cross section n x mm ²	Outer-Ø ca.mm ± 10%	Copper weight kg/km	Cable weight approx. kg/km	Tensile strength N	AWG no.*)
06130GY2041M25	4G2,5	13,9	96	325	200	14
06130GY2041M40	4G4	15,2	153,6	415	320	12
06130GY2041M60	4G6	16,7	230,4	548	480	10
06130GY2041M61	4G10	20,5	384	830	800	8
06130GY2041M62	4G16	24,5	614,4	1220	1280	6
06130GY2041M63	4G25	29	960	1480	2000	4
06130GY2041M64	4G35	33,5	1344	1760	2800	2
06130GY2041M65	4G50	38	1920	2100	4000	1
06130GY2041M66	4G70	43	2688	2520	5600	2/0
06130GY2037M63	3x25+3G6	27	892,8	1600	1500	4
06130GY2037M64	3x35+3G6	31	1180,8	2100	2100	2
06130GY2037M65	3x50+3G10	34,5	1728	2850	3000	1
06130GY2037M66	3x70+3G16	39,5	2476,8	3900	4200	2/0
06130GY2037M67	3x95+3G16	45	3196,8	5100	5700	3/0
06130GY2037M68	3x120+3G25	49,5	4176	6350	7200	4/0
06130GY2037M69	3x150+3G25	56	5040	7800	9000	250 MCM
06130GY2037M70	3x185+3G35	61	6336	9600	11100	350 MCM
06130GY2037M70	3x240+3G50	70	8354	12550	14400	450 MCM
06130GY2037M71	3x300+3G50	73,5	10080	14550	18000	550 MCM
06130GY2051M25	5G2,5	14,7	120	375	250	16
06130GY2051M40	5G4	16,7	192	500	400	16
06130GY2051M60	5G6	18,7	288	660	600	16
06130GY2051M61	5G10	22	480	1000	1000	16
06130GY2051M62	5G16	26	768	1450	1600	16
06130GY2051M63	5G25	31,2	1200	2030	2500	16
06130GY2051M64	5G35	35,2	1680	2685	3500	16
06130GYA070M15	7G1,5	15,2	100,8	375	210	16
06130GYA120M15	12G1,5	19,7	172,8	530	360	16
06130GYA180M15	18G1,5	19,7	259,2	580	540	16
06130GYA240M15	24x1,5	23,2	345,6	960	720	14
06130GYA070M25	7G2,5	17	168	520	350	14
06130GYA120M25	12G2,5	21	288	780	600	14
06130GYA180M25	18G2,5	22,5	432	1090	900	14
06130GYA190M25	19G2,5	24,5	456	1120	950	14
06130GYA240M25	24G2,5	26,5	576	1240	1200	14
06130GYA270M25	27G2,5	28,5	648	1530	1350	14
06130GYA370M25	37x2,5	32	888	1950	1850	14

Other dimensions and colors available on request.



ELETTROTEK KABEL® FLEXIMINING® NSSHÖU 0,6/1 KV

Construction:

Conductor:	flexible tinned copper conductor Cl. 5, acc to IEC 60228, DIN VDE 0295
Insulation:	rubber EPR type 3GI3 acc. to DIN VDE 0207
Cores color:	acc. to DIN VDE 0293-308, HD 308 S2 from 6 cores black cores with consecutive numbers acc. to EN 50334; green-yellow earth-wire from 3 cores, or: acc. to DIN VDE 0293-308, HD 308 S2 3 conductors + 1 earth conductors: grey, brown, black and green/yellow, or: acc. to DIN VDE 0293-308, HD 308 S2 3 conductors + 3 earth conductors: grey, brown, black and green/yellow divided in interstices
Stranding:	in layers around central unit with short lay-length
Inner sheath:	rubber EPR type GM1b
Outer sheath:	yellow (similar to RAL 1021), rubber PCP type 5GM5 acc. to DIN VDE 0207 part 21

Resistance:



Self-extinguishing and flame retardant acc. to:
DIN VDE 0482 part 265-2-1
EN 50265-2-1
IEC 60332-1-2



Oil resistance acc. to:
DIN VDE 0473 part 811-2-1
IEC EN 60811-2-1

Technical data:

Nominal voltage:	U ₀ /U 0,6/1 kV
Test voltage:	3 kV
Max. operating voltage:	A.C. U ₀ /U = 0,7/1,2 kV D.C. U ₀ /U = 0,9/1,8 kV
Temperature range:	
<i>Fixed laying:</i>	-40°C up to +80°C
<i>Flexible application:</i>	-25°C up to +80°C
Min. bending radius:	
<i>Fixed laying:</i>	4x D
<i>Flexible installation:</i>	5 x D
Tensile strength:	
<i>Static:</i>	15 N/mm ²
Insulation resistance:	> 20 MOhm*km

Features:

mining Excavator!

weather, ozone, abrasion and oil resistant

high insulation resistance

resistant against hot penetration

high notch resistance

resistant against oils fat and chemicals

MSHA, GOST-R and WUG approvals on request

for MINIMUM BENDING RADIUS see pages from 5 to 8 of catalogue

RoHS and CE approval



Applications:

For application in underground mines

MINING CABLES

FLEXIMINING® NSSHÖU



ELETTROTEK KABEL® FLEXIMINING® NSSHÖU 0,6/1 KV

Part no.	No. of cores x cross section n x mm ²	Outer-Ø ca.mm ± 10%	Copper weight kg/km	Cable weight approx. kg/km	Tensile strength N	AWG no.)*
05010GYL010M62	1x16	11,4	154	230	240	6
05010GYL010M63	1x25	13,8	240	350	375	4
05010GYL010M64	1x35	14,9	336	455	525	2
05010GYL010M65	1x50	17,2	480	625	750	1
05010GYL010M66	1x70	19	672	825	1050	2/0
05010GYL010M67	1x95	21,5	912	1080	1425	3/0
05010GYL010M68	1x120	23,7	1152	1340	1800	4/0
05010GYL010M69	1x150	25,9	1440	1650	2250	250 MCM
05010GYL010M70	1x185	28,9	1776	2040	2775	350 MCM
05010GYL010M71	1x240	31,9	2304	2680	3600	450 MCM
05010GYL010M72	1x300	36,2	2880	3370	4500	550 MCM
05010GY3020M15	2x1,5	11,8	29	160	45	16
05010GY3020M25	2x2,5	26,2	48	210	75	14
05010GY3020M40	2x4	15,5	77	300	120	12
05010GY3020M60	2x6	16,6	115,2	360	-	10
05010GY3020M61	2x10	19,9	192	550	-	8
05010GY3020M62	2x16	22,3	307,2	730	-	6
05010GY3020M63	2x25	26,8	480	1100	-	4
05010GY3020M64	2x35	28,9	67,2	1230	-	2
05010GY2031M15	3G1,5	12,3	43	180	68	16
05010GY3030M25	3x2,5	13,7	72	240	113	14
05010GY2031M25	3G2,5	13,7	72	240	113	14
05010GY3030M40	3x4	16,3	115	355	180	12
05010GY2031M40	3G4	16,3	115	355	180	12
05010GY3030M60	3x6	17,5	173	425	270	10
05010GY2031M60	3G6	17,5	173	425	270	10
05010GY3030M61	3x10	21,1	288	670	450	8
05010GY3030M62	3x16	23,6	461	900	720	6
05010GY3030M63	3x25	28	720	1330	1125	4
05010GY3030M64	3x35	32	1008	1800	1575	2
05010GY3030M65	3x50	36,1	1440	2390	2250	1
05010GY3030M66	3x70	42,3	2016	3280	3150	2/0
05010GY3030M67	3x95	48,3	2736	4320	4275	3/0
05010GY3030M68	3x120	49,3	3456	4910	5400	4/0
05010GY2041M15	4G1,5	13,2	58	215	90	16
05010GY2041M25	4G2,5	15,9	96	325	150	14
05010GY2041M40	4G4	17,4	154	415	240	12
05010GY2041M60	4G6	21,2	230	515	360	10
05010GY2041M61	4G10	24,6	384	815	600	8
05010GY2041M62	4G16	28,8	614	1170	960	6
05010GY2041M63	4G25	34,6	960	1730	1500	4
05010GY2041M64	4G35	38,9	1344	2220	2100	2
05010GY2041M65	4G50	45,1	1920	3150	3000	1
05010GY2041M66	4G70	45,9	2688	4110	4200	2/0
05010GY2041M67	4G95	52,4	3648	5400	5700	3/0
05010GY2041M68	4G120	58,2	4608	6760	7200	4/0
05010GY2051M15	5G1,5	14,1	72	255	113	16
05010GY2051M25	5G2,5	17	120	385	188	14
05010GY2051M40	5G4	18,7	192	505	300	12
05010GY2051M60	5G6	24,6	288	660	450	10
05010GY2051M61	5G10	28,8	480	980	750	8
05010GY2051M62	5G16	34,6	768	1420	1200	6
05010GY2051M63	5G25	38,9	1200	2120	1875	4
05010GY2051M64	5G35	45,1	1680	2800	-	2
05010GY2051M65	5G50	51,7	2400	3850	-	1
05010GY0071M15	7G1,5	17,6	101	370	158	16
05010GY0121M15	12G1,5	20,3	173	535	315	16
05010GY0181M15	18G1,5	22,9	202	710	427	16
05010GY0071M25	7G2,5	19,08	192	510	300	14
05010GY0121M25	12G2,5	23,4	288	750	450	14
05010GY0181M25	18G2,5	27,1	432	1060	675	14

MINING CABLES

FLEXIMINING® NSSHÖU



ELETTROTEK KABEL® FLEXIMINING® NSSHÖU 0,6/1 KV

Part no.	No. of cores x cross section n x mm ²	Outer-Ø ca.mm ± 10%	Copper weight kg/km	Cable weight approx. kg/km	Tensile strength N	AWG no.*)
05010GY2035M63	3x25/16	28,2	874	1460	1125	4
05010GY2035M64	3x35/25	32,5	1248	2020	1575	2
05010GY2035M65	3x50/25	39	1680	2840	2250	1
05010GY2035M66	3x70/35	42,9	2352	3650	3150	2/0
05010GY2035M67	3x95/50	50,4	3216	4880	4275	3/0
05010GY2035M68	3x120/70	56,1	4128	6260	5400	4/0
05010GY2035M69	3x150/70	57,4	4992	7080	6750	250 MCM
05010GY2035M70	3x185/95	63,8	6240	8740	8325	350 MCM
05010GY2035M71	3x240/120	69,9	8064	10820	10800	450 MCM
05010GY2035M72	3x300/150	74,6	10080	12950	13500	550 MCM
05010GY2037M40	3x4+3G4/3	18,6	153,6	500	180	12
05010GY2037M60	3x6+3G6/3	20,1	230,4	630	270	10
05010GY2037M61	3x10+3G10/3	24,5	384	950	450	8
05010GY2037M62	3x16+3G16/3	26,4	614,4	1225	720	6
05010GY2037M63	3x25+3G16/3	29,9	873,6	1605	1125	4
05010GY2037M64	3x35+3G16/3	31	1161,6	1875	1575	2
05010GY2037M65	3x50+3G25/3	36,7	1680	2660	2250	1
05010GY2037M66	3x70+3G35/3	40,3	2352	3520	3150	2/0
05010GY2037M67	3x95+3G50/3	46,9	3216	4580	4275	3/0
05010GY2037M68	3x120+3G70/3	49,1	4128	5710	5400	4/0
05010GY2037M69	3x150+3G70/3	54	4992	6650	6750	250 MCM
05010GY2037M70	3x185+3G95/3	59,7	6240	8240	8325	350 MCM
05010GY2037M71	3x240+3G120/3	65,8	8064	10390	10800	450 MCM
05010GY2037M72	3x300+3G150/3	72,2	10080	12570	13500	550 MCM

Other dimensions and colors available on request.

FLEXIMINING® (N)SHÖU



ELETTROTEK KABEL® FLEXIMINING® (N)SHÖU 0,6/1 kV

Construction:

Conductor:	flexible tinned copper conductor Cl. 5, acc to IEC 60228, DIN VDE 0295
Insulation:	rubber EPR type 3GI3 acc. to DIN VDE 0207
Cores color:	acc. to DIN VDE 0293-308, HD 308 S2 from 6 cores black cores with consecutive numbers acc. to EN 50334; green-yellow earth-wire from 3 cores
Stranding:	in layers around central unit with short lay-length
Inner sheath:	rubber EPR type GM1b
Outer sheath:	black (similar to RAL 9005), rubber PCP type 5GM5 acc. to DIN VDE 0207 part 21

Resistance:



Self-extinguishing and flame retardant acc. to:
DIN VDE 0482 part 265-2-1
EN 50265-2-1
IEC 60332-1-2



Oil resistance acc. to:
DIN VDE 0473 part 811-2-1
IEC EN 60811-2-1

Technical data:

Nominal voltage:	U ₀ /U 0,6/1 kV
Test voltage:	3 kV
Max. operating voltage:	A.C. U ₀ /U = 0,7/1,2 kV D.C. U ₀ /U = 0,9/1,8 kV
Temperature range:	
<i>Fixed laying:</i>	-40°C up to +80°C
<i>Flexible application:</i>	-25°C up to +80°C
Min. bending radius:	
<i>Fixed laying:</i>	4 x D
<i>Flexible installation:</i>	5 x D
Tensile strenght:	
<i>Static:</i>	15 N/mm ²
Insulation resistance:	> 20 MOhm*km

Features:

mining Excavator!

weather, ozone, abrasion and oil resistant

high insulation resistance

resistant against hot penetration

high notch resistance

resistant against oils fat and chemicals

MSHA, GOST-R and WUG approvals on request

for MINIMUM BENDING RADIUS
see pages from 5 to 8 of catalogue

RoHS and CE approval



Applications:

For application in open-cast mines

MINING CABLES

FLEXIMINING® (N)SHÖU



ELETTROTEK KABEL® FLEXIMINING® (N)SHÖU 0,6/1 kV

Part no.	No. of cores x cross section n x mm ²	Outer-Ø ca.mm ± 10%	Copper weight kg/km	Cable weight approx. kg/km	Tensile strength N	AWG no.*)
05020G7L010M62	1x16	10,6	154	235	240	6
05020G7L010M63	1x25	12,1	240	339	375	4
05020G7L010M64	1x35	13,4	336	431	525	2
05020G7L010M65	1x50	15,8	480	625	750	1
05020G7L010M66	1x70	17,7	672	838	1050	2/0
05020G7L010M67	1x95	19,8	912	1080	1425	3/0
05020G7L010M68	1x120	21,7	1152	1345	1800	4/0
05020G7L010M69	1x150	24,1	1440	1653	2250	250 MCM
05020G7L010M70	1x185	26,8	1776	2010	2775	350 MCM
05020G7L010M71	1x240	29,4	2304	2542	3600	450 MCM
05020G7L010M72	1x300	33,4	2880	3210	4500	550 MCM
05020G73020M15	2x1,5	10,9	29	172	45	16
05020G73020M25	2x2,5	11,8	48	208	75	14
05020G73020M40	2x4	13	77	240	120	12
05020G72031M15	3G1,5	12,2	43	155	68	16
05020G73030M25	3x2,5	12,2	72	216	113	14
05020G72031M25	3G2,5	13,2	72	217	113	14
05020G73030M40	3x4	13,6	115	280	180	12
05020G72031M40	3G4	14,3	115	304	180	12
05020G73030M60	3x6	14,3	173	354	270	10
05020G72031M60	3G6	17,4	173	354	270	10
05020G73030M61	3x10	17,4	288	512	450	8
05020G73030M62	3x16	20,3	461	785	720	6
05020G73030M63	3x25	24,2	720	1170	1125	4
05020G73030M64	3x35	26,7	1008	1460	1575	2
05020G73030M65	3x50	31,2	1440	2070	2250	1
05020G73030M66	3x70	36,6	2016	2875	3150	2/0
05020G73030M67	3x95	42,7	2736	3815	4275	3/0
05020G73030M68	3x120	46,5	3456	5010	5400	4/0
05020G73030M69	3x150	52,3	4320	5902	6750	250 MCM
05020G72037M65	3x50+3x25/3	31,2	1680	2312	2250	1
05020G72037M66	3x70+3x25/3	36,6	2352	3280	3150	2/0
05020G72037M67	3x95+3x50/3	45,6	3216	4375	4275	3/0
05020G72037M68	3x120+3x50/3	46,5	4128	5460	5400	4/0
05020G72037M69	3x150+3x70/3	53,9	4992	6945	6750	250 MCM
05020G72037M70	3x185+3x95/3	56,8	6240	8282	8325	350 MCM
05020G72037M71	3x240+3x120/3	-	8064	-	-	450 MCM
05020G72037M72	3x300+3x150/3	74,7	10080	13238	13500	550 MCM

MINING CABLES

FLEXIMINING® (N)SHÖU



ELETTROTEK KABEL® FLEXIMINING® (N)SHÖU 0,6/1 kV

Part no.	No. of cores x cross section n x mm ²	Outer-Ø ca.mm ± 10%	Copper weight kg/km	Cable weight approx. kg/km	Tensile strength N	AWG no.*)
05020G72041M15	4G1,5	12,1	58	212	90	16
05020G72041M25	4G2,5	13,1	96	235	150	14
05020G72041M40	4G4	14,1	154	345	240	12
05020G72041M60	4G6	16,2	230	450	360	10
05020G72041M61	4G10	18,7	384	670	600	8
05020G72041M62	4G16	22,9	614	1030	960	6
05020G72041M63	4G25	26,2	960	1475	1500	4
05020G72041M64	4G35	30,2	1344	1920	2100	2
05020G72041M65	4G50	35,4	1920	2620	3000	1
05020G72041M66	4G70	41,3	2688	3745	4200	2/0
05020G72041M67	4G95	46,6	3648	4820	5700	3/0
05020G72041M68	4G120	52,2	4608	6308	7200	4/0
05020G72041M69	4G150	57,2	5760	7568	9000	250 MCM
05020G72051M15	5G1,5	13	72	252	113	16
05020G72051M25	5G2,5	14	120	303	188	14
05020G72051M40	5G4	16	192	424	300	12
05020G72051M60	5G6	17,4	288	590	450	10
05020G72051M61	5G10	20,3	480	775	750	8
05020G72051M62	5G16	26,1	768	1310	1200	6
05020G72051M63	5G25	31,2	1200	1999	1875	4
05020G70071M15	7G1,5	14	101	272	158	16
05020G70081M15	8G1,5	14,9	115	320	180	16
05020G70071M25	7G2,5	16,8	168	410	225	14
05020G70101M15	10G1,5	16,8	144	420	270	16
05020G70121M15	12G1,5	17,1	173	505	315	16
05020G70141M15	14G1,5	18,1	202	610	427	16
05020G70191M15	19G1,5	20,2	274	405	263	16
05020G70081M25	8G2,5	16,2	192	440	300	14
05020G70101M25	10G2,5	17,1	240	520	375	14
05020G70121M25	12G2,5	18,7	288	570	450	14
05020G70141M25	14G2,5	18,6	336	656	525	14
05020G70181M25	18G2,5	20	432	852	675	14
05020G70191M25	19G2,5	22,5	466	910	712	14
05020G70241M25	24G2,5	23,6	576	1015	900	14
05020G71120M40	12x4	24,1	461	820	720	12
05020G71120M60	12x6	25,2	691	1120	1080	10

Other dimensions and colors available on request.

MINING CABLES

FLEXIMINING® (N)SSHÖU 3E/3E+ST/KON

Rubber-sheathed flexible cable, with copper core screen



ELETTROTEK KABEL® FLEXIMINING® NSSHÖU 3E+ST

ELETTROTEK KABEL® FLEXIMINING® NSSHÖU KON

Construction:

Conductor:	flexible red copper conductor Cl. 5, acc. to IEC 60228, DIN VDE 0295
Insulation:	rubber EPR type 3GI3
Cores color:	acc. to DIN VDE 0293-308, HD 308 S2 3 phase cores: brown-black-gray
Earth conductors:	tinned copper wires laying concentric around each power cores
Inner sheath:	rubber EPR type GM1b
Monitoring conductor (KON):	tinned copper wires laying concentric around inner and outer sheath
Outer sheath:	yellow (similar to RAL 1021), rubber PCP type 5GM5

Resistance:



Self-extinguishing and flame retardant acc. to:
DIN VDE 0482 part 265-2-1
EN 50265-2-1
IEC 60332-1-2



Oil resistance acc. to:
DIN VDE 0473 part 811-2-1
IEC EN 60811-2-1

Technical data:

Nominal voltage:	U ₀ /U 0,6/1 kV
Test voltage:	3 kV
Max. operating voltage:	A.C. U ₀ /U = 0,7/1,2 kV D.C. U ₀ /U = 0,9/1,8 kV
Temperature range:	
<i>Fixed laying:</i>	-40°C up to +80°C
<i>Flexible application:</i>	-25°C up to +80°C
Min. bending radius:	
<i>Fixed laying:</i>	4 x D
<i>Flexible installation:</i>	5 x D
Tensile strength:	
<i>Static:</i>	15 N/mm ²
Insulation resistance:	> 20 MOhm*km

Features:

mining Excavator!

weather, ozone, abrasion and oil resistant

high insulation resistance

resistant against hot penetration

high notch resistance

resistant against oils fat and chemicals

MSHA, GOST-R and WUG approvals on request

for MINIMUM BENDING RADIUS
see pages from 5 to 8 of catalogue

RoHS and CE approval



MINING CABLES

FLEXIMINING® (N)SSHÖU 3E/3E+ST/KON

Rubber-sheathed flexible cable, with copper core screen



NSSHÖU.../3E

Part no.	No. of cores x cross section n x mm ²	Outer-Ø ca.mm ± 10%	Cable weight approx. kg/km	Tensile strenght N	AWG no.*)
05030GY3030M15	3x1,5+3x1,5/3E	13	290	68	16
05030GY3030M25	3x2,5+3x2,5/3E	15	335	113	14
05030GY3030M40	3x4+3x4/3E	17,5	500	180	12
05030GY3030M60	3x6+3x6/3E	19	600	270	10
05030GY3030M61	3x10+3x10/3E	23	885	450	8
05030GY3030M62	3x16+3x16/3E	27	1240	720	6
05030GY3030M63	3x25+3x16/3E	31	1720	1125	4
05030GY3030M64	3x35+3x16/3E	35	2240	1575	2
05030GY3030M65	3x50+3x25/3E	40,5	3160	2250	1
05030GY3030M66	3x70+3x35/3E	45	3960	3150	2/0
05030GY3030M67	3x95+3x50/3E	51	5070	4275	3/0
05030GY3030M68	3x120+3x70/3E	57	6460	5400	4/0
05030GY3030M69	3x150+3x70/3E	63	7590	6750	250 MCM
05030GY3030M70	3x185+3x95/3E	67,5	9330	8325	350 MCM

NSSHÖU.../3E+ST

Part no.	No. of cores x cross section n x mm ²	Outer-Ø ca.mm ± 10%	Cable weight approx. kg/km	Tensile strenght N	AWG no.*)
05040GY3037M25	3x2,5+3x2,5/3E+3x1,5ST	18,5	520	113	14
05040GY3037M40	3x4+3x4/3E+3x1,5ST	19,5	600	180	12
05040GY3037M60	3x6+3x6/3E+3x1,5ST	20	670	270	10
05040GY3037M61	3x10+3x10/3E+3x2,5ST	23,5	1010	450	8
05040GY3037M62	3x16+3x16/3E+3x2,5ST	27	1290	720	6
05040GY3037M63	3x25+3x16/3E+3x2,5ST	31	1780	1125	4
05040GY3037M64	3x35+3x16/3E+3x2,5ST	35	2300	1575	2
05040GY3037M65	3x50+3x25/3E+3x2,5ST	40,5	3200	2250	1
05040GY3037M66	3x70+3x35/3E+3x2,5ST	45	4010	3150	2/0
05040GY3037M67	3x95+3x50/3E+3x2,5ST	51	5100	4275	3/0
05040GY3037M68	3x120+3x70/3E+3x2,5ST	57	6510	5400	4/0
05040GY3037M69	3x150+3x70/3E+3x2,5ST	63	7600	6750	250 MCM
05040GY3037M70	3x185+3x95/3E+3x2,5ST	67,5	9400	8325	350 MCM

NSSHÖU.../KON

Part no.	No. of cores x cross section n x mm ²	Outer-Ø ca.mm ± 10%	Cable weight approx. kg/km	Tensile strenght N	AWG no.*)
05050GY3030M15	3x1,5/1,5KON	12,7	275	68	16
05050GY3030M25	3x2,5/2,5KON	14,3	335	113	14
05050GY3040M60	4x6/6KON	20	657	360	10
05050GY3040M61	4x10/10KON	24,5	1050	600	8
05050GY3050M25	5x2,5/2,5KON	18	490	188	14
05050GY3050M40	5x4/4KON	20	640	300	12
05050GY3050M60	5x6/6KON	22,5	845	450	10

Other dimensions and colors available on request.

FLEXIMINING® (N)SSHCÖU



ELETTROTEK KABEL® FLEXIMINING® NSSHCÖU

Construction:

Conductor:	flexible tinned copper conductor Cl. 5, acc to IEC 60228, DIN VDE 0295
Insulation:	rubber EPR type 3GI3 acc. to DIN VDE 0207
Cores color:	3 white conductors + 3 earth conductors divided in 3 interstices
Stranding:	phase units laid up with earth-conductors in interstices
Inner sheath:	rubber EPR type GM1b, acc. to DIN VDE 0207 part 21
Screen:	tinned copper braid
Outer sheath:	yellow (similar to RAL 1021), rubber PCP type 5GM5

Technical data:

Nominal voltage:	U ₀ /U 0,6/1 kV
Test voltage:	3 kV
Max. operating voltage:	A.C. U ₀ /U = 0,7/1,2 kV D.C. U ₀ /U = 0,9/1,8 kV
Temperature range:	
<i>Fixed laying:</i>	-40°C up to +80°C
<i>Flexible application:</i>	-25°C up to +80°C
<i>In service:</i>	up to +90°C
<i>In short circuit:</i>	up to +250°C
Min. bending radius:	acc. to DIN VDE 0298, Part 3
Tensile strenght:	15 N/mm ²
Max. torsion:	+/- 25°/m

Resistance:



Self-extinguishing and flame retardant acc. to:
DIN VDE 0482 part 265-2-1
EN 50265-2-1
IEC 60332-1-2



Oil resistance acc. to:
DIN VDE 0473 part 811-2-1
IEC EN 60811-2-1

Features:

mining Excavator!

weather, ozone, moisture and water resistant
outdoor/indoor use

possible cold version up to -45°C

MSHA, GOST-R and WUG approvals on request

for MINIMUM BENDING RADIUS
see pages from 5 to 8 of catalogue

RoHS and CE approval



Applications:

For frequency converter controlled drives
in the mining and tunneling

MINING CABLES

FLEXIMINING® (N)SSHCÖU



Part no.	No. of cores x cross section n x mm ²	Outer-Ø ca.mm ± 10%	Cable weight approx. kg/km	Tensile strength N	AWG no.®)
05060GYA037M62	3x16+3G2,5	26,2	1200	720	6
05060GYA037M63	3x25+3G4	30	1700	1125	4
05060GYA037M64	3x35+3G16/3	32,5	2200	1575	2
05060GYA037M65	3x50+3G25/3	38	2800	2250	1
05060GYA037M66	3x70+3G35/3	43	3850	3150	2/0
05060GYA037M67	3x95+3G50/3	47,5	4650	4275	3/0
05060GYA037M68	3x120+3x70/3	51	5800	5400	4/0
05060GYA037M69	3x150+3x70/3	58	7150	6750	250 MCM
05060GYA037M70	3x185+3x95/3	62,5	8500	9200	350 MCM
05060GYA037M71	3x240+3x120/3	68,5	10100	11500	450 MCM

Other dimensions and colors available on request.

MINING CABLES

FLEXIMINING® (N)SSHCGEÖU (V)



ELETTROTEK KABEL® FLEXIMINING® NSSHCGEÖU (V) 0,6/1 kV

Construction:

Conductor:	flexible tinned copper conductor Cl. 5, acc to IEC 60228, DIN VDE 0295
Insulation:	rubber EPR type 3GI3
Outer semi-conductive layer:	semi-conducting rubber compound
Monitoring conductor:	tinned copper wires laying concentric around each control cores
Monitor semi-conductive layer:	semi-conducting rubber compound
Cores color:	acc. to DIN VDE 0293-308, HD 308 S2 3 phase cores: brown-black-gray
Stranding:	phase units laid up with concentric control and monitoring conductors in interstices
Inner sheath:	rubber EPR type GM1b
Earth conductor:	copper/steel wires laying concentric between inner and outer sheath
Outer sheath:	yellow (similar to RAL 1021), rubber PCP type 5GM5

Technical data:

Nominal voltage:	U ₀ /U 0,6/1 kV
Test voltage:	
<i>Power core:</i>	3 kV
<i>Control cores:</i>	2 kV
Max. operating voltage:	A.C. U ₀ /U = 0,7/1,2 kV D.C. U ₀ /U = 0,9/1,8 kV
Temperature range:	
<i>Fixed laying:</i>	-40°C up to +80°C
<i>Flexible application:</i>	-25°C up to +80°C
<i>In service:</i>	up to +90°C
<i>In short circuit:</i>	up to +250°C
Min. bending radius:	acc. to DIN VDE 0298, Part 3 or 2,3 x D (with a tensile strenght of max. 5 N/mm ² , please check tensile loading applications)
Tensile strenght:	15 N/mm ² (please check min. bending radius applications)

Resistance:



Self-extinguishing and flame retardant acc. to:
DIN VDE 0482 part 265-2-1
EN 50265-2-1
IEC 60332-1-2



Oil resistance acc. to:
DIN VDE 0473 part 811-2-1
IEC EN 60811-2-1

Features:

coal-cutting machines!

weather, ozone, and moisture resistant
outdoor/indoor use
very good for monitoring the cables with
appropriate monitoring equipment
MSHA, GOST-R and WUG approvals on request
for MINIMUM BENDING RADIUS
see pages from 5 to 8 of catalogue

RoHS and CE approval



Applications:

coal mining and chain use

FLEXIMINING® (N)SSHCGEÖU (V)



ELETTROTEK KABEL® FLEXIMINING® NSSHCGEÖU (V) 0,6/1 kV

NSSHCGEÖU(V) 0,6/1 kV

Part no.	No. of cores x cross section n x mm ²	Outer-Ø ca.mm ± 10%	Cable weight approx. kg/km	Tensile strenght N	AWG no.*)
05070GY3037M63	3x25/16KON+3x(1,5ST KÖN/1,5 UL KON)	38	2850	1125	4
05070GY3037M64	3x35/16KON+3x(1,5ST KÖN/1,5 UL KON)	43	3070	1575	2
05070GY3037M65	3x50/35KON+3x(1,5ST KÖN/1,5 UL KON)	46	4010	2250	1
05070GY3037M66	3x70/35KON+3x(1,5ST KÖN/1,5 UL KON)	53	4970	3150	2/0
05070GY3037M67	3x95/50KON+3x(1,5ST KÖN/1,5 UL KON)	58	6580	4275	3/0
05070GY3037M68	3x120/70KON+3x(1,5ST KÖN/1,5 UL KON)	61	7600	5400	4/0
05070GY3037M69	3x150/70KON+3x(1,5ST KÖN/1,5 UL KON)	65	9350	6750	250 MCM

Other dimensions and colors available on request.

MINING CABLES

FLEXIMINING® (N)TSKCGEWÖU 1,8/3 kV and 3,6/6 kV



ELETTROTEK KABEL® FLEXIMINING® NTSKCGEWÖU 1,8/3 kV and 3,6/6 kV



Construction:

Conductor:	flexible tinned copper conductor Cl. 5, acc to IEC 60228, DIN VDE 0295
Insulation:	rubber EPR type 3GI3
Monitoring conductor:	tinned copper wires laying concentric around each control cores
Monitor semi-conductive layer:	semi-conducting rubber compound
Cores color:	acc. to DIN VDE 0293-308, HD 308 S2 3 phase cores: brown-black-gray
Stranding:	phase units laid up with concentric control and monitoring conductors in interstices
Inner sheath:	rubber EPR type GM1b
Earth conductor:	copper/steel wires laying concentric between inner and outer sheath
Outer sheath:	red (similar to RAL 3000), rubber PCP type 5GM5

Technical data:

Nominal voltage:	Uo/U 1,8/3 and 3,6/6 kV
Test voltage:	6 kV up to 11 kV
Max. operating voltage 1,8/3 kV:	A.C. Uo/U = 2,1/3,6 kV D.C. Uo/U = 0,9/1,8 kV
Max. operating voltage 3,6/6 kV:	A.C. Uo/U = 4,2/7,2 kV D.C. Uo/U = 5,4/10,8 kV
Temperature range:	
<i>Fixed laying:</i>	-40°C up to +80°C
<i>Flexible application:</i>	-25°C up to +80°C
Min. bending radius:	acc. to DIN VDE 0298, Part 3 or 2,3 x D (with a tensile strenght of max. 5 N/mm ² , please check tensile loading applications)
Tensile strenght:	15 N/mm ² (please check min. bending radius applications)

Resistance:



Self-extinguishing and flame retardant acc. to:
DIN VDE 0482 part 265-2-1
EN 50265-2-1
IEC 60332-1-2



Oil resistance acc. to:
DIN VDE 0473 part 811-2-1
IEC EN 60811-2-1

Features:

coal-cutting machines!
weather, ozone, and moisture resistant
outdoor/indoor use
MSHA, GOST-R and WUG approvals on request
for MINIMUM BENDING RADIUS
see pages from 5 to 8 of catalogue
RoHS approval



Applications:

used in cable chains

MINING CABLES

FLEXIMINING® (N)TSKCGEWÖU 1,8/3 kV and 3,6/6 kV



ELETTROTEK KABEL® FLEXIMINING® NTSKCGEWÖU 1,8/3 kV and 3,6/6 kV

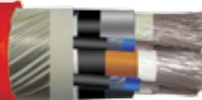

NTSKCGEWÖU 1,8/3 kV (3,6 kV)

Part no.	No. of cores x cross section n x mm ²	Outer-Ø ca.mm ± 10%	Cable weight approx. kg/km	Tensile strength N	AWG no.*)
06010KR3037M64	3x35+3x(1,5 ST KON + 25/3KON) + ÜL KON	45,8	3880	1575	2
06010KR3037M65	3x50+3x(1,5 ST KON + 25/3KON) + ÜL KON	52,7	5085	2250	1
06010KR3037M66	3x70+3x(1,5 ST KON + 35/3KON) + ÜL KON	55,9	6092	3150	2/0
06010KR3037M67	3x95+3x(1,5 ST KON + 50/3KON) + ÜL KON	62,1	7590	4275	3/0

NTSKCGEWÖU 1,8/3 kV (3,6 kV)

Part no.	No. of cores x cross section n x mm ²	Outer-Ø ca.mm ± 10%	Cable weight approx. kg/km	Tensile strength N	AWG no.*)
06020KR3039900	3x50+3x(35+35/3KON) + 2 x (0,75 ST KON) + 1x(2x0,75 ÜL KON)	65,1	7816	3825	1
06020KR3039901	3x70+3x(50+50/3KON) + 2 x (0,75 ST KON) + 1x(2x0,75 ÜL KON)	65,1	8340	5400	2/0
06020KR3039902	3x95+3x(70+70/3KON) + 2 x (0,75 ST KON) + 1x(2x0,75 ÜL KON)	77,1	10307	7425	3/0

NTSKCGEWÖU 3,6/6 kV (7,2 kV)

Part no.	No. of cores x cross section n x mm ²	Outer-Ø ca.mm ± 10%	Cable weight approx. kg/km	Tensile strength N	AWG no.*)
06010MR3037M64	3x35+3x(1,5 ST KON + 25/3KON) + ÜL KON	58,6	5860	1575	2
06010MR3037M65	3x50+3x(1,5 ST KON + 50/3KON) + ÜL KON	59,9	6190	2250	1
06010MR3037M66	3x70+3x(1,5 ST KON + 70/3KON) + ÜL KON	59,7	6800	3150	2/0
06010MR3037M67	3x95+3x(1,5 ST KON + 95/3KON) + ÜL KON	64,3	8170	4275	3/0

NTSKCGEWÖU 3,6/6 kV (7,2 kV)

Part no.	No. of cores x cross section n x mm ²	Outer-Ø ca.mm ± 10%	Cable weight approx. kg/km	Tensile strength N	AWG no.*)
06020MR3039903	3x35+3x(35+35/3KON) + 2 x (0,75 ST KON) + 1x(2x0,75 ÜL KON)	69,1	7690	2700	2
06020MR3039904	3x50+3x(50+50/3KON) + 2 x (0,75 ST KON) + 1x(2x0,75 ÜL KON)	72,8	9210	3825	1
06020MR3039905	3x70+3x(70+70/3KON) + 2 x (0,75 ST KON) + 1x(2x0,75 ÜL KON)	79,4	11430	5400	2/0
06020MR3039906	3x95+3x(95+95/3KON) + 2 x (0,75 ST KON) + 1x(2x0,75 ÜL KON)	88,6	13730	7425	3/0

Other dimensions and colors available on request.

MINING CABLES

FLEXIMINING® (N)SSHCGEÖU (Z) Reinforced version



ELETTROTEK KABEL® NSSHCGEÖU (Z) Reinforced version

Construction:

Conductor:	flexible tinned copper conductor Cl. 5, acc to IEC 60228, DIN VDE 0295
Insulation:	rubber EPR type 3GI3
Monitoring conductor:	tinned copper wires laying concentric around each control cores
Monitor semi-conductive layer:	semi-conducting rubber compound
Stranding:	phase units laid up with concentric control and monitoring conductors in interstices
Cores color:	acc. to DIN VDE 0293-308, HD 308 S2 3 phase cores: brown-black-gray
Stranding:	phase units laid up with concentric control and monitoring conductors in interstices
Inner sheath:	rubber EPR type GM1b
Earth conductor:	copper/steel braid laying concentric between inner and outer sheath
Outer sheath:	yellow (similar to RAL 1021), rubber PCP type 5GM5

Resistance:



Self-extinguishing and flame retardant acc. to:
DIN VDE 0482 part 265-2-1
EN 50265-2-1
IEC 60332-1-2



Oil resistance acc. to:
DIN VDE 0473 part 811-2-1
IEC EN 60811-2-1

Technical data:

Nominal voltage:	U ₀ /U 0,6/1 kV
Test voltage:	3 kV
Max. operating voltage:	A.C. U ₀ /U = 0,7/1,2 kV D.C. U ₀ /U = 0,9/1,8 kV
Temperature range:	
<i>Fixed laying:</i>	-40°C up to +80°C
<i>Flexible application:</i>	-25°C up to +60°C
Min. bending radius:	4 x D

Features:

coal-cutting machines!
weather, ozone, and moisture resistant
outdoor/indoor use
MSHA, GOST-R and WUG approvals on request
for MINIMUM BENDING RADIUS see pages from 5 to 8 of catalogue
RoHS and CE approval



NSSHCGEÖU(Z) 0,6/1 kV

Part no.	No. of cores x cross section n x mm ²	Outer-Ø ca.mm ± 10%	Cable weight approx. kg/km	Braid-tensile strenght N	AWG no.*)
05080GY3037M62	3x16+3x(1,5 ST KON + 16/3 KON)	42,5	2770	55000	6
05080GY3037M63	3x25/16 KON +3x(1,5 ST KON/1,5 ÜL KON)	43,5	3050	55000	4
05080GY3037M64	3x35/16 KON +3x(1,5 ST KON/1,5 ÜL KON)	43,5	3265	55000	2
05080GY3037M65	3x50/25 KON +3x(1,5 ST KON/1,5 ÜL KON)	49,5	4490	80000	1
05080GY3037M66	3x70/35 KON +3x(1,5 ST KON/1,5 ÜL KON)	54,7	5640	80000	2/0
05080GY3037M67	3x95/50 KON +3x(1,5 ST KON/1,5 ÜL KON)	62,5	7230	110000	3/0

Other dimensions and colors available on request.

MINING CABLES

FLEXIMINING® (N)TMCGCWÖU

Flexible single-core, 3,6/6 kV up to 12/24 kV acc. to DIN VDE 0250 part 813

ELETTROTEK KABEL® FLEXIMINING® MEDIUM NTMCGCWÖU

Construction:

Conductor:	flexible tinned copper conductor Cl. 5, acc to IEC 60228, DIN VDE 0295
Inner semi-conductive layer:	semi-conducting rubber compound
Insulation:	rubber EPR type 3GI3
Outer semi-conductive layer:	semi-conducting rubber compound
Core color:	natural color with black semi-conducting compound
Screen:	tinned copper braid
Outer sheath:	red (similar to RAL 3000), rubber PCP type 5GM5

Resistance:



Self-extinguishing and flame retardant acc. to:
DIN VDE 0482 part 265-2-1
EN 50265-2-1
IEC 60332-1-2



Oil resistance acc. to:
DIN VDE 0473 part 811-2-1
IEC EN 60811-2-1

Technical data:

Nominal voltage:	U ₀ /U 3,6/6 up to 12/20 kV
Test voltage:	11 kV up to 29 kV
Temperature range:	
<i>Fixed laying:</i>	-40°C up to +80°C
<i>Flexible application:</i>	-25°C up to +60°C
Temperature on conductor in service:	up to +90°C
<i>in short circuit:</i>	up to +250°C
Min. bending radius:	acc. to DIN VDE 0298, Part 3
Tensile strength:	up to 15 N/mm ²
Max. torsion:	+/- 25°/m

Features:

weather, ozone, moisture and water resistant
outdoor use
UV resistant in the black version
small cable weight
small outer diameter
acc. to standard DIN VDE 0250 part 813
MSHA and WUG approvals on request
for MINIMUM BENDING RADIUS see pages from 5 to 8 of catalogue
RoHS approval



Applications:

single-core cables are used for connection of mobile transformer substations

MINING CABLES

FLEXIMINING® (N)TMCGCWÖU

Flexible single-core, 3,6/6 kV up to 12/24 kV acc. to DIN VDE 0250 part 813

ELETTROTEK KABEL® FLEXIMINING® MEDIUM NTMCGCWÖU

3,6/6 (7,2) kV NTMCGCWÖU

Part no.	No. of cores x cross section n x mm ²	Outer-Ø ca.mm ± 10%	Cable weight approx. kg/km	Tensile strength N	AWG no.®)
06030MRL010M62	1x16/16 KON	20,4	601	240	6
06030MRL010M63	1x25/16 KON	22,4	825	375	4
06030MRL010M64	1x35/16 KON	23,6	882	525	2
06030MRL010M65	1x50/16KON	26,1	1104	750	1
06030MRL010M66	1x70/16KON	28	1346	1050	2/0
06030MRL010M67	1x95/16KON	30	1614	1425	3/0
06030MRL010M68	1x120/16KON	32,7	1983	1800	4/0
06030MRL010M69	1x150/25KON	34,4	2300	2250	250 MCM
06030MRL010M70	1x185/25KON	35,8	2642	2775	350 MCM
06030MRL010M71	1x240/25KON	40,1	3371	3600	450 MCM

6/10 (12) kV NTMCGCWÖU

Part no.	No. of cores x cross section n x mm ²	Outer-Ø ca.mm ± 10%	Cable weight approx. kg/km	Tensile strength N	AWG no.®)
06030QRL010M62	1x16/16 KON	21,4	644	240	6
06030QRL010M63	1x25/16 KON	23,2	791	375	4
06030QRL010M64	1x35/16 KON	24,4	1050	525	2
06030QRL010M65	1x50/16 KON	26,9	1153	750	1
06030QRL010M66	1x70/16 KON	29,5	1399	1050	2/0
06030QRL010M67	1x95/16 KON	30,8	1910	1425	3/0
06030QRL010M68	1x120/16 KON	33,5	2044	1800	4/0
06030QRL010M69	1x150/25 KON	35,2	2364	2250	250 MCM
06030QRL010M70	1x185/25 KON	36,6	2709	2775	350 MCM
06030QRL010M71	1x240/25 KON	40,9	3446	3600	450 MCM

8,7/15 (18) kV NTMCGCWÖU

Part no.	No. of cores x cross section n x mm ²	Outer-Ø ca.mm ± 10%	Cable weight approx. kg/km	Tensile strength N	AWG no.®)
06030SRL010M62	1x16/16 KON	23,6	760	240	6
06030SRL010M63	1x25/16 KON	26,3	954	375	4
06030SRL010M64	1x35/16 KON	27,9	1101	525	2
06030SRL010M65	1x50/16 KON	29,5	1304	750	1
06030SRL010M66	1x70/16 KON	32	1623	1050	2/0
06030SRL010M67	1x95/16 KON	34	1912	1425	3/0
06030SRL010M68	1x120/16 KON	35,7	2219	1800	4/0
06030SRL010M69	1x150/25 KON	38,4	2637	2250	250 MCM
06030SRL010M70	1x185/25 KON	39,7	2995	2775	350 MCM
06030SRL010M71	1x240/25 KON	42	3658	3600	450 MCM

12/20 (24) kV NTMCGCWÖU

Part no.	No. of cores x cross section n x mm ²	Outer-Ø ca.mm ± 10%	Cable weight approx. kg/km	Tensile strength N	AWG no.®)
06030URL010M62	1x16/16 KON	27,5	971	240	6
06030URL010M63	1x25/16 KON	28,7	1090	375	4
06030URL010M64	1x35/16 KON	29,9	1236	525	2
06030URL010M65	1x50/16 KON	32,5	1680	750	1
06030URL010M66	1x70/16 KON	34	1776	1050	2/0
06030URL010M67	1x95/16 KON	36	2170	1425	3/0
06030URL010M68	1x120/16 KON	38,7	2481	1800	4/0
06030URL010M69	1x150/25 KON	40,4	3020	2250	250 MCM
06030URL010M70	1x185/25 KON	41,8	3182	2775	350 MCM
06030URL010M71	1x240/25 KON	45,1	3870	3600	450 MCM

Other dimensions and colors available on request.

MINING CABLES

FLEXIMINING® (N)TMCWÖU

Flexible single-core, 6/10 kV up to 20/35 kV acc. to DIN VDE 0250 part 813

ELETTROTEK KABEL® FLEXIMINING® MEDIUM NTMCWÖU

Construction:

Conductor:	flexible tinned copper conductor Cl. 5, acc. to IEC 60228, DIN VDE 0295
Inner semi-conductive layer:	semi-conducting rubber compound
Insulation:	rubber EPR type 3GI3
Outer semi-conductive layer:	semi-conducting rubber compound
Core color:	natural color with black semi-conducting compound
Screen:	tinned copper wires
Outer sheath:	red (similar to RAL 3000), rubber PCP type 5GM3 acc. to DIN VDE 0207 part 21

Technical data:

Nominal voltage:	U ₀ /U 6/10 up to 20/35 kV
Test voltage:	17 kV up to 50 kV
Temperature range:	
<i>Fixed laying:</i>	-40°C up to +80°C
<i>Flexible application:</i>	-25°C up to +80°C
Temperature on conductor in service:	up to +90°C
Min. bending radius:	
<i>Fixed laying:</i>	5 x D
<i>Flexible installation:</i>	10 x D

Resistance:



Self-extinguishing and flame retardant acc. to:

DIN VDE 0482 part 265-2-1
EN 50265-2-1
IEC 60332-1-2



Oil resistance acc. to:

DIN VDE 0473 part 811-2-1
IEC EN 60811-2-1

Features:

- UV resistant (black version)
- small cable weight
- small outer diameter
- very small bending radius
- acc. to standard DIN VDE 0250 part 813
- MSHA and WUG approvals on request
- for MINIMUM BENDING RADIUS see pages from 5 to 8 of catalogue
- RoHS approval



MINING CABLES

FLEXIMINING® (N)TMCWÖU

Flexible single-core, 6/10 kV up to 20/35 kV acc. to DIN VDE 0250 part 813

ELETTROTEK KABEL® FLEXIMINING® MEDIUM NTMCWÖU

6/10 (12) kV NTMCWÖU

Part no.	No. of cores x cross section n x mm ²	Outer-Ø ca.mm ± 10%	Cable weight approx. kg/km	AWG no.®)
06040QRL010M62	1x16/16	22,3	765	6
06040QRL010M63	1x25/16	23,8	920	4
06040QRL010M64	1x35/16	24,8	1050	2
06040QRL010M65	1x50/16	27,3	1265	1
06040QRL010M66	1x70/16	28,8	1540	2/0
06040QRL010M67	1x95/16	30,7	1780	3/0
06040QRL010M68	1x120/16	33,9	2185	4/0
06040QRL010M69	1x150/25	35,2	2560	250 MCM
06040QRL010M70	1x185/25	37,1	2910	350 MCM
06040QRL010M71	1x240/25	41,3	3595	450 MCM
06040QRL010M72	1x300/25	43,2	4290	550 MCM
06040QRL010M73	1x400/35	46,4	5130	750 MCM
06040QRL010M74	1x500/35	49,3	5960	950 MCM
06040QRL010M75	1x630/35	53,3	7870	1200 MCM

12/20 (24) kV NTMCWÖU

Part no.	No. of cores x cross section n x mm ²	Outer-Ø ca.mm ± 10%	Cable weight approx. kg/km	AWG no.®)
06040URL010M63	1x25/16	28,8	1190	4
06040URL010M64	1x35/16	29,7	1330	2
06040URL010M65	1x50/16	31,8	1570	1
06040URL010M66	1x70/16	34,2	1930	2/0
06040URL010M67	1x95/16	36,1	2200	3/0
06040URL010M68	1x120/16	38,3	2470	4/0
06040URL010M69	1x150/25	40,2	3000	250 MCM
06040URL010M70	1x185/25	42,5	3360	350 MCM
06040URL010M71	1x240/25	45,2	3995	450 MCM
06040URL010M72	1x300/25	48,3	4775	550 MCM
06040URL010M73	1x400/35	52,3	6115	750 MCM
06040URL010M74	1x500/35	56,2	7020	950 MCM
06040URL010M75	1x630/35	60,3	8190	1200 MCM

14/25 (30) kV NTMCWÖU

Part no.	No. of cores x cross section n x mm ²	Outer-Ø ca.mm ± 10%	Cable weight approx. kg/km	AWG no.®)
06040WRL010M63	1x25/16	30,7	1310	4
06040WRL010M72	1x300/25	49,2	4910	550 MCM

18/30 (36) kV NTMCWÖU

Part no.	No. of cores x cross section n x mm ²	Outer-Ø ca.mm ± 10%	Cable weight approx. kg/km	AWG no.®)
06040XRL010M65	1x50/16	35,2	1880	1

20/35 (42) kV NTMCWÖU

Part no.	No. of cores x cross section n x mm ²	Outer-Ø ca.mm ± 10%	Cable weight approx. kg/km	AWG no.®)
06040YRL010M65	1x50/16	40,4	2300	1
06040YRL010M67	1x95/16	44,2	2910	3/0
06040YRL010M69	1x150/25	46,6	3615	250 MCM
06040YRL010M71	1x240/25	51,9	5010	450 MCM

Other dimensions and colors available on request.

FLEXIMINING® MEDIUM NTMCWÖU WATER PROOF

Flexible single-core, 6/10 kV up to 12/20 kV acc. to DIN VDE 0250 part 813

ELETTROTEK KABEL® FLEXIMINING® MEDIUM NTMCWÖU WATER PROOF



Construction:

Conductor:	flexible tinned copper conductor Cl. 5, acc to IEC 60228, DIN VDE 0295
Inner semi-conductive layer:	semi-conducting rubber compound
Insulation:	rubber HEPR type SHS
Outer semi-conductive layer:	semi-conducting rubber compound
Core color:	natural color with black semi-conducting compound
Inner sheath:	special water resistant compound
Screen:	tinned copper wires
Outer sheath:	blue (similar to RAL 5015), rubber PCP type 5GM3 acc. to DIN VDE 0207 part 21

Features:

- water proof approved
- very good water resistant
- Installation in water up to 500 mt. depth
- small cable weight
- small outer diameter
- very small bending radius
- acc. to standard DIN VDE 0250 part 813
- MSHA and WUG approvals on request
- for MINIMUM BENDING RADIUS see pages from 5 to 8 of catalogue
- RoHS approval



Technical data:

Nominal voltage:	U ₀ /U 6/10 up to 12/20 kV
Test voltage:	17 kV up to 29 kV
Temperature range:	
<i>Fixed laying:</i>	-40°C up to +80°C
<i>Flexible application:</i>	-25°C up to +80°C
Temperature on conductor in service:	up to +90°C
Min. bending radius:	
<i>Fixed laying:</i>	5 x D
<i>Flexible installation:</i>	10 x D

MINING CABLES

FLEXIMINING® MEDIUM NTMCWÖU WATER PROOF

Flexible single-core, 6/10 kV up to 12/20 kV acc. to DIN VDE 0250 part 813



6/10 (12) kV NTMCWÖU WATER PROOF

Part no.	No. of cores x cross section n x mm ²	Outer-Ø ca.mm ± 10%	Cable weight approx. kg/km	AWG no.)*
06140QBL010M62	1x16/16	22	760	6
06140QBL010M63	1x25/16	23,5	910	4
06140QBL010M64	1x35/16	24,5	1040	2
06140QBL010M65	1x50/16	27	1260	1
06140QBL010M66	1x70/16	28,5	1530	2/0
06140QBL010M67	1x95/16	30,5	1770	3/0
06140QBL010M68	1x120/16	33,5	2180	4/0
06140QBL010M69	1x150/25	35	2550	250 MCM
06140QBL010M70	1x185/25	37	2900	350 MCM
06140QBL010M71	1x240/25	41	3590	450 MCM
06140QBL010M74	1x500/35	49	5950	950 MCM
06140QBL010M75	1x630/35	53,5	7860	1200 MCM

12/20 (24) kV NTMCWÖU WATER PROOF

Part no.	No. of cores x cross section n x mm ²	Outer-Ø ca.mm ± 10%	Cable weight approx. kg/km	AWG no.)*
06140UBL010M63	1x25/16	28	1180	4
06140UBL010M64	1x35/16	29,5	1320	2
06140UBL010M65	1x50/16	31,5	1560	1
06140UBL010M66	1x70/16	34	1920	2/0
06140UBL010M67	1x95/16	36	2190	3/0
06140UBL010M68	1x120/16	38	2460	4/0
06140UBL010M69	1x150/25	40	2990	250 MCM
06140UBL010M70	1x185/25	42	3350	350 MCM
06140UBL010M71	1x240/25	45	3990	450 MCM

Other dimensions and colors available on request.

MINING CABLES

FLEXIMINING® MEDIUM NTMCWÖU COLD

Flexible single-core, 6/10 kV up to 26/45 kV acc. to DIN VDE 0250 part 813

ELETTROTEK KABEL® FLEXIMINING® MEDIUM NTMCWÖU COLD

Construction:

Conductor:	flexible tinned copper conductor Cl. 5, acc to IEC 60228, DIN VDE 0295
Inner semi-conductive layer:	semi-conducting rubber compound
Insulation:	rubber EPR type 3GI3
Outer semi-conductive layer:	semi-conducting rubber compound
Core color:	natural color with black semi-conducting compound
Screen:	tinned copper wires
Outer sheath:	black (similar to RAL 9005), rubber PCP type 5GM3 acc. to DIN VDE 0207 part 21

Technical data:

Nominal voltage:	U ₀ /U 6/10 up to 26/45 kV
Test voltage:	17 kV up to 87 kV
Temperature range:	
<i>Fixed laying:</i>	-50°C up to +80°C
<i>Flexible application:</i>	-50 °C up to +80°C
Temperature on conductor in service:	up to +90°C
Min. bending radius:	
<i>Fixed laying:</i>	5 x D
<i>Flexible installation:</i>	10 x D

Resistance:



Self-extinguishing and flame retardant acc. to:
DIN VDE 0482 part 265-2-1
EN 50265-2-1
IEC 60332-1-2



Oil resistance acc. to:
DIN VDE 0473 part 811-2-1
IEC EN 60811-2-1

Features:

UV resistant
small cable weight
small outer diameter
very small bending radius
acc. to standard DIN VDE 0250 part 813
MSHA and WUG approvals on request
for MINIMUM BENDING RADIUS see pages from 5 to 8 of catalogue
RoHS approval



MINING CABLES

FLEXIMINING® MEDIUM NTMCWÖU COLD

Flexible single-core, 6/10 kV up to 26/45 kV acc. to DIN VDE 0250 part 813

ELETTROTEK KABEL® FLEXIMINING® MEDIUM NTMCWÖU COLD

6/10 (12) kV NTMCWÖU

Part no.	No. of cores x cross section n x mm ²	Outer-Ø ca.mm ± 10%	Cable weight approx. kg/km	AWG no.®)
06050Q7L010M62	1x16/16	22,3	765	6
06050Q7L010M63	1x25/16	23,8	920	4
06050Q7L010M64	1x35/16	24,8	1050	2
06050Q7L010M65	1x50/16	27,3	1265	1
06050Q7L010M66	1x70/16	28,8	1540	2/0
06050Q7L010M67	1x95/16	30,7	1780	3/0
06050Q7L010M68	1x120/16	33,9	2185	4/0
06050Q7L010M69	1x150/25	35,2	2560	250 MCM
06050Q7L010M70	1x185/25	37,1	2910	350 MCM
06050Q7L010M71	1x240/25	41,3	3595	450 MCM
06050Q7L010M72	1x300/25	43,2	4290	550 MCM
06050Q7L010M73	1x400/35	46,4	5130	750 MCM
06050Q7L010M74	1x500/35	49,3	5960	950 MCM
06050Q7L010M75	1x630/35	53,3	7870	1200 MCM

12/20 (24) kV NTMCWÖU

Part no.	No. of cores x cross section n x mm ²	Outer-Ø ca.mm ± 10%	Cable weight approx. kg/km	AWG no.®)
06050U7L010M63	1x25/16	28,8	1190	4
06050U7L010M64	1x35/16	29,7	1330	2
06050U7L010M65	1x50/16	31,8	1570	1
06050U7L010M66	1x70/16	34,2	1930	2/0
06050U7L010M67	1x95/16	36,1	2200	3/0
06050U7L010M68	1x120/16	38,3	2470	4/0
06050U7L010M69	1x150/25	40,2	3000	250 MCM
06050U7L010M70	1x185/25	42,5	3360	350 MCM
06050U7L010M71	1x240/25	45,2	3995	450 MCM
06050U7L010M72	1x300/25	48,3	4775	550 MCM
06050U7L010M73	1x400/35	52,3	6115	750 MCM
06050U7L010M74	1x500/35	56,2	7020	950 MCM
06050U7L010M75	1x630/35	60,3	8190	1200 MCM

14/25 (30) kV NTMCWÖU

Part no.	No. of cores x cross section n x mm ²	Outer-Ø ca.mm ± 10%	Cable weight approx. kg/km	AWG no.®)
06050W7L010M63	1x25/16	30,7	1310	4
06050W7L010M72	1x300/25	49,2	4910	550 MCM

18/30 (36) kV NTMCWÖU

Part no.	No. of cores x cross section n x mm ²	Outer-Ø ca.mm ± 10%	Cable weight approx. kg/km	AWG no.®)
06050X7L010M65	1x50/16	35,2	1880	1

20/35 (42) kV NTMCWÖU

Part no.	No. of cores x cross section n x mm ²	Outer-Ø ca.mm ± 10%	Cable weight approx. kg/km	AWG no.®)
06050Y7L010M67	1x95/16	44,2	2910	3/0
06050Y7L010M69	1x150/25	46,6	3615	250 MCM
06050Y7L010M71	1x240/25	51,9	5010	450 MCM

26/45 (54) kV NTMCWÖU

Part no.	No. of cores x cross section n x mm ²	Outer-Ø ca.mm ± 10%	Cable weight approx. kg/km	AWG no.®)
06050Z7L010M69	1x150/25	54	4600	250 MCM

Other dimensions and colors available on request.

FLEXIMINING® MEDIUM NTMCWÖU

Flexible single-core, 26/45 kV acc. to DIN VDE 0250 part 813



Construction:

Conductor:	flexible tinned copper conductor Cl. 5, acc. to IEC 60228, DIN VDE 0295
Inner semi-conductive layer:	semi-conducting rubber compound
Insulation:	rubber EPR special compound
Outer semi-conductive layer:	semi-conducting rubber compound
Core color:	natural color with black semi-conducting compound
Screen:	tinned copper wires
Outer sheath:	red (similar to RAL 3000), halogen-free compound acc. to DIN VDE 0207 part 24

Technical data:

Nominal voltage:	U ₀ /U 26/45 kV
Test voltage:	87 kV
Temperature range:	
<i>Fixed laying:</i>	-40°C up to +80°C
<i>Flexible application:</i>	-25 °C up to +80°C
Temperature on conductor in service:	up to +90°C
Min. bending radius:	
<i>Fixed laying:</i>	5 x D
<i>Flexible installation:</i>	10 x D
Tensile strength:	up to 15 N/mm ²

Features:

- small cable weight
- small outer diameter
- acc. to standard DIN VDE 0250 part 813
- MSHA and WUG approvals on request
- for MINIMUM BENDING RADIUS see pages from 5 to 8 of catalogue
- RoHS approval



Resistance:

Self-extinguishing, flame retardant and no flame propagation acc. to:

DIN VDE 0482 part 265-2-1
EN 50265-2-1
IEC 60332-1-2
DIN VDE 0482 part 265-5-2
EN 50265-5-2
IEC 60332-3C
NF C 32-070 C1
NF F 16-101 Fo
BS 6853 cat. 1b



Halogen free acc. to:

acc. to DIN VDE 0482, part 267-2-1
EN 50267-2-1
IEC 60754-1
IEC 60884-2



Corrosiveness of conflagration gases acc. to:

acc. to DIN VDE 0482, part 267-2-2
EN 50267-2-2
IEC 60754-2



Low smoke density acc. to:

DIN VDE 0482 part. 268-1-2
EN 50268-1-2
IEC 61034-1-2
BS 6853 cat. 1b



Toxicity acc. to:

BS 6853 cat. 1b
EN 50305
NF F 16-101 Fo



Ozone resistance acc. to:

IEC 92-350



Chemical resistance acc. to:

EN 60721-3-5, class 5C2



Mechanical stress acc. to:

EN 61373 cat. 1, class B



Humidity resistance acc. to:

acc. to EN 50125-1



Biological substance resistance acc. to:

acc. to EN 60721-3-5, class 5B2



Fluid resistance acc. to:

EN 60721-3-5, class 5F3



Railway network stability acc. to:

for voltage pulses IEC 61287-1
for sustained over voltage,
IEC EN 50163, appendix A, Zone C

MINING CABLES

FLEXIMINING® MEDIUM NTMCWÖU

Flexible single-core, 26/45 kV acc. to DIN VDE 0250 part 813



ELETTROTEK KABEL® FLEXIMINING® MEDIUM NTMCWÖU

26/34 kV NTMCWÖU

Part no.	No. of cores x cross section n x mm ²	Outer-Ø ca. mm ± 10%	Cable weight approx. kg/km	AWG no.)*
06060ZRL010M65	1x50/16	37	1900	1
06060ZRL010M66	1x70/16	39	2400	2/0
06060ZRL010M67	1x95/16	41	2700	3/0
06060ZRL010M68	1x120/16	43	3000	4/0
06060ZRL010M69	1x150/25	45	3700	250 MCM
06060ZRL010M70	1x185/25	47	4200	350 MCM
06060ZRL010M71	1x240/25	50	4500	450 MCM
06060ZRL010M73	1x400/35	56	6400	750 MCM
06060ZRL010M74	1x500/25	59,5	7400	950 MCM
06060ZRL010M75	1x630/35	64	9200	1200 MCM

Other dimensions and colors available on request.

MINING CABLES

FLEXIMINING® MEDIUM NTMCWÖU

Flexible single-core, 76/132-138 kV acc. to DIN VDE 0250 part 813

ELETTROTEK KABEL® FLEXIMINING® MEDIUM NTMCWÖU

Construction:

Conductor:	flexible tinned copper conductor Cl. 5, acc. to IEC 60228, DIN VDE 0295
Inner semi-conductive layer:	semi-conducting rubber compound
Insulation:	rubber EPR special compound
Outer semi-conductive layer:	semi-conducting rubber compound
Core color:	natural color with black semi-conducting compound
Screen:	tinned copper wires
Outer sheath:	red (similar to RAL 3000), rubber PCP type 5GM3 acc. to DIN VDE 0207 part 21

Resistance:



Self-extinguishing and flame retardant acc. to:
DIN VDE 0482 part 265-2-1
EN 50265-2-1
IEC 60332-1-2



Oil resistance acc. to:
DIN VDE 0473 part 811-2-1
IEC EN 60811-2-1

Technical data:

Nominal voltage:	U ₀ /U 76/132-138 (145) kV
Temperature range:	
<i>Fixed laying:</i>	-50°C up to +80°C
<i>Flexible application:</i>	-40 °C up to +80°C
Temperature on conductor in service:	up to +90°C
<i>in short-circuit:</i>	up to +250°C
Temperature on screen:	
<i>in short-circuit:</i>	up to +350°C
Min. bending radius:	
<i>Fixed laying:</i>	5 x D
<i>Flexible installation:</i>	10 x D

Features:

small cable weight
small outer diameter
very small bending radius
possible cold version -50°C
acc. to DIN VDE 0250 part 813, IEC 60840
MSHA and WUG approvals on request
for MINIMUM BENDING RADIUS see pages from 5 to 8 of catalogue
RoHS approval



76/132-138 (145) kV NTMCWÖU

Part no.	No. of cores x cross section n x mm ²	Outer-Ø ca.mm ± 10%	Cable weight approx. kg/km	AWG no.*)
06040ORL010M71	1x240/105	70,7	7200	450 MCM

Other dimensions and colors available on request.

MINING CABLES

FLEXIMINING® MEDIUM F-(N)TSCGEWÖU



Construction:

Conductor:	flexible red copper conductor Cl. 5, acc to IEC 60228, DIN VDE 0295
Inner semi-conductive layer:	semi-conducting rubber compound
Insulation:	rubber EPR compound
Outer semi-conductive layer:	semi-conducting compound
Earth conductor:	flexible red copper conductor Cl. 5, acc to IEC 60228, DIN VDE 0295
Earth semi-conductive layer:	semi-conducting compound
Cores color:	Power: natural color with black semi-conducting compound Earth: black semi-conducting compound
Stranding:	phase units laid up with earth-conductors in interstices
Inner sheath:	rubber EPR compound
Outer sheath:	red (similar to RAL 3000), rubber PCP compound

Technical data:

Nominal voltage:	U _o /U 3,6/6 kV up to 18/30 kV
Max. permissible operating voltage in A.C. systems:	U _o U 4,2/7,2 kV up to 20,8/36 kV
Max. permissible operating voltage in D.C. systems:	U _o U 5,4/10,8 kV up to 27/54 kV
Test voltage:	11 kV up to 43 kV
Temperature range:	
<i>Fixed laying:</i>	-40°C up to +80°C
<i>Flexible application:</i>	-25 °C up to +60°C
Temperature on conductor in service:	up to +90°C
<i>in short-circuit:</i>	up to +250°C
Min. bending radius:	acc. to DIN VDE 0298, Part 3
Tensile strength:	20 N/mm ²
Max speed (main application):	100 m/min
Max. torsion:	± 100°/m

Resistance:



Self-extinguishing and flame retardant acc. to:

DIN VDE 0482 part 265-2-1

EN 50265-2-1

IEC 60332-1-2



Oil resistance acc. to:

DIN VDE 0473 part 811-2-1

IEC EN 60811-2-1

Features:

conveyor belts!

UV, ozone, and moisture resistant

outdoor use

very flexible

acc. to DIN VDE 0250 part 813

GOST-R and WUG approvals on request

for SPEEDS and MINIMUM BENDING RADIUS see pages from 2 to 8 of catalogue

Applications:

For the conveyor and materials handling equipment

MINING CABLES

FLEXIMINING® MEDIUM F-(N)TSCGEWÖU



3,6/6 (7,2) kV F-(N)TSCGEWÖU

Part no.	No. of cores x cross section n x mm ²	Outer-Ø ca.mm ± 10%	Copper weight kg/km	Cable weight approx. kg/km	Tensile strength N	AWG no.)*
06070MR1037M63	3x25 + 3x25/3	38,2	960	2315	1125	4
06071MR1037M63	3x25 + 3x50/3	42,1	1200	2875	1125	4
06070MR1037M64	3x35 + 3x25/3	42	1248	2868	1575	2
06071MR1037M64	3x35 + 3x50/3	43,8	1488	3230	1575	2
06070MR1037M65	3x50 + 3x25/3	45,3	1680	3515	2250	1
06071MR1037M65	3x50 + 3x50/3	45,3	1920	3655	2250	1
06070MR1037M66	3x70 + 3x35/3	48,5	2256	4368	3150	2/0
06071MR1037M66	3x70 + 3x50/3	51,7	2496	5018	3150	2/0
06070MR1037M67	3x95 + 3x50/3	54,6	3216	5547	4275	3/0
06070MR1037M68	3x120 + 3x70/3	57,9	4128	6680	5400	4/0
06070MR1037M69	3x150 + 3x70/3	63	4992	8015	6750	250 MCM
06070MR1037M70	3x185 + 3x95/3	66	6240	9310	8325	350 MCM
06070MR1037M71	3x240 + 3x120/3	74,1	8064	11966	10800	450 MCM
06070MR1037M72	3x300 + 3x150/3	79,3	10080	14245	13500	550 MCM

6/10 (12) kV F-(N)TSCGEWÖU

Part no.	No. of cores x cross section n x mm ²	Outer-Ø ca.mm ± 10%	Copper weight kg/km	Cable weight approx. kg/km	Tensile strength N	AWG no.)*
06070QR1037M63	3x25 + 3x25/3	40,5	960	2510	1125	4
06071QR1037M63	3x25 + 3x50/3	42,9	1200	2915	1125	4
06070QR1037M64	3x35 + 3x25/3	43,3	1248	2987	1575	2
06071QR1037M64	3x35 + 3x50/3	45,1	1488	3340	1575	2
06070QR1037M65	3x50 + 3x25/3	46,6	1680	3635	2250	1
06071QR1037M65	3x50 + 3x50/3	46,6	1920	3740	2250	1
06070QR1037M66	3x70 + 3x35/3	53,1	2477	4915	3150	2/0
06071QR1037M66	3x70 + 3x50/3	53,1	2640	5140	3150	2/0
06070QR1037M67	3x95 + 3x50/3	55,5	3216	5721	4275	3/0
06070QR1037M68	3x120 + 3x70/3	59,2	4128	6869	5400	4/0
06070QR1037M69	3x150 + 3x70/3	64,3	4992	8201	6750	250 MCM
06070QR1037M70	3x185 + 3x95/3	67,3	6240	9515	8325	350 MCM
06070QR1037M71	3x240 + 3x120/3	75,4	8064	12180	10800	450 MCM
06070QR1037M72	3x300 + 3x150/3	80,6	10080	14515	13500	550 MCM

8,7/15 (18) kV F-(N)TSCGEWÖU

Part no.	No. of cores x cross section n x mm ²	Outer-Ø ca.mm ± 10%	Copper weight kg/km	Cable weight approx. kg/km	Tensile strength N	AWG no.)*
06070SR1037M63	3x25 + 3x25/3	44	960	2857	1125	4
06071SR1037M63	3x25 + 3x50/3	45,7	1200	3218	1125	4
06070SR1037M64	3x35 + 3x25/3	46,8	1248	3348	1575	2
06071SR1037M64	3x35 + 3x50/3	46,8	1488	3466	1575	2
06070SR1037M65	3x50 + 3x25/3	51,4	1680	4188	2250	1
06071SR1037M65	3x50 + 3x50/3	51,4	1920	4312	2250	1
06070SR1037M66	3x70 + 3x35/3	54,7	2256	5100	3150	2/0
06071SR1037M66	3x70 + 3x50/3	54,7	2496	5320	3150	2/0
06070SR1037M67	3x95 + 3x50/3	59	3216	6175	4275	3/0
06070SR1037M68	3x120 + 3x70/3	64,1	4128	7540	5400	4/0
06070SR1037M69	3x150 + 3x70/3	67,7	4992	8715	6750	250 MCM
06070SR1037M70	3x185 + 3x95/3	70,7	6240	10035	8325	350 MCM
06070SR1037M71	3x240 + 3x120/3	78,8	8064	12738	10800	450 MCM
06070SR1037M72	3x300 + 3x150/3	84	10080	15118	13500	550 MCM

MINING CABLES

FLEXIMINING® MEDIUM F-(N)TSCGEWÖU



12/20 (24) kV F-(N)TSCGEWÖU

Part no.	No. of cores x cross section n x mm ²	Outer-Ø ca.mm ± 10%	Copper weight kg/km	Cable weight approx. kg/km	Tensile strength N	AWG no.*)
06070UR1037M63	3x25 + 3x25/3	47	960	3140	1125	4
06071UR1037M63	3x25 + 3x50/3	48,7	1200	3312	1125	4
06070UR1037M64	3x35 + 3x25/3	49,8	1248	3672	1575	2
06071UR1037M64	3x35 + 3x50/3	53	1488	3823	1575	2
06070UR1037M65	3x50 + 3x25/3	54,5	1680	4530	2250	1
06071UR1037M65	3x50 + 3x50/3	54,5	1920	4675	2250	1
06070UR1037M66	3x70 + 3x35/3	57,7	2256	5466	3150	2/0
06071UR1037M66	3x70 + 3x50/3	60	2496	5701	3150	2/0
06070UR1037M67	3x95 + 3x50/3	63,4	3216	6780	4275	3/0
06070UR1037M68	3x120 + 3x70/3	67,1	4128	7985	5400	4/0
06070UR1037M69	3x150 + 3x70/3	70,7	4992	9180	6750	250 MCM
06070UR1037M70	3x185 + 3x95/3	75,2	6240	10791	8325	350 MCM
06070UR1037M71	3x240 + 3x120/3	81,8	8064	13290	10800	450 MCM
06070UR1037M72	3x300 + 3x150/3	89,8	10080	16080	13500	550 MCM

14/25 (30) kV F-(N)TSCGEWÖU

Part no.	No. of cores x cross section n x mm ²	Outer-Ø ca.mm ± 10%	Copper weight kg/km	Cable weight approx. kg/km	Tensile strength N	AWG no.*)
06070WR1037M63	3x25 + 3x25/3	50,3	960	3770	1125	4
06071WR1037M63	3x25 + 3x50/3	52,3	1200	3890	1125	4
06070WR1037M64	3x35 + 3x25/3	55,1	1248	4278	1575	2
06071WR1037M64	3x35 + 3x50/3	55,1	1488	4420	1575	2
06070WR1037M65	3x50 + 3x25/3	58,3	1680	5015	2250	1
06071WR1037M65	3x50 + 3x50/3	58,3	1920	5165	2250	1
06070WR1037M66	3x70 + 3x35/3	63	2256	6180	3150	2/0
06071WR1037M66	3x70 + 3x50/3	63	2496	6422	3150	2/0
06070WR1037M67	3x95 + 3x50/3	67,3	3216	7352	4275	3/0
06070WR1037M68	3x120 + 3x70/3	71	4128	8568	5400	4/0
06070WR1037M69	3x150 + 3x70/3	76	4992	10015	6750	250 MCM
06070WR1037M70	3x185 + 3x95/3	79	6240	11420	8325	350 MCM
06070WR1037M71	3x240 + 3x120/3	87,5	8064	14410	10800	450 MCM
06070WR1037M72	3x300 + 3x150/3	92,7	10080	16873	13500	550 MCM

18/30 (36) kV F-(N)TSCGEWÖU

Part no.	No. of cores x cross section n x mm ²	Outer-Ø ca.mm ± 10%	Copper weight kg/km	Cable weight approx. kg/km	Tensile strength N	AWG no.*)
06070XR1037M63	3x25 + 3x25/3	55,7	960	4168	1125	4
06071XR1037M63	3x25 + 3x50/3	55,7	1200	4310	1125	4
06070XR1037M64	3x35 + 3x25/3	58,6	1248	4720	1575	2
06071XR1037M64	3x35 + 3x50/3	58,6	1488	4860	1575	2
06070XR1037M65	3x50 + 3x25/3	63,2	1680	5710	2250	1
06071XR1037M65	3x50 + 3x50/3	63,2	1920	5845	2250	1
06070XR1037M66	3x70 + 3x35/3	66,6	2256	6692	3150	2/0
06071XR1037M66	3x70 + 3x50/3	66,6	2496	6912	3150	2/0
06070XR1037M67	3x95 + 3x50/3	70,7	3216	7865	4275	3/0
06070XR1037M68	3x120 + 3x70/3	75,8	4128	9385	5400	4/0
06070XR1037M69	3x150 + 3x70/3	79,5	4992	10670	6750	250 MCM
06070XR1037M70	3x185 + 3x95/3	82,5	6240	12070	8325	350 MCM
06070XR1037M71	3x240 + 3x120/3	91	8064	15080	10800	450 MCM
06070XR1037M72	3x300 + 3x150/3	97,2	10080	17815	13500	550 MCM

Other dimensions and colors available on request.

MINING CABLES

FLEXIMINING® MEDIUM F-(N)TSCGEWÖU

Optical fiber



Construction:

Conductor:	flexible red copper conductor Cl. 5, acc to IEC 60228, DIN VDE 0295
Inner semi-conductive layer:	semi-conducting rubber compound
Insulation:	rubber EPR compound
Outer semi-conductive layer:	semi-conducting compound
Earth conductor:	flexible red copper conductor Cl. 5, acc to IEC 60228, DIN VDE 0295
Earth semi-conductive layer:	semi-conducting compound
Cores color:	Power: natural color with black semi-conducting compound Earth: black semi-conducting compound
Optical fibers element:	6 fiber-optics laying in 6 free tubes (1 fibers per tube)
Stranding:	phase units laid up with earth-conductors and fiber optics in interstices
Inner sheath:	rubber EPR compound
Outer sheath:	red (similar to RAL 3000), rubber PCP compound

Technical data:

Nominal voltage:	U _o /U 3,6/6 kV up to 20/35 kV
Max. permissible operating voltage in A.C. systems:	U _o U 4,2/7,2 kV up to 24,3/42 kV
Max. permissible operating voltage in D.C. systems:	U _o U 5,4/10,8 kV up to 31,5/63 kV
Test voltage:	11 kV up to 50 kV
Temperature range:	
<i>Fixed laying:</i>	-40°C up to +80°C
<i>Flexible application:</i>	-25 °C up to +60°C
Temperature on conductor	
<i>in service:</i>	up to +90°C
<i>in short-circuit:</i>	up to +250°C
Min. bending radius:	acc. to DIN VDE 0298, Part 3
Tensile strenght:	20 N/mm ²
Max speed (main application):	100 m/min
Max. torsion:	± 100°/m

Resistance:



Self-extinguishing and flame retardant acc. to:

DIN VDE 0482 part 265-2-1
EN 50265-2-1
IEC 60332-1-2



Oil resistance acc. to:

DIN VDE 0473 part 811-2-1
IEC EN 60811-2-1

Features:

conveyor belts!

UV, ozone, and moisture resistant
outdoor use
very flexible
acc. to DIN VDE 0250 part 813

GOST-R and WUG approvals on request

for SPEEDS and MINIMUM BENDING RADIUS
see pages from 2 to 8 of catalogue

Applications:

For the conveyor and materials handling equipment

MINING CABLES

FLEXIMINING® MEDIUM F-(N)TSCGEWÖU

Optical fiber



3,6/6 (7,2) kV F-(N)TSCGEWÖU

Part no.	No. of cores x cross section n x mm ²	Outer-Ø ca.mm ± 10%	Copper weight kg/km	Cable weight approx. kg/km	Tensile strength N	AWG no.*)
06080MR1037M63	3x25+2x25/2+6LWL	38,2	960	2635	1125	4
06081MR1037M63	3x25+2x50/2+6LWL	42,1	1200	3070	1125	4
06080MR1037M64	3x35+2x25/2+6LWL	42	1248	3055	1575	2
06081MR1037M64	3x35+2x50/2+6LWL	43,8	1488	3418	1575	2
06080MR1037M65	3x50+2x25/2+6LWL	45,3	1680	3503	2250	1
06081MR1037M65	3x50+2x50/2+6LWL	45,3	1920	3630	2250	1
06080MR1037M66	3x70+2x35/2+6LWL	48,5	2256	4340	3150	2/0
06081MR1037M66	3x70+2x50/2+6LWL	51,7	2496	5270	3150	2/0
06080MR1037M67	3x95+2x50/2+6LWL	54,2	3216	5540	4275	3/0
06080MR1037M68	3x120+2x70/2+6LWL	57,9	4128	7032	5400	4/0
06080MR1037M69	3x150+2x70/2+6LWL	63	4992	8010	6750	250MCM
06080MR1037M70	3x185+2x95/2+6LWL	66	6240	9320	8325	350MCM
06080MR1037M71	3x240+2x120/2+6LWL	74,1	8064	11930	10800	450MCM
06080MR1037M72	3x300+2x150/2+6LWL	79,3	10080	14215	13500	550MCM

6/10 (12) kV F-(N)TSCGEWÖU

Part no.	No. of cores x cross section n x mm ²	Outer-Ø ca.mm ± 10%	Copper weight kg/km	Cable weight approx. kg/km	Tensile strength N	AWG no.*)
06080QR1037M63	3x25+2x25/2+6LWL	42,9	960	2515	1125	4
06081QR1037M63	3x25+2x50/2+6LWL	44,6	1200	2945	1125	4
06080QR1037M64	3x35+2x25/2+6LWL	45,1	1248	2975	1575	2
06081QR1037M64	3x35+2x50/2+6LWL	46,2	1488	3340	1575	2
06080QR1037M65	3x50+2x25/2+6LWL	46,6	1680	3630	2250	1
06081QR1037M65	3x50+2x50/2+6LWL	48,3	1920	3790	2250	1
06080QR1037M66	3x70+2x35/2+6LWL	49,9	2256	4515	3150	2/0
06081QR1037M66	3x70+2x50/2+6LWL	54,7	2496	4740	3150	2/0
06080QR1037M67	3x95+2x50/2+6LWL	55,5	3216	5720	4275	3/0
06080QR1037M68	3x120+2x70/2+6LWL	59,2	4128	6875	5400	4/0
06080QR1037M69	3x150+2x70/2+6LWL	64,3	4992	8215	6750	250MCM
06080QR1037M70	3x185+2x95/2+6LWL	68,3	6240	9518	8325	350MCM
06080QR1037M71	3x240+2x120/2+6LWL	75,4	8064	12185	10800	450MCM
06080QR1037M72	3x300+2x150/2+6LWL	80,6	10080	14522	13500	550MCM

8,7/15 (18) kV F-(N)TSCGEWÖU

Part no.	No. of cores x cross section n x mm ²	Outer-Ø ca.mm ± 10%	Copper weight kg/km	Cable weight approx. kg/km	Tensile strength N	AWG no.*)
06080SR1037M63	3x25+2x25/2+6LWL	45,7	960	3066	1125	4
06081SR1037M63	3x25+2x50/2+6LWL	46,9	1200	3339	1125	4
06080SR1037M64	3x35+2x25/2+6LWL	46,8	1248	3317	1575	2
06081SR1037M64	3x35+2x50/2+6LWL	48,5	1488	3718	1575	2
06080SR1037M65	3x50+2x25/2+6LWL	51,4	1680	4172	2250	1
06081SR1037M65	3x50+2x50/2+6LWL	53,2	1920	4595	2250	1
06080SR1037M66	3x70+2x35/2+6LWL	54,7	2256	5074	3150	2/0
06081SR1037M66	3x70+2x50/2+6LWL	56	2496	5651	3150	2/0
06080SR1037M67	3x95+2x50/2+6LWL	59	3216	6170	4275	3/0
06080SR1037M68	3x120+2x70/2+6LWL	64,1	4128	7515	5400	4/0
06080SR1037M69	3x150+2x70/2+6LWL	67,7	4992	8685	6750	250 MCM
06080SR1037M70	3x185+2x95/2+6LWL	70,7	6240	10022	8325	350 MCM
06080SR1037M71	3x240+2x120/2+6LWL	78,8	8064	12741	10800	450 MCM
06080SR1037M72	3x300+2x150/2+6LWL	84	10080	15068	13500	550 MCM

MINING CABLES

FLEXIMINING® MEDIUM F-(N)TSCGEWÖU

Optical fiber



12/20 (24) kV F-(N)TSCGEWÖU

Part no.	No. of cores x cross section n x mm ²	Outer-Ø ca.mm ± 10%	Copper weight kg/km	Cable weight approx. kg/km	Tensile strength N	AWG no.*)
06080UR1037M63	3x25+2x25/2+6LWL	47	960	3148	1125	4
06081UR1037M63	3x25+2x50/2+6LWL	48,7	1200	3518	1125	4
06080UR1037M64	3x35+2x25/2+6LWL	49,8	1248	3630	1575	2
06081UR1037M64	3x35+2x50/2+6LWL	53	1488	4235	1575	2
06080UR1037M65	3x50+2x25/2+6LWL	54,5	1680	4540	2250	1
06081UR1037M65	3x50+2x50/2+6LWL	54,5	1920	4700	2250	1
06080UR1037M66	3x70+2x35/2+6LWL	57,7	2256	5468	3150	2/0
06081UR1037M66	3x70+2x50/2+6LWL	60	2496	6051	3150	2/0
06080UR1037M67	3x95+2x50/2+6LWL	63,4	3216	6780	4275	3/0
06080UR1037M68	3x120+2x70/2+6LWL	67,1	4128	7946	5400	4/0
06080UR1037M69	3x150+2x70/2+6LWL	70,7	4992	9125	6750	250 MCM
06080UR1037M70	3x185+2x95/2+6LWL	75,2	6240	10756	8325	350 MCM
06080UR1037M71	3x240+2x120/2+6LWL	81,8	8064	13271	10800	450 MCM
06080UR1037M72	3x300+2x150/2+6LWL	88,3	10080	16036	13500	550 MCM

14/25 (30) kV F-(N)TSCGEWÖU

Part no.	No. of cores x cross section n x mm ²	Outer-Ø ca.mm ± 10%	Copper weight kg/km	Cable weight approx. kg/km	Tensile strength N	AWG no.*)
06080WR1037M63	3x25+2x25/2+6LWL	52,3	960	3740	1125	4
06081WR1037M63	3x25+2x50/2+6LWL	52,3	1200	3900	1125	4
06080WR1037M64	3x35+2x25/2+6LWL	55,1	1248	4270	1575	2
06081WR1037M64	3x35+2x50/2+6LWL	55,1	1488	4440	1575	2
06080WR1037M65	3x50+2x25/2+6LWL	58,3	1680	5000	2250	1
06081WR1037M65	3x50+2x50/2+6LWL	58,3	1920	5160	2250	1
06080WR1037M66	3x70+2x35/2+6LWL	63	2256	6190	3150	2/0
06081WR1037M66	3x70+2x50/2+6LWL	63	2496	6390	3150	2/0
06080WR1037M67	3x95+2x50/2+6LWL	67,3	3216	7340	4275	3/0
06080WR1037M68	3x120+2x70/2+6LWL	71	4128	8550	5400	4/0
06080WR1037M69	3x150+2x70/2+6LWL	76	4992	10020	6750	250MCM
06080WR1037M70	3x185+2x95/2+6LWL	79	6240	11410	8325	350MCM
06080WR1037M71	3x240+2x120/2+6LWL	87,5	8064	14380	10800	450MCM
06080WR1037M72	3x300+2x150/2+6LWL	92,7	10080	16820	13500	550MCM

18/30 (36) kV F-(N)TSCGEWÖU

Part no.	No. of cores x cross section n x mm ²	Outer-Ø ca.mm ± 10%	Copper weight kg/km	Cable weight approx. kg/km	Tensile strength N	AWG no.*)
06080XR1037M63	3x25+2x25/2+6LWL	55,7	960	4140	1125	4
06081XR1037M63	3x25+2x50/2+6LWL	55,7	1200	4310	1125	4
06080XR1037M64	3x35+2x25/2+6LWL	58,6	1248	4720	1575	2
06081XR1037M64	3x35+2x50/2+6LWL	58,6	1488	4880	1575	2
06080XR1037M65	3x50+2x25/2+6LWL	63,2	1680	5680	2250	1
06081XR1037M65	3x50+2x50/2+6LWL	63,2	1920	5840	2250	1
06080XR1037M66	3x70+2x35/2+6LWL	66,6	2256	6670	3150	2/0
06081XR1037M66	3x70+2x50/2+6LWL	66,6	2496	6870	3150	2/0
06080XR1037M67	3x95+2x50/2+6LWL	70,7	3216	7860	4275	3/0
06080XR1037M68	3x120+2x70/2+6LWL	75,8	4128	9350	5400	4/0
06080XR1037M69	3x150+2x70/2+6LWL	79,5	4992	10630	6750	250 MCM
06080XR1037M70	3x185+2x95/2+6LWL	82,5	6240	12040	8325	350 MCM
06080XR1037M71	3x240+2x120/2+6LWL	91	8064	15070	10800	450 MCM
06080XR1037M72	3x300+2x150/2+6LWL	97,2	10080	17780	13500	550 MCM

20/35 kV (42) kV

Part no.	No. of cores x cross section n x mm ²	Outer-Ø ca.mm ± 10%	Copper weight kg/km	Cable weight approx. kg/km	Tensile strength N	AWG no.*)
06080YR1037M66	3x70+2x35/2+6LWL	82	2352	9260	3150	2/0

Other dimensions and colors available on request.

MINING CABLES

FLEXIMINING® MEDIUM R2XH1OZR

ELETTROTEK KABEL® FLEXIMINING® MEDIUM R2XH1OZR



Construction:

Conductor:	stranded red copper conductor Cl. 2, acc to IEC 60228, DIN VDE 0295
Inner semi-conductive layer:	semi-conducting rubber compound
Insulation:	XLPE compound
Outer semi-conductive layer:	semi-conducting compound
Earth conductor:	stranded red copper conductor Cl. 2, acc to IEC 60228, DIN VDE 0295
Cores color:	Power: natural color with black semi-conducting compound
Stranding:	phase units laid up with uninsulated earth-conductors in interstices and in contact with screens
Screen:	red copper tapes
Wrapping:	binder tapes + filler compound
Armouring:	double galvanized steel tapes
Outer sheath:	red (similar to RAL 3000), PVC type RZ

Resistance:



Self-extinguishing and flame retardant acc. to:
DIN VDE 0482 part 265-2-1
EN 50265-2-1
IEC 60332-1-2

Technical data:

Nominal voltage:	U ₀ /U 8,7/15 (17,5) kV U ₀ /U 12/20 (24) kV
Test voltage:	U ₀ /U 8,7/15 (17,5) kv = 24 kV U ₀ /U 12/20 (24) kv = 29 kV
Temperature range:	0°C up to + 90°C
Temperature on conductor in service:	up to +90°C

Features:

acc. to IEC 60502-2
possible RG7H1OZR, RG7H1ONR
RoHS approval



8,7/15 kV

Part no.	No. of cores x cross section n x mm ²	Outer-Ø ca.mm ± 10%	Copper weight kg/km	Cable weight approx. kg/km	AWG no.*)
06090SR1037M64	3x35+3x6	49,5	1184	3934	2

12/20 kV

Part no.	No. of cores x cross section n x mm ²	Outer-Ø ca.mm ± 10%	Copper weight kg/km	Cable weight approx. kg/km	AWG no.*)
06090UR1037M64	3x35+3x6	53,9	1198	4433	2
06090UR1037M66	3x70+3x6	63	2630	6840	2/0

Other dimensions and colors available on request.

MINING CABLES

FLEXIMINING® MEDIUM R2XH1O(GS)E

ELETTROTEK KABEL® FLEXIMINING® MEDIUM R2XH1O(GS)E



Construction:

Conductor:	stranded red copper conductor Cl. 2, acc to IEC 60228, DIN VDE 0295
Inner semi-conductive layer:	semi-conducting rubber compound
Insulation:	XLPE compound
Outer semi-conductive layer:	semi-conducting compound
Earth conductor:	stranded red copper conductor Cl. 2, acc to IEC 60228, DIN VDE 0295
Earth semi-conductive layer:	semi-conducting compound
Cores color:	Power: natural color with black semi-conducting compound
Stranding:	phase units laid up with uninsulated earth-conductors in interstices and in contact with screens
Screen:	red copper tapes
Wrapping:	binder tapes + filler compound
Armouring:	GAALTHERM® 600 (GAALSHOCK technology)
Outer sheath:	red (similar to RAL 3000), PE compound

Features:

acc. to IEC 60502-2

RoHS approval



Technical data:

Nominal voltage:	U ₀ /U 8,7/15 (17,5) kV U ₀ /U 12/20 (24) kV
Test voltage:	U ₀ /U 8,7/15 (17,5) kV = 24 kV U ₀ /U 12/20 (24) kV = 29 kV
Temperature range:	0°C up to + 90°C
Temperature on conductor in service:	up to +90°C

8,7/15 kV

Part no.	No. of cores x cross section n x mm ²	Outer-Ø ca.mm ± 10%	Copper weight kg/km	Cable weight approx. kg/km	AWG no.*)
06160SR1037M64	3x35+3x6	49,7	1184	2979	2

12/20 kV

Part no.	No. of cores x cross section n x mm ²	Outer-Ø ca.mm ± 10%	Copper weight kg/km	Cable weight approx. kg/km	AWG no.*)
06160SR1037M66	3x35+3x6	54	1198	3338	2

Other dimensions and colors available on request.

MINING CABLES

FLEXIMINING® MEDIUM (N)3GHSSYCY

ELETTROTEK KABEL® FLEXIMINING® MEDIUM (N)3GHSSYCY



Construction:

Conductor:	Flexible red copper conductor Cl. 5, acc to IEC 60228, DIN VDE 0295
Inner semi-conductive layer:	semi-conducting rubber compound
Insulation:	special rubber EPR compound
Outer semi-conductive layer:	semi-conducting rubber compound
Earth conductor:	red copper wires, laying concentric around each power cores
Control cores Conductor:	Flexible red copper conductor Cl. 5, acc to IEC 60228, DIN VDE 0295
Control cores insulation:	rubber EPR compound
Cores color:	Power: natural color with black semi-conductive compound Control cores: black with white numbers
Stranding:	phase units laid up with control-cores in interstices
Filler:	rubber EPR compound
1st inner sheath:	special PVC compound
Monitoring conductor:	copper wires laying concentric between 1 st and 2 nd inner sheath, (DC resistance 3.30 Ohm/km at 20 °C)
2nd inner sheath:	special PVC compound
Armouring:	galvanized steel wires braid
Outer sheath:	red (similar to RAL 3000), special PVC compound

Technical data:

Nominal voltage:	U ₀ /U 3,6/6 kV U ₀ /U 6/10 kV U ₀ /U 12/20 kV
Max. permissible operating voltage:	7,2 kV 12 kV 24 kV
Temperature range:	
<i>Fixed laying:</i>	-40°C up to +80°C
<i>Flexible application:</i>	+5°C up to +80°C
Max. temperature on conductor:	
<i>In service:</i>	up to +90°C
<i>In shrt circuit:</i>	up to +250°C
Min. bending radius:	5 x D

Resistance:



Self-extinguishing and flame retardant acc. to:
DIN VDE 0482 part 332-1-2
EN 60332-1-2
IEC 60332-1-2

Features:

Ozone and moisture resistant
acc. to standard DIN VDE 0250 part 605
acc. to DIN VDE 0207-20/21
RoHS approval



MINING CABLES

FLEXIMINING® MEDIUM (N)3GHSSYCY

ELETTROTEK KABEL® FLEXIMINING® MEDIUM (N)3GHSSYCY



3,6/6 kV

Part no.	No. of cores x cross section n x mm ²	Outer-Ø ca.mm ± 10%	Cable weight approx. kg/km	AWG no.)*
06160MR1037M63	3x25+3x16/3E+3X2,5ST+UEL	45	3100	4
06160MR1037M64	3x35+3x16/3E+3X2,5ST+UEL	47	3600	2
06160MR1037M65	3x50+3x25/3E+3X2,5ST+UEL	51	4450	1
06160MR1037M66	3x70+3x35/3E+3X2,5ST+UEL	55	5400	2/0
06160MR1037M67	3x95+3x50/3E+3X2,5ST+UEL	60	6550	3/0

6/10 kV

Part no.	No. of cores x cross section n x mm ²	Outer-Ø ca.mm ± 10%	Cable weight approx. kg/km	AWG no.)*
06160QR1037M63	3x25+3x16/3E+3X2,5ST+UEL	55	4450	4
06160QR1037M65	3x50+3x25/3E+3X2,5ST+UEL	59	5400	1
06160QR1037M66	3x70+3x35/3E+3X2,5ST+UEL	62	5900	2/0
06160QR1037M67	3x95+3x50/3E+3X2,5ST+UEL	66	7400	3/0
06160QR1037M68	3x120+3x70/3E+3X2,5ST+UEL	69	8300	4/0

12/20 kV

Part no.	No. of cores x cross section n x mm ²	Outer-Ø ca.mm ± 10%	Cable weight approx. kg/km	AWG no.)*
06160UR1037M64	3x35+3x16/3E+3X2,5ST+UEL	58	5100	2
06160UR1037M65	3x50+3x25/3E+3X2,5ST+UEL	60	5600	1
06160UR1037M66	3x70+3x35/3E+3X2,5ST+UEL	65	6960	2/0
06160UR1037M67	3x95+3x50/3E+3X2,5ST+UEL	68	7700	3/0
06160UR1037M68	3x120+3x70/3E+3X2,5ST+UEL	71	9000	4/0
06160UR1037M69	3x150+3x70/3E+3X2,5ST+UEL	76	9700	250 MCM
06160UR1037M70	3x185+3x95/3E+3X2,5ST+UEL	80	11100	350 MCM

Other dimensions and colors available on request.

FLEXIMINING® SIGNAL 2YSLGCÖU

Acc. to DIN VDE 0250 part 812

CE

ELETTROTEK KABEL® FLEXIMINING® SIGNAL 2YSLGCÖU



Construction:

Conductor:	flexible red copper conductor Cl. 5, acc to IEC 60228, DIN VDE 0295
Insulation:	PE special compound
Cores color:	white with consecutive numbers
Stranding:	cores twisted in pairs, pairs stranded in layers
Inner sheath:	special rubber type EM2 acc. to DIN VDE 0207, part 21
Screen:	tinned copper braid
Outer sheath:	black (similar to RAL9005), rubber PCP type EM2 acc. to DIN VDE 0207, part 21

Resistance:



Self-extinguishing and flame retardant acc. to:
DIN VDE 0482 part 265-2-1
EN 50265-2-1
IEC 60332-1-2



Oil resistance acc. to:
DIN VDE 0473 part 811-2-1
IEC EN 60811-2-1

Technical data:

Nominal voltage:	U ₀ /U 250 V
Test voltage:	1,5 kV
Max. operating voltage:	A.C. U ₀ /U = 350 V D.C. U ₀ /U = 350 V
Temperature range:	
<i>Fixed laying:</i>	-40°C up to +60°C
<i>Flexible application:</i>	-25°C up to +60°C
Temperature at conductor:	
<i>In service:</i>	+60°C
<i>In short circuit:</i>	+150°C
Min. bending radius:	acc. to DIN VDE 0298, Part 3
Tensile strength:	15 N/mm ²
Max. torsion:	+/- 25°/m

Features:

data cables using in conveyor belts

possible bus use
MSHA, GOST-R and WUG approvals on request

for MINIMUM BENDING RADIUS
see pages from 5 to 8 of catalogue

outdoor use, resistant to moisture ozone and UV

RoHS approval



Part no.	No. of cores x cross section n x mm ²	Outer-Ø ca.mm ± 10%	Copper weight kg/km	Cable weight approx. kg/km	AWG no.)*
05090C7C022M10	2x2x1	12	-	245	18
05090C7C052M10	5x2x1	17,3	-	420	18
05090C7C102M10	10x2x1	21,5	-	660	18
05090C7C202M10	20x2x1	26,6	-	1030	18

Other dimensions and colors available on request.

TECHNICAL DATA

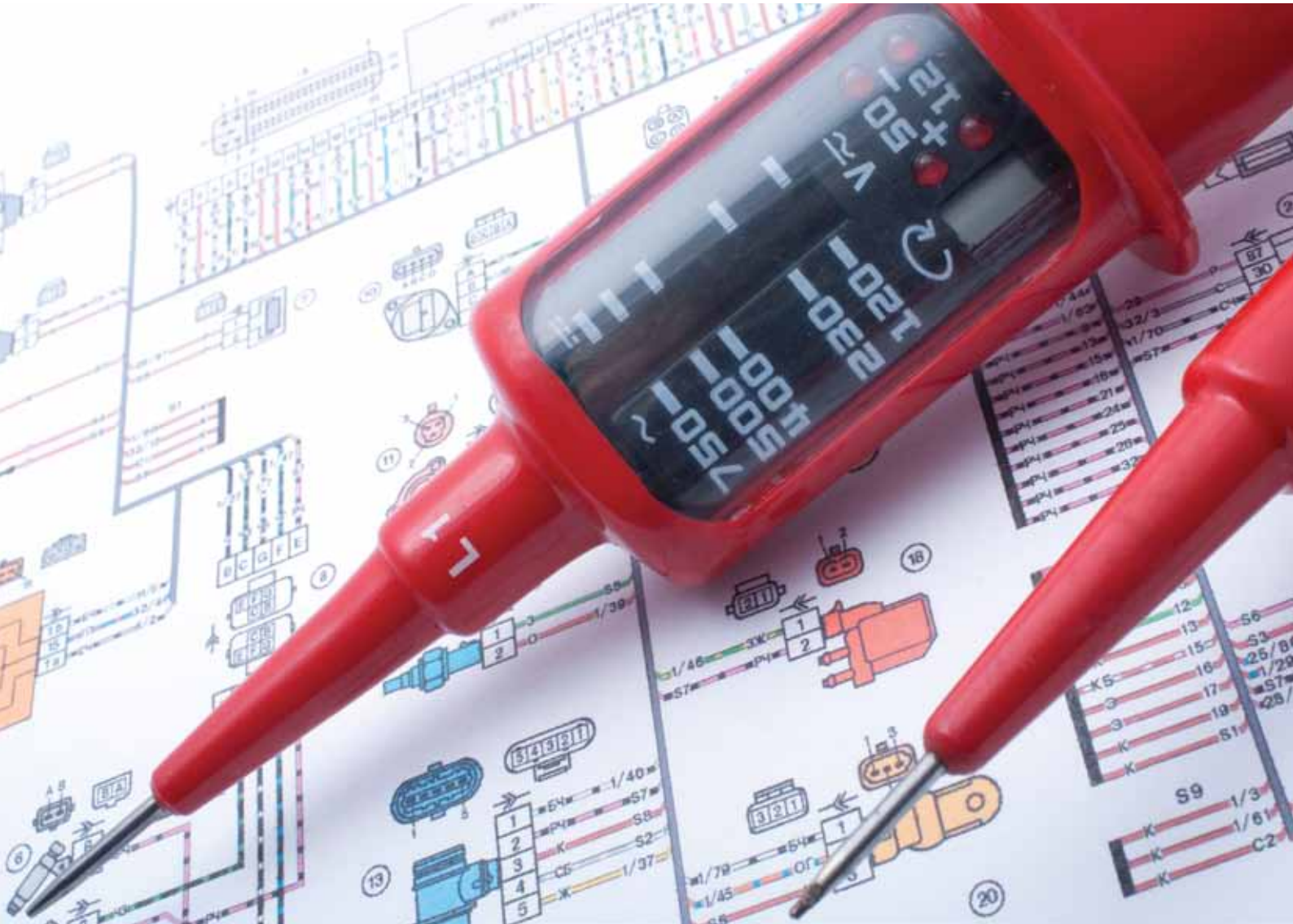

TECHNICAL DATA INDEX

RESISTANCE SYMBOLS LEGEND	459
COSTRUCTION CODE	460/462
STRAND MAKE-UP.....	463/465
CONVERSION FROM AWG.....	466
GENERAL CONVERSION.....	467
COLOUR CODE.....	468/488
LOW VOLTAGE CURRENT CARRYING CAPACITY	489/490
LOW VOLTAGE PHASE SPLITTING - RESISTANCE AND REACTANCE.....	491
LOW VOLTAGE RESISTANCE AND REACTANCE.....	492
LOW VOLTAGE RESISTANCE AND REACTANCE - VOLTAGE DROP	493
LOW VOLTAGE -VOLTAGE DROP.....	494
LOW VOLTAGE - SHORT-CIRCUIT	495/496
MEDIUM VOLTAGE CURRENT CARRYING CAPACITY	497
MEDIUM VOLTAGE CORRECTION FACTORS.....	498
MEDIUM VOLTAGE CORRECTION FACTORS AND PHASE SPLITTING.....	499
MEDIUM VOLTAGE RESISTANCE.....	500
MEDIUM VOLTAGE REACTANCE.....	501
MEDIUM VOLTAGE REACTANCE - SHORT CIRCUIT CURRENT CAPACITY.....	502
MINIMUM BENDING RADIUS.....	503
FLAMABILITY TEST	504/510
HANDLING AND INSTALLATION	511/516
CAPACITY OF KTG POOL DRUMS	517
DRUM SIZE AND DRUM TYPE	518

RESISTANCE SYMBOLS LEGEND



Fire performance
Fire resistant

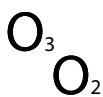

Ozone-Oxygene resistance



mud resistant



Flame retardant and
self-extinguishing

F

flourine resistance



microbe resistant



Halogen-free



weather/atmospheric
resistance



Railway network stability



Smoke density/
low smoke emission



impact-crushing
resistance



Corrosiveness of
combustion gases



Mechanical resistance



Chem. resistance



water and cold
resistance



Abrasion
notch resistant



high temperature/
heat resistance



UV resistant/
Sunlight resistant



electro magnetic
resistance



Ozone resistance



ageing resistance



Oil resistance



water resistant

COSTRUCTION CODE

ITALIAN SYSTEM In accordance with UNEL 3501 I-2000	EUROPEAN SYSTEM In accordance with CEI 20-27/CENELEC HD 361
Conductor flexibility rating	Reference standards
A Aluminium conductor	H In conformity with harmonized standards
F Stranded flexible round conductor	A Suit to IEC standard
FF Stranded very flexible round conductor	N not suit to IEC standard
R Stranded rigid (compacted) conductor	Rated voltage U₀/U
U Solid conductor	03 300/300V
Type and quality of insulation	05 300/500V
E Thermoplastic polyethylene compound	07 450/750V
E4 Cross-linked polyethylene compound at 85°C	1 600/1000V
G Natural and/or synthetic rubber compound at 60°C	Sheath insulating material
G4 Silicone rubber compound at 180°C	B Ethylene propylene rubber at operating temperature of 60°C
G7 High module ethylene propylene rubber compound at 90°C	G Ethylene-vinylacetylene
G8 Ethylene propylene rubber compound at 85°C also for cables without protecting covering	J Glass fibre
G9 Cross-linked elastomeric compound with low emission of smoke and toxic and corrosive gases at 90°C, also for cables without protecting covering	M Mineral
G10 Cross-linked elastomeric compound with low emission of smoke and toxic and corrosive gases at 90°C	N Polychloroprene
G19 Cross-linked elastomeric compound with low emission of smoke and toxic and corrosive gases at 90°C	N2 Special polychloroprene compound for welding machines cables
G20 Cross-linked insulating compound with low emission of smoke and toxic and corrosive gases at 90°C	N4 Chloro-sulphurine or chlorinated polyethylene
M9 Thermoplastic compound with low emission of smoke and toxic and corrosive gases at 70°C	N8 Special water resistant polychloroprene compound
R Polyvinyl chloride compound at 70°C, T11 and T12 type	Q Polyurethane
R2 Polyvinyl chloride compound at 70°C, R2 type	Q4 Polyamide
R4 Polyamide resin compound	R Ethylene propylene rubber and equivalent synthetic elastomer at operating temperature of 60°C
R5 Fluorocarbon resin compound	S Silicone rubber
R5F Fluorocarbon resin compound - tetrafluorine ethylene-esafuorine propylene copolymer (FEP)	T Textile braid (impregnated if necessary) on the cores
R5M Fluorocarbon resin compound - tetrafluorine ethylene-perfluorine methylmethylether copolymer (MFA)	T6 Textile braid (impregnated if necessary) on each cores of multicore cables
R5P R5P Fluorocarbon resin compound - tetrafluorine ethylene-pperfluorine propylmethylether copolymer (PFA)	V Polyvinyl chloride (or PVC)
R7 Polyvinyl chloride compound at 90°C, T13 type	V2 PVC compound at operating temperature of 90°C
T4 Tissue painted with oils and resins	V3 PVC compound for cables installed at low temperatures
V Glass tissue (impregnated if necessary)	V4 Cross-linked PVC
T One or more glass/mica tapes or closed braid of glass	V5 Special oil resistant PVC compound
Screen and concentric conductors	Z Cross-linked polyolefin-based compound with low emission of smoke and toxic and corrosive gases in case of combustion
O Concentric copper conductor	Z1 Thermoplastic compound with low emission of smoke and toxic and corrosive gases in case of combustion
H Metallized paper or carbone-copy or aluminium tape	Metallic covering (concentric conductors and shields)
H1 Copper tape, flat wire or wire screen	C Copper concentric conductor
H2 Copper braid screen	C4 Copper braid screen collectively applied on the cores
H3 Double copper braid screen	A7 Aluminium screen
H4 Longitudinal corrugated steel tape	C5 Copper braid screen individually applied on the cores
H5 Longitudinal laminated aluminium tape	C7 Copper tape, hot wire, or wire screen
Armour (metallic covering)	Armour
A Smooth aluminum sheath or metallic braid shielding	Z2 Steel wire armouring
F Steel wire armouring	Z3 Flat steel wire armouring
H5 Longitudinal laminated aluminium tape armouring	Z4 Steel tape armouring
L Lead alloy sheath	Z5 Steel wire braid
N Steel tape armouring	Shape and special design
P Lead sheath	H "Strippable" flat cables
Z Steel flat wires	H2 "Not strippable" flat cables
Sheath (non metallic covering)	H6 Flat cable with 3 cores or more, in conformity with HD 359 or EN 50214
E Thermoplastic compound, Ez type	H7 Extruded double layer insulated cable
E4 Cross-linked polyethylene compound, E4M type	H8 Extensible cord
G Natural and/or synthetic rubber compound, Gy	Extensible cord
G6 Chloro-sulphurine polyethylene compound, G6M type	D Flexible conductor for arc welding machines cables in conformity with HD 22 Part 6 (different flexibility from HD 383 standard, Class 5)
K Noprene or similar compound, Ky, Kn, Kz type	E Very flexible conductor for arc welding machines cables in conformity with HD 22 Part 6 (different flexibility from HD 383 standard, Class E)
R Polyvinyl chloride compound, Tm1, Tm2 type, Rz type	F Flexible conductor for a flexible cable (in conformity with HD 383 standard, Class 5)
R4 Polyamide resin compound	H Very flexible conductor for a flexible cable (in conformity with HD 383 standard, Class 6)
M1 Thermoplastic compound with low emission of smoke and toxic and corrosive gases	K Flexible conductor for fixed installation (in conformity with HD 383 standard, Class 5)
M2 Elastomeric compound with low emission of smoke and toxic and corrosive gases, M2 type	R Stranded rigid conductor
M3 Elastomeric compound with low emission of smoke and toxic and corrosive gases, M3 type	U Rigid bare conductor
M4 Elastomeric compound with low emission of smoke and toxic and corrosive gases, M4 type	Y Copper-similar conductor
T1 Binding with glass tape	
T Textile braid (impregnated if necessary)	
T2 T2 Special textile braid (impregnated if necessary)	
Cable shape	
O Assembled cores (with covering if necessary), with or without fillers to form a round cable	
D Cores as above, close together in parallel (flattened cable outside)	
X Assembled cores as above, with triplex assembly	
W Cores joined in parallel with an intermediary furrow	
W1 Cores joined in parallel with an intermediary insulating filler	
Self supporting element	
S Metallic rope, embedded in a non-metallic sheath	
Y Textile or metallic rope among the cores or externally tied to the cable	

COSTRUCTION CODE

Power cables acc. to VDE 0250	Harmonized cables acc. to VDE 0281/0282	Telecommunication cables acc. to VDE 0815/0816	Power cables acc. to VDE 0276
1. Reference standards	1. Reference standards	1. Reference standards	1. Reference standards
N according to VDE	H Harmonized type (HAR)	A outdoor cable	N according to VDE
N)/X with reference to VDE	A authorised national standards	G mining cable	(N) with reference to VDE
2. Sheath insulating material	2. Nominal voltage	J installation cable	2. Conductor
Y PVC	01 100 V	L equipment wire	- copper
4Y polyamide	03 300/300 V	S switch cable	A aluminium
5Y PTFE (teflon)	05 300/500 V	Li equipment wire with fine stranded conductor	3. Sheath insulating material
6Y FEP (teflon)	07 450/750 V	RD rhenomatic-cable	Y PVC
9Y polypropylen	11 600/1000 V	RE instrumentation cable	2Y PE
11Y polyurethan (PUR)	3. Sheath insulating material	2. Additional specifications	2X XLPE
2X XLPE	V PVC	B lightning protection	H LSOH compound
G elastomer	V2 PVC (90 °C)	J Induktion protection	4. Concentric conductor
2G silicon	V3 PVC cold-resistant	E Industry-electronics	C Concentric copper conductor
3G EPR-rubber	B EPR-rubber (90 °C)	3. Sheath insulating material	CW Concentric copper conductor reversing lay up
4G EVA	G EVA	Y PVC	5. Screen
5G polychloroprene	E PE	2Y PE	S common copper shield
HX LSOH	R natural or synthetic rubber	02Y cell-PE	SE individually screened cores
3. Cable description	S silicon rubber	02YS foam-Skin	6. Metal sheath
A single-core	X XLPE	5Y PTFE (teflon)	K lead
D solid wire	Z LSOH -compound	6Y FEP (teflon)	7. Inner protection or plastic sheath (see 3.insulation materials)
AF single-core, fine stranded	4. Sheath materials	7Y ETFE (teflon)	8. Armouring
F flexible wire for fittings	V PVC	P paper	F flat steel wire
L fluorescent tube cable	V2 PVC (90 °C)	4. Special construction	R round steel wire
LH connecting cable for light mechanical load	V3 PVC cold-resistant	F petrol jelly filler	G steel tape
MH connecting cable for middle mechanical load	V4 PVC cross-linked	L aluminium sheath	9. Outer sheath (see 3.insulation materials)
SH connecting cable for, heavy mechanical load	V5 PVC oil-resistant	LD corrugated Al.-sheath	10. Protective conductor
SSH connecting cable for special mechanical load	R natural or synthetic rubber	(L) laminated aluminium sheath	-J with green/yellow core
SL control/welding cable	N chloroprene rubber	C copper braided screen	-O without green/yellow core
S control cable	N2 chloroprene rubber for welding cables	(St) screen of plastic coated Al-foil	11. Number of cores
LS light control cable	N4 chloroprene rubber heat- resistant	(K) copper tape screen	12. Conductor form
FL flat cable	N8 chloroprene rubber (water-resistant)	(B) amouring	RE round, solid
Si silicon cable	J glass fibre braid	(Z) steel wire amouring	RM round, stranded
Z twin cable	T textil braid	(Zg) strain-bearing element with glass yarn bundles	SE sector shaped, solid
GL glass fibre	T6 textil over each core	(ZN) strain-bearing element non metallic	SM sector shaped, stranded
Li stranded wires acc. to VDE 0812	Q polyurethan (PUR)	W corrugated steel sheath	
LIF fine stranded wires acc. to VDE 0812	Q4 polyamide	M lead sheath	
4. Special constructions	Z LSOH -compound	Mz special lead sheath	
T strength member	5. Special constructions	b amouring	
ö oil-resistant	C concentric copper conductor	c jute jacket+ bituminous compound	
u flame resistant	C4 copper braided screen	E compound with embedded tape	
w heat-/weather resistant	H flat, divisible cords	5. Sheathing materials (see 3.insulation materials)	
FE fire resistant	H2 flat, non divisible cords	6. Number of elements (number of stranding elements)	
C screen	H6 flat, non divisible cords for elevators	7. Stranding elements	
S steel wire armouring	H7 two-layer insulating jacket	8. Conductor diameter	
5. Sheath materials (see 2. insulation materials)	H8 helical cord	2 pair	
P Polyurethan	6. Conductor form	4 quad	
6. Protective conductor	U round, solid	6. Conductor form	
-J with green/yellow core	R round, stranded	U round, solid	
-O without green/yellow core	K fine stranded, (fixed installation)	R round, stranded	
7. Number of cores	F fine stranded (flexibel cords)	K fine stranded, (fixed installation)	
8. Cross-section of conductor	H fine stranded (highly flexibile)	F fine stranded (flexibel cords)	
	Y tensil conductor	H fine stranded (highly flexibile)	
	D fine stranded for welding cables	Y tensil conductor	
	E fine stranded for welding cables (highly flexibile)	D fine stranded for welding cables	
	7. Number of cores	E fine stranded for welding cables (highly flexibile)	
	8. Protective conductor	7. Number of cores	
	X without green/yellow core	8. Protective conductor	
	G with green/yellow core	9. Type of stranding	
	9. Cross-section of conductor	F star quad (railway)	
		St star quad with phantom circuit (long distance)	
		St I star quad (long distance)	
		St III star quad (subscriber line)	
		TF star quad for carrier frequency	
		PiMF pair in metal foil DIMF triple in metal foil	
		ViMF quad in metal foil	
		10. Stranding layout	
		Lg stranding in layer	
		Bd stranding in unit	

CONSTRUCTION CODE

Fiber-optic cables acc. to VDE 0888	
1. Application	
J	indoor cable
A	outdoor cable
AT	outdoor cable, breakout type
A/J*	universal cable for outdoor and indoor use
ADSS*	metal-free self supporting overhead cable
2. Tube	
V	tight buffer
D	loose-tube, filled
W	hollow-tube, filled
E	loose-tube, flexible
3. Constructions	
ZS	metal strain relief element/strain relief element in cable-core assembly
S	metal stranding element in cable-core assembly
F	filling compound for filling of stranding interstices in the cable-core assembly
OF	special filling compound for filling of stranding interstices
Q	longitudinal cable-core assembly water-tightness via expanding material
4. Cable sheath	
Y	PVC sheath
H	Halogen-free, flame resistant plastic sheath
2Y	PE sheath
4Y	PA sheath
11Y	PUR sheath
(L)2Y	aluminium multi-layer sheath
(SR)2Y	corrugated steel tape reinforcement under PE sheath
(ZN)2Y	non-metallic strain relief element under PE sheath
(ZN)B2Y	non-metallic strain relief element and rodent-protection under PE sheath
(ZN)BH	non-metallic strain relief element and rodent-protection under Halogen free, flame resistant plastic sheath
(ZN)(L)2Y	non-metallic strain relief element under aluminium multi-layer sheath
(ZN)(SR)2Y	non-metallic strain relief element under corrugated steel tape reinforcement with PE sheath
	number of tubes with one fiber for hollow-core cables
	number of loose-tubes for number of fibers per loose-tube for loose-tube cables
5. Type	
E	single-mode fibers
G	graded-index fiber (multi-mode)
Core	\varnothing in μm for graded index multimode fibers or
Field	\varnothing in μm for single-mode fibers
	cladding \varnothing in μm
	coefficient of attenuation in dB/km
5. Wavelength	
B	850 nm
F	1300 nm bei G, 1310nm for E
H	1550 nm
6. Bandwidth	
	MHz * 1 km for G or coefficient of dispersion in ps/(nm* km) for E
LG	concentr.stranded
SZ	SZ-stranding

STRAND MAKE-UP

STRAND MAKE-UP ACCORDING TO DIN VDE 0295 and IEC 60228

Cross section mm ²	Stranded wires	Multi-Stranded wires	Fine wires	Extra-fine wires
	Class 2 DIN VDE 0295		Class 5 DIN VDE 0295	Class 6 DIN VDE 0295
	1	2	3	4
	Number of single wires x wire Ø mm	Number of single wires x wire Ø mm	Number of single wires x wire Ø mm	Number of single wires x wire Ø mm
0,05				
0,08				
0,09				
0,14			± 18x0,1	± 18x0,1
0,25			± 14x0,15	± 32x0,1
0,34		7x0,25	± 19x0,15	± 42x0,1
0,38		7x0,27	± 12x0,2	± 21x0,15
0,5	7x0,30	7x0,30	± 16x0,2	± 28x0,15
0,75	7x0,37	7x0,37	± 24x0,2	± 42x0,15
1,0	7x0,43	7x0,43	± 32x0,2	± 56x0,15
1,5	7x0,52	7x0,52	± 30x0,25	± 84x0,15
2,5	7x0,67	19x0,41	± 50x0,25	± 140x0,15
4	7x0,85	19x0,52	± 56x0,3	± 224x0,15
6	7x1,05	19x0,64	± 84x0,3	± 192x0,2
10	7x1,35	49x0,51	± 80x0,4	± 320x0,2
16	7x1,70	49x0,65	± 128x0,4	± 512x0,2
25	7x2,13	84x0,62	± 200x0,4	± 800x0,2
35	7x2,52	133x0,58	± 280x0,4	± 1120x0,2
50	19x1,83	133x0,69	± 400x0,4	± 705x0,3
70	19x2,17	189x0,69	± 356x0,5	± 990x0,3
95	19x2,52	259x0,69	± 485x0,5	± 1340x0,3
120	37x2,03	336x0,67	± 614x0,5	± 1690x0,3
150	37x2,27	392x0,69	± 765x0,5	± 2123x0,3
185	37x2,52	494x0,69	± 944x0,5	1470x0,4
240	61x2,24	627x0,70	± 1225x0,5	± 1905x0,4
300	61x2,50	790x0,70	± 1530x0,5	± 2385x0,4
400	61x2,89		± 2035x0,5	
500	61x3,23		± 1768x0,6	
630	91x2,97		± 2228x0,6	

Permissible maximal diameter of single wire	
nominal value mm	maximal value mm
0,2	0,21
0,25	0,26
0,3	0,31
0,4	0,41
0,5	0,51
0,6	0,51

STRAND MAKE-UP

COPPER CONDUCTOR AND STRANDING DATA

Approx outer Ø	Pounds per 1000 ft.	Circular Mils	Size AWG/CM	CONCENTRIC STRAND					ROPE LAY Concentric Strand		ROPE LAY Bunch Strand	
				Class AA	Class A	Class B	Class C	Class D	Class G	Class H	Class K 30AWG (.010")	Class M 34AWG (.0063")
.0050	.0757	25.00	36									
.0056	.0954	31.52	35									
.0063	.1203	39.75	34									
.0071	.1517	50.13	33									
.0080	.1913	63.21	32									
.0089	.2413	79.70	30									
.0100	.3042	100.5	30									
.0113	.3836	126.7	29									
.0126	.4837	159.8	28									
.0142	.6100	201.5	27									
.0159	.7692	254.1	26									
.0179	.9699	320.4	25									
.0201	1.223	404.0	24									
.0226	1.542	509.5	23									
.0254	1.945	642.4	22									
.0285	2.452	810.1	21									
.0363	3.154	1,020	20			7	19				10	26
.0456	5.015	1,620	18			7	19				16	41
.0576	7.974	2,580	16			7	19				26	65
.0726	12.68	4,110	14			7	19	37	49		41	104
.0915	20.16	6,530	12			7	19	37	49		65	186
.1160	32.06	10,380	10			7	19	37	49		104	259
.1600	40.42	13,090	9			7	19	37	49	133		
.1460	51.0	16,510	8			7	19	37	49	133	168	420
.1840	80.9	26,240	6			7	19	37	49	133	266	665
.2320	129	41,740	4	3	7	7	19	37	49	133	420	1064
.2600	162	52,620	3	3	7	7	19	37	49	133	532	1323
.2990	205	66,630	2	3	7	7	19	37	49	133	665	1666
.3320	259	83,690	1	3	7	19	37	61	133	259	836	2107
.3730	326	105,600	1/0	7	7	19	37	61	133	259	1064	2646
.4190	411	133,100	2/0	7	7	19	37	61	133	259	1323	3325
.4700	518	167,800	3/0	7	7	19	37	61	133	259	1666	4256
.5280	653	211,600	4/0	7	7	19	37	61	133	259	2107	5320
.5750	772	250,000	250,000	12	19	37	61	91	259	427	2499	6384
.6300	925	300,000	300,000	12	19	37	61	91	259	427	2989	7581
.6810	1080	350,000	350,000	12	19	37	61	91	259	427	3458	8806
.7280	1236	400,000	400,000	19	19	37	61	91	259	427	3990	10,101
.8130	1542	500,000	500,000	19	37	37	61	91	259	427	5054	12,691
.8930	1850	600,000	600,000	37	37	61	91	127	427	703	5985	14,945
.9980	2316	750,000	750,000	37	61	61	91	127	427	703	7581	18,788
1.152	3086	1,000,000	1,000,000	37	61	61	91	127	427	703	10,101	25,193

STRAND MAKE-UP

DIMENSION AND WEIGHTS OF SOLID COPPER WIRE

Size AWG	Approximate Diameter	Circular Mils	Square Inches	Approximate Lbs/Mft
34	0,00063	39,7	0,0000312	0,120
32	0.0080	64.0	0.0000503	0.194
30	0.0100	100	0.0000785	0.303
29	0.0113	128	0.000100	0.387
28	0.0126	159	0.000125	0.481
27	0.0142	202	0.000158	0.610
26	0.0159	253	0.000199	0.765
25	0.0179	320	0.000252	0.970
24	0.0201	404	0.000317	1.22
23	0.0226	511	0.000401	1.55
22	0.0253	640	0.000503	1.94
21	0.0285	812	0.000638	2.46
20	0.0320	1020	0.000804	3.10
18	0.0403	1620	0.00128	4.92
16	0.0508	2580	0.00203	7.81
14	0.0641	4110	0.00323	12.4
12	0.0808	6530	0.00513	19.8
10	0.1019	10,380	0.00815	31.43
9	0.1144	13,090	0.01028	39.62
8	0.1285	16,510	0.01297	49.98
7	0.1443	20,820	0.01635	63.03
6	0.1620	26,240	0.02061	79.44
5	0.1819	33,090	0.02599	100.2
4	0.2043	41,740	0.03278	130.3
3	0.2294	52,620	0.04133	159.3
2	0.2576	66,360	0.05212	200.9

STRANDING-CLASS CONSTRUCTION AND USES

Concentric-lay Conductors	
Class B	Power cables
Class C	Power cables where more flexible stranding from Class B is desired
Class D	Power cables where extra flexible stranding is desired
Rope-lay and Bunch-stranded Conductors	
Class G	All cables for portable use
Class H	All cables where extreme flexibility is required, e.g. take-up reels
Class I	Apparatus cable and motor leads
Class K	Cords and cables 30 AWG copper wires - Stationary service
Class M	Cords and cables 34 AWG copper wires - Constant service

Note: Class G and H shall have concentric-lay stranded members and Class I, K and M shall have bunched stranded members.

CONVERSION FROM AWG

AMERICAN/EUROPEAN TABLE COMPARISON FROM AWG TO mm²

AWG Number	Cross section mm ² (AMERICAN COMPARISON)	Cross section mm ² (EUROPEAN COMPARISON)	Ø mm	Conductor resistance Ω/km
1000 MCM	507	500	29,3	0,036
900	456	-	27,8	0,04
750	380	400	25,4	0,048
600	304	300	22,7	0,061
550	279	-	21,7	0,066
500	253	240	20,7	0,07
450	228	-	19,6	0,08
400	203	-	18,5	0,09
350	177	185	17,3	0,1
300	152	150	16	0,12
250	127	-	14,6	0,14
4/0	107,2	120	11,68	0,18
3/0	85	95	10,4	0,23
2/0	67,4	70	9,27	0,29
0	53,4	-	8,25	0,37
1	42,4	50	7,35	0,47
2	33,6	35	6,54	0,57
3	26,7	-	5,83	0,71
4	21,2	25	5,19	0,91
5	16,8	-	4,62	1,12
6	13,3	16	4,11	1,44
7	10,6	-	3,67	1,78
8	8,34	10	3,26	2,36
9	6,62	-	2,91	2,77
10	5,26	6	2,59	3,64
11	4,15	-	2,3	4,44
12	3,31	4	2,05	5,41
13	2,63	-	1,83	7,02
14	2,08	2,5	1,63	8,79
15	1,65	-	1,45	11,2
16	1,31	1,5	1,29	14,7
17	1,04	-	1,15	17,8
18	0,823	1	1,024	23
19	0,653	0,75	0,912	28,3
20	0,519	0,5	0,812	34,5
21	0,412	0,38	0,723	44
22	0,324	0,34	0,644	54,8
23	0,259	-	0,573	70,1
24	0,205	0,25	0,511	89,2
25	0,163	-	0,455	111
26	0,128	0,14	0,405	146
27	0,102	-	0,361	176
28	0,0804	0,08	0,321	232
29	0,0646	-	0,286	282
30	0,0503	0,05	0,255	350
31	0,04	-	0,227	446
32	0,032	-	0,202	578
33	0,0252	-	0,18	710
34	0,0200	-	0,16	899
35	0,0161	-	0,143	1125
36	0,0123	-	0,127	1426
37	0,01	-	0,113	1800
38	0,00795	-	0,101	2255
39	0,00632	-	0,0897	2860

4/0 is also known as 0000; 1 mil = inch = 0.0254 mm
*Shown in MCM (circular mills) for bigger cross sections

1 CM = 1 Circ. mil = 0.0005067 mm²
1 MCM = 1000 Circ. mils = 0.5067 mm²

1 CM = 1 Circ. mil = 0.0005067 mm²
1 MCM = 1000 Circ. mils = 0.5067 mm²

GENERAL CONVERSION

GENERAL CONVERSION TABLE

LENGHT		
From	to	Formula
Inch (In)	millimeter (mm)	$In \times 25,4 = mm$
millimeter (mm)	Inch (In)	$mm \times 0,03937 = In$
foot (ft)	meter (m)	$ft \times 0,3048 = m$
meter (m)	foot (ft)	$mt \times 3,218 = ft$
mile (mi)	kilometer (km)	$mi \times 1,609 = km$
kilometer (km)	mile (mi)	$km \times 0,662 = mi$

WEIGHTS		
From	to	Formula
pound (lb)	kilogram (kg)	$lb \times 2,205 = kg$
kilogram (kg)	pound (lb)	$kg : 2,205 = lb$

TEMPERATURE		
From	to	Formula
Fahrenheit (F)	Celsius (C)	$(F-32) \times 0,56 = C$
Celsius (C)	Fahrenheit (F)	$C \times 1,8 + 32 = F$

COLOUR CODE

ELETTROTEK KABEL SINGLE WIRES COLOUR IDENTIFICATION

Core.no	Basic color	RAL
01	BLACK / NERO	9005
02	DARK BLUE / BLU SCURO (RAL 5010)	5010
03	BROWN / MARRONE	8003
04	GREY / GRIGIO	7000
05	YELLOW / GIALLO	1021
06	GREEN / VERDE	6018
07	VIOLET/ VIOLA	4005
08	WHITE / BIANCO	9003
09	ORANGE / ARANCIONE	2003
10	RED / ROSSO	3000
11	LIGHT BLUE / BLU CHIARO (RAL 5015)	5015
12	LIGHT BLUE / BLU CHIARO (RAL 5012)	5012
13	PINK / ROSA	3015
14	SKY BLUE/BLU SKY	5024
15	YELLOW-GREEN / GIALLO-VERDE	1021/6018
16	WHITE-DARK BLUE / BIANCO-BLU SCURO	9003/5010
17	DARK BLUE-WHITE / BLU-BIANCO	5010/9003
18	WHITE-GREY / BIANCO-GRIGIO	9003/7000
19	BLACK-GREEN / NERO-VERDE	9005/6018
20	BLACK-DARK BLUE / NERO-BLU SCURO	9005/5010
21	BLACK-WHITE / NERO-BIANCO	9005/9003
22	BLACK-VIOLET / NERO-VIOLA	9005/4005
23	BLACK-RED / NERO-ROSSO	9005/3000
24	WHITE-RED / BIANCO-ROSSO	9003/3000
25	WHITE-BROWN / BIANCO- MARRONE	9003/8003
26	DARK BLUE-RED / BLU SCURO-ROSSO	5010/3000
27	WHITE-VIOLET / BIANCO-VIOLA	9003/4005
28	WHITE-YELLOW / BIANCO-GIALLO	9003/1021
29	WHITE-GREEN / BIANCO-VERDE	9003/6018
30	WHITE-ORANGE / BIANCO-ARANCIONE	9003/2003
31	OFF WHITE GREY	9002
32	REDDISH BROWN	3016
33	BEIGE	1001
34		
35		
36		
37		
38		
39		

HD 308 S2

no. of cores	Cores with green-yellow protective conductor (-J)	Cores without green-yellow protective conductor (-O)
2	-	BLUE-BROWN
3	GREEN/YELLOW-BLUE-BROWN	BROWN-BLACK-GREY
4	GREEN/YELLOW-BROWN-BLACK-GREY	BLUE-BROWN-BLACK-GREY
5	GREEN/YELLOW-BLUE-BROWN-BLACK-GREY	BLUE-BROWN-BLACK-GREY-BLACK
6	GREEN-YELLOW/BLACK + WHITE PRINTED NUMBERS	BLACK + WHITE PRINTED NUMBERS

Core identification with numbers acc. to EN 50334

Marking inscription for identification of cores of electric cables (number printing).
Other core colours are allowed except green and yellow.

COLOUR CODE

DIN 47100

Number	Colour	Number	Colour
1	WHITE	32	YELLOW - blue
2	BROWN	33	GREEN - red
3	GREEN	34	YELLOW - red
4	YELLOW	35	GREEN - black
5	GREY	36	YELLOW - black
6	PINK	37	GREY - blue
7	BLUE	38	PINK - blue
8	RED	39	GREY - red
9	BLACK	40	PINK - red
10	VIOLET	41	GREY - black
11	GREY - pink	42	PINK - black
12	RED - blue	43	BLUE - black
13	WHITE - green	44	RED - black
14	BROWN - green	45	WHITE - brown - black
15	WHITE - yellow	46	YELLOW - green - black
16	YELLOW - brown	47	GREY - pink - black
17	WHITE - grey	48	RED - blue - black
18	GREY - brown	49	WHITE - green - black
19	WHITE - pink	50	BROWN - green - black
20	PINK - brown	51	WHITE - yellow - black
21	WHITE - blue	52	YELLOW - brown - black
22	BROWN - blue	53	WHITE - grey - black
23	WHITE - red	54	GRAY - brown - black
24	BROWN - red	55	WHITE - pink - black
25	WHITE - black	56	PINK - brown - black
26	BROWN - black	57	WHITE - blue - black
27	GREY - green	58	BROWN - blue - black
28	YELLOW - grey	59	WHITE - red - black
29	PINK - green	60	BROWN - red - black
30	YELLOW - pink	61	BLACK - white
31	GREEN - blue		

COLOUR CODE

COLOUR CODE FOR CABLES JB/OB

The combination of color identification up to 101 cores consists of 11 basic colors. For core 12 and more, one or two additional color rings or longitudinal stripes are printed on the basic color. This ring width is approximately 2mm. The insulation of the conductor gives the first basic color.

JB COLOUR CODE

Number	Color	Number
0 GREEN/YELLOW	34 PINK/BLUE	68 ORANGE/WHITE/BLACK
1 WHITE	35 ORANGE/BLUE	69 TRANS/WHITE/BLACK
2 BLACK	36 TRANS/BLUE	70 BEIGE/WHITE/BLACK
3 BLUE	37 BEIGE/BLUE	71 BROWN/WHITE/BLUE
4 BROWN	38 GREY/BROWN	72 GREY/WHITE/BLUE
5 GREY	39 RED/BROWN	73 RED/WHITE/BLUE
6 RED	40 VIOLET/BROWN	74 VIOLET/WHITE/BLUE
7 VIOLET	41 PINK/BROWN	75 PINK/WHITE/BLUE
8 PINK	42 ORANGE/BROWN	76 ORANGE/WHITE/BLUE
9 ORANGE	43 TRANS/BROWN	77 TRANS/WHITE/BLUE
10 TRANSPARENT	44 BEIGE/BROWN	78 BEIGE/WHITE/BLUE
11 BEIGE	45 RED/GREY	79 GREY/WHITE/BROWN
12 BLACK/WHITE	46 VIOLET/GREY	80 RED/WHITE/BROWN
13 BLUE/WHITE	47 PINK/GREY	81 VIOLET/WHITE/BROWN
14 BROWN/WHITE	48 ORANGE/GREY	82 PINK/WHITE/BROWN
15 GREY/WHITE	49 TRANS/GREY	83 ORANGE/WHITE/BROWN
16 RED/WHITE	50 BEIGE/GREY	84 TRANS/WHITE/BROWN
17 VIOLET/GREY	51 ORANGE/RED	85 BEIGE/WHITE/BROWN
18 PINK/WHITE	52 TRANS/RED	86 RED/WHITE/GREY
19 ORANGE/WHITE	53 BEIGE/RED	87 VIOLET/WHITE/GREY
20 TRANS/WHITE	54 PINK/VIOLET	88 PINK/WHITE/GREY
21 BEIGE/WHITE	55 ORANGE/VIOLET	89 ORANGE/WHITE/GREY
22 BLUE/BLACK	56 TRANS/VIOLET	90 TRANS/WHITE/GREY
23 BROWN/BLACK	57 BEIGE/VIOLET	91 BEIGE/WHITE/GREY
24 GREY/BLACK	58 TRANS/PINK	92 BLUE/WHITE/RED
25 RED/BLACK	59 BEIGE/PINK	93 BROWN/WHITE/RED
26 VIOLET/BLACK	60 TRANS/ORANGE	94 VIOLET/WHITE/RED
27 PINK/BLACK	61 BEIGE/ORANGE	95 PINK/WHITE/RED
28 ORANGE/BLACK	62 BLUE/WHITE/BLACK	62 BLUE/WHITE/BLACK
29 TRANS/BLACK	63 BROWN/WHITE/BLACK	97 BROWN/WHITE/VIOLET
30 BEIGE/BLACK	64 GREY/WHITE/BLACK	98 ORANGE/WHITE/VIOLET
31 BROWN/BLUE	65 RED/WHITE/BLACK	99 BROWN/BLACK/BLUE
32 GREY/BLUE	66 VIOLET/WHITE/BLACK	100 GREY/BLACK/BLUE
33 RED/BLUE	67 PINK/WHITE/BLACK	101 RED/BLACK/BLUE

COLOUR CODE

The cores are to be counted continuously through all layers at the same direction, beginning with the inner layer towards the outside layer

OB COLOUR CODE

Number	Color	Number
1 WHITE	35 ORANGE/BLUE	69 TRANS/WHITE/BLACK
2 BLACK	36 TRANS/BLUE	70 BEIGE/WHITE/BLACK
3 BLUE	37 BEIGE/BLUE	71 BROWN/WHITE/BLACK
4 BROWN	38 GREY/BROWN	72 GREY/WHITE/BLUE
5 GREY	39 RED/BROWN	73 RED/WHITE/BLUE
6 RED	40 VIOLET/BROWN	74 VIOLET/WHITE/BLUE
7 VIOLET	41 PINK/BROWN	75 PINK/WHITE/BLUE
8 PINK	42 ORANGE/BROWN	76 ORANGE/WHITE/BLUE
9 ORANGE	43 TRANS/BROWN	77 TRANS/WHITE/BLUE
10 TRANSPARENT	44 BEIGE/BROWN	78 BEIGE/WHITE/BLUE
11 BEIGE	45 RED/GREY	79 GREY/WHITE/BROWN
12 BLCK/WHITE	46 RED/GREY	80 RED/WHITE/BROWN
13 BLUE/WHITE	47 PINK/GREY	81 VIOLET/WHITE/BROWN
14 BROWN/WHITE	48 ORANGE/GREY	82 PINK/WHITE/BROWN
15 GREY/WHITE	49 TRANS/GREY	83 ORANGE/WHITE/BROWN
16 RED/WHITE	50 BEIGE/GREY	84 TRANS/WHITE/BROWN
17 VIOLET/GREY	51 ORANGE/RED	85 BEIGE/WHITE/BROWN
18 PINK/WHITE	52 TRANS/RED	86 RED/WHITE/GREY
19 ORANGE/WHITE	53 BEIGE/RED	87 VIOLET/WHITE/GREY
20 TRANS/WHITE	54 PINK/VIOLET	88 PINK/WHITE/GREY
21 BEIGE/WHITE	55 ORANGE/VIOLET	89 ORANGE/WHITE/GREY
22 BLUE/BLACK	56 TRANS/VIOLET	90 TRANS/WHITE/GREY
23 BROWN/BLACK	57 BEIGE/VIOLET	91 BEIGE/WHITE/GREY
24 GREY/BLACK	58 TRANS/PINK	92 BLUE/WHITE/RED
25 RED/BLACK	59 BEIGE/PINK	93 BROWN/WHITE/RED
26 VIOLET/BLACK	60 TRANS/ORANGE	94 VIOLET/WHITE/RED
27 PINK/BLACK	61 BEIGE/ORANGE	95 PINK/WHITE/RED
28 ORANGE/BLACK	62 BLUE/WHITE/BLACK	96 ORANGE/WHITE/RED
29 TRANS/BLACK	63 BROWN/WHITE/BLACK	97 BROWN/WHITE/VIOLET
30 BEIGE/BLACK	64 GREY/WHITE/BLACK	98 ORANGE/WHITE/VIOLET
31 BROWN/BLUE	65 RED/WHITE/BLACK	99 BROWN/BLACK/BLUE
32 GREY/BLUE	66 VIOLET/WHITE/BLACK	100 GREY/BLACK/BLUE
33 RED/BLUE	67 PINK/WHITE/BLACK	101 RED/BLACK/BLUE
34 PINK/BLUE	68 ORANGE/WHITE/BLACK	

COLOUR CODE

DIN 0815

1. Colour coding for installation cables

J-Y(St)Y ... Lg

For two-pair cable		
pair 1	A-RED	B-BLACK
pair 2	A-WHITE	B-YELLOW

For cables with more than 2 pairs
The colour of the a-core in the first pair of each layer is red ("counting" pair), in all other pairs it is white.
The colour of the b-core is blue, yellow, green, brown, black in repeating order as follows:

colour of b-core	Nr. of pair									
blue	1	6	11	16	21	26	31	36	41	46
yellow	2	7	12	17	22	27	32	37	42	47
green	3	8	13	18	23	28	33	38	43	48
brown	4	9	14	19	24	29	34	39	44	49
black	5	10	15	20	25	30	35	40	45	50

blue	51	56	61	66	71	76	81	86	91	96
yellow	52	57	62	67	72	77	82	87	92	97
green	53	58	63	68	73	78	83	88	93	98
brown	54	59	64	69	74	79	84	89	94	99
black	55	60	65	70	75	80	85	90	95	100

2. Colour coding for installation cables

JE-Y(St)Y... Bd JE-LiYCY mBd JE-H(St)H Bd JE-LIHCH Bd RD-Y(St)Y AJ-Y(St)YDY Bd Si

For two-pair cable		
pair 1	A-BLUE	B-RED
pair 2	A-GREY	B-YELLOW

For cables with more than 2 pairs.
Colour of basic insulation of pairs in one bunch:

Pair	1		2		3		4	
core	a	b	a	b	a	b	a	b
colour	BLUE	RED	GREY	YELLOW	GREEN	BROWN	WHITE	BLACK

For identification of bunches, cores are marked with black rings and bunches are wrapped by a colored tape.



COLOUR CODE

Identification of bunches

Bunch-N°	Colour of rings	rings for bunches of		Tape
		4 cores	a cores resp. 4 pairs	
1	PINK	I	I	-
2		I	II	-
3		II	III	-
4		II	IV	-
5	ORANGE		I	-
6			II	-
7			III	-
8			IV	-
9	VIOLET		I	-
10			II	-
11			III	-
12			IV	-
13	PINK		I	BLUE
14			II	
15			III	
16			IV	
17	ORANGE		I	RED
18			II	
19			III	
20			IV	

3. Colour coding for installation cables

J-YY ... Bd J-H(St)H ... Bd J-2Y(St)Y St III Bd

The five star-quads of each bunch have the following identification:	
1 basic	insulation of all cores red
2 basic	insulation of all cores green
3 basic	insulation of all cores grey
4 basic	insulation of all cores yellow
5 basic	insulation of all cores white

The cores within one star-quad are marked by rings:

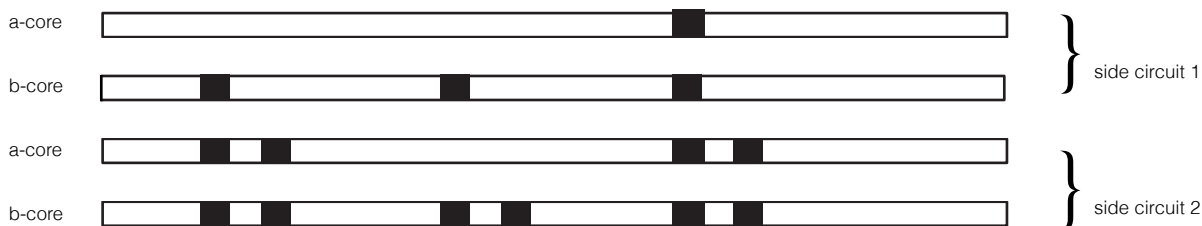

The counting bunch is marked by a red tape in each layer. All other bunches have a white or nature tape.

COLOUR CODE

DIN 0816

4. Core identification for outdoor telephone cables

The five star-quads of each basic unit have the following identification:	
1 quad	basic insulation of all cores red
2 quad	basic insulation of all cores green
3 quad	basic insulation of all cores grey
4 quad	basic insulation of all cores yellow
5 quad	basic insulation of all cores white

The basic insulation of spare quads is red.

The cores within one star-quad are marked by rings:

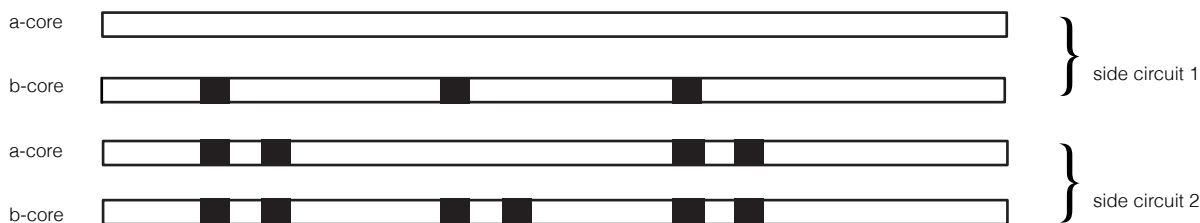

The first basic- or main-unit in each layer is to be marked by an open helix of plastic tape of red (marker). All other basic- or main-units must be wrapped with an open helix of white or uncoloured plastic tape. The quads of a basic-unit are to be counted according to the sequence of basic colours. In cables with more than 5 star-quads, the basic- and main-units must be counted continuously beginning with maker-unit at inner layer towards outside.

Examples for unit stranding

5 star-quads stranded into basic unit

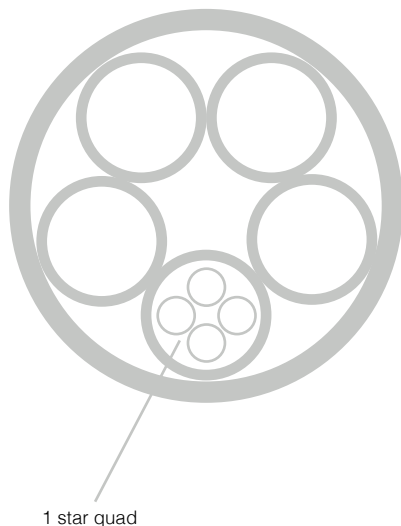

5 basic units each stranded into one main unit = 50 D

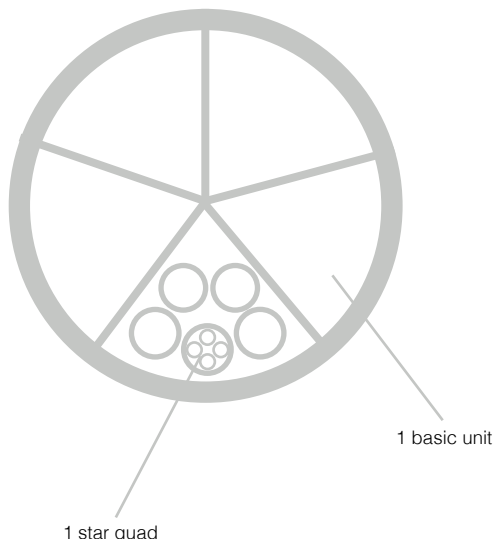

COLOUR CODE

BS 5308 Part I

Multipair colour code		
pair n°	A wire	B wire
1	BLACK	BLUE
2*	BLACK	GREEN
3	BLUE	GREEN
4	BLACK	BROWN
5	BLUE	BROWN
6	GREEN	BROWN
7	BLACK	WHITE
8	BLUE	WHITE
9	GREEN	WHITE
10	BROWN	WHITE
11	BLACK	RED
12	BLUE	RED
13	GREEN	RED
14	BROWN	RED
15	WHITE	RED
16	BLACK	ORANGE
17	BLUE	ORANGE
18	GREEN	ORANGE
19	BROWN	ORANGE
20	WHITE	ORANGE
21	RED	ORANGE
22	BLACK	YELLOW
23	BLUE	YELLOW
24	GREEN	YELLOW
25	BROWN	YELLOW
26	WHITE	YELLOW
27	RED	YELLOW
28	ORANGE	YELLOW
29	BLACK	GREY
30	BLUE	GREY
31	GREEN	GREY
32	BROWN	GREY
33	WHITE	GREY
34	RED	GREY
35	ORANGE	GREY
36	YELLOW	GREY
37	BLACK	VIOLET
38	BLUE	VIOLET
39	GREEN	VIOLET
40	BROWN	VIOLET
41	WHITE	VIOLET
42	RED	VIOLET
43	ORANGE	VIOLET
44	YELLOW	VIOLET
45	GREY	VIOLET
46	BLACK	TURQUOISE
47	BLUE	TURQUOISE
48	GREEN	TURQUOISE
49	BROWN	TURQUOISE
50	WHITE	TURQUOISE

* Single quad (2 pair) Black, Blue, Green and Brown

IDENTIFICATION OF PAIRS: two pair, unscreened or collectively screened cables shall be cabled in quad formation and colour coded in clockwise order or rotation: black,blue,green,brown

PAIR IDENTIFICATION: unscreende pairs shall be identified by means of coloured insulation in the sequence in the table, starting at the centre.

Screened pairs shall be identified either:

- by means of coloured insulation in the sequence in the table, starting at the centre or
- by a numbered polyester film which shall also serve as part of the screen insulation, in which case each pair in the cable shall have one black and one blue core.

COLOUR CODE

BS 5308 Part 2

Multipair colour code		
pair n°	A wire	B wire
1	WHITE	BLUE
2*	WHITE	ORANGE
3	WHITE	GREEN
4	WHITE	BROWN
5	WHITE	GREY
6	RED	BLUE
7	RED	ORANGE
8	RED	GREEN
9	RED	BROWN
10	RED	GREY
11	BLACK	BLUE
12	BLACK	ORANGE
13	BLACK	GREEN
14	BLACK	BROWN
15	BLACK	GREY
16	YELLOW	BLUE
17	YELLOW	ORANGE
18	YELLOW	GREEN
19	YELLOW	BROWN
20	YELLOW	GREY
21	WHITE-Blue	BLUE
22	WHITE-Blue	ORANGE
23	WHITE-Blue	GREEN
24	WHITE-Blue	BROWN
25	WHITE-Blue	GREY
26	RED-Blue	BLUE
27	RED-Blue	ORANGE
28	RED-Blue	GREEN
29	RED-Blue	BROWN
30	RED-Blue	GREY
31	BLUE-Black	BLUE
32	BLUE-Black	ORANGE
33	BLUE-Black	GREEN
34	BLUE-Black	BROWN
35	BLUE-Black	GREY
36	YELLOW-Blue	BLUE
37	YELLOW-Blue	ORANGE
38	YELLOW-Blue	GREEN
39	YELLOW-Blue	BROWN
40	YELLOW-Blue	GREY
41	WHITE-Orange	BLUE
42	WHITE-Orange	ORANGE
43	WHITE-Orange	GREEN
44	WHITE-Orange	BROWN
45	WHITE-Orange	GREY
46	ORANGE-Red	BLUE
47	ORANGE-Red	ORANGE
48	ORANGE-Red	GREEN
49	ORANGE-Red	BROWN
50	ORANGE-Red	GREY

* 2 pair in quad formation: Blue, Green, orange and Brown

IDENTIFICATION OF PAIRS: two pair, unscreened or collectively screened cables shall be cabled in quad formation and colour coded in clockwise order or rotation: black, blue, green, brown

IDENTIFICATION OF CORE: Up to 40 cores: all cores yellow and identified 1 to 40 both printed numbers and written word in black eg 10 core would be coloured yellow and identified by number "10, TEN" in black 41 to 80 cores: all cores black and identified 1 to 40 both printed numbers and written word in yellow eg 50 core would be coloured black and identified by number "10, TEN" in yellow

PAIR IDENTIFICATION: unscrende pairs shall be identified by means of coloured insulation in the sequence in the table, starting at the centre.

Screened pairs shall be identified either:

- by means of coloured insulation in the sequence in the table, starting at the centre or
- by a numbered polyester film which shall also serve as part of the screen insulation, in which case each pair in the cable shall have one black and one blue core.

NOTE: except in the case of bi-colour extrusion the colour indicated by the block letters is known as the base colour, and is

- the extruded colour
- the colour with the greater are of exposure on finished wire.

COLOUR CODE

COLOR CODE US I

Core.no	Basic color	1 st ring	2nd ring
1	BLACK	-	-
2	WHITE	-	-
3	RED	-	-
4	GREEN	-	-
5	BROWN	-	-
6	BLUE	-	-
7	ORANGE	-	-
8	YELLOW	-	-
9	VIOLET	-	-
10	GREY	-	-
11	PINK	-	-
12	BEIGE	-	-

COLOUR CODE

COLOR CODE US2

Comparable with IEEE 1580 table 22 and KI color code (for multi-conductor cables and per ICEA and NEC code)

Core. no	Basic color	1 st stripe	2nd stripe
1	BLACK	-	-
2	WHITE	-	-
3	RED	-	-
4	GREEN	-	-
5	ORANGE	-	-
6	BLUE	-	-
7	WHITE	BLACK	-
8	RED	BLACK	-
9	GREEN	BLACK	-
10	ORANGE	BLACK	-
11	BLUE	BLACK	-
12	BLACK	WHITE	-
13	RED	WHITE	-
14	GREEN	WHITE	-
15	BLUE	WHITE	-
16	BLACK	RED	-
17	WHITE	RED	-
18	ORANGE	RED	-
19	BLUE	RED	-
20	RED	GREEN	-
21	ORANGE	GREEN	-
22	BLACK	WHITE	RED
23	WHITE	BLACK	RED
24	RED	BLACK	WHITE
25	GREEN	BLACK	WHITE
26	ORANGE	BLACK	WHITE
27	BLUE	BLACK	WHITE
28	BLACK	RED	GREEN
29	WHITE	RED	GREEN
30	RED	BLACK	GREEN
31	GREEN	BLACK	ORANGE
32	ORANGE	BLACK	GREEN
33	BLUE	WHITE	ORANGE
34	BLACK	WHITE	ORANGE
35	WHITE	RED	ORANGE
36	ORANGE	WHITE	BLUE
37	WHITE	RED	BLUE
38	BLACK	WHITE	GREEN
39	WHITE	BLACK	GREEN
40	RED	WHITE	GREEN
41	GREEN	WHITE	BLUE
42	ORANGE	RED	GREEN

COLOUR CODE

Core. no	Basic color	1 st stripe	2nd stripe
43	BLUE	RED	GREEN
44	BLACK	WHITE	BLUE
45	WHITE	BLACK	BLUE
46	RED	WHITE	BLUE
47	GREEN	ORANGE	RED
48	ORANGE	RED	BLUE
49	BLUE	RED	ORANGE
50	BLACK	ORANGE	RED
51	WHITE	BLACK	ORANGE
52	RED	ORANGE	BLACK
53	GREEN	RED	BLUE
54	ORANGE	BLACK	BLUE
55	BLUE	BLACK	ORANGE
56	BLACK	ORANGE	GREEN
57	WHITE	ORANGE	GREEN
58	RED	ORANGE	GREEN
59	GREEN	BLACK	BLUE
60	ORANGE	GREEN	BLUE
61	BLUE	GREEN	ORANGE
62	BLACK	RED	BLUE
63	WHITE	ORANGE	BLUE
64	RED	BLACK	BLUE
65	GREEN	ORANGE	BLUE
66	ORANGE	WHITE	RED
67	BLUE	WHITE	RED
68	BLACK	GREEN	BLUE
69	WHITE	GREEN	BLUE
70	RED	GREEN	BLUE
71	GREEN	WHITE	RED
72	ORANGE	RED	BLACK
73	BLUE	RED	BLACK
74	BLACK	ORANGE	BLUE
75	RED	ORANGE	BLUE
76	GREEN	RED	BLACK
77	ORANGE	WHITE	GREEN
78	BLUE	WHITE	GREEN
79	RED	WHITE	ORANGE
80	GREEN	WHITE	ORANGE
81	BLUE	BLACK	GREEN
82	ORANGE	WHITE	-
83	GREEN	RED	-
84	BLACK	GREEN	-
85	WHITE	GREEN	-
86	BLUE	GREEN	-
87	BLACK	ORANGE	-
88	WHITE	ORANGE	-
89	RED	ORANGE	-
90	GREEN	ORANGE	-
91	BLUE	ORANGE	-
92	BLACK	BLUE	-

COLOUR CODE

COLOR CODE US 3

Core. no	Basic color	Color combination
1	BLACK	PAIRED WITH RED
2	BLACK	PAIRED WITH WHITE
3	BLACK	PAIRED WITH GREEN
4	BLACK	PAIRED WITH BLUE
5	BLACK	PAIRED WITH YELLOW
6	BLACK	PAIRED WITH BROWN
7	BLACK	PAIRED WITH ORANGE
8	RED	PAIRED WITH WHITE
9	RED	PAIRED WITH GREEN
10	RED	PAIRED WITH BLUE
11	RED	PAIRED WITH YELLOW
12	RED	PAIRED WITH BROWN
13	RED	PAIRED WITH ORANGE
14	GREEN	PAIRED WITH WHITE
15	GREEN	PAIRED WITH BLUE
16	GREEN	PAIRED WITH YELLOW
17	GREEN	PAIRED WITH BROWN
18	GREEN	PAIRED WITH ORANGE
19	WHITE	PAIRED WITH BLUE
20	WHITE	PAIRED WITH YELLOW
21	WHITE	PAIRED WITH BROWN
22	WHITE	PAIRED WITH ORANGE
23	BLUE	PAIRED WITH YELLOW
24	BLUE	PAIRED WITH BROWN
25	BLUE	PAIRED WITH ORANGE
26	BROWN	PAIRED WITH YELLOW
27	BROWN	PAIRED WITH ORANGE
28	ORANGE	PAIRED WITH YELLOW
29	VIOLET	PAIRED WITH ORANGE
30	VIOLET	PAIRED WITH RED
31	VIOLET	PAIRED WITH WHITE
32	VIOLET	PAIRED WITH GREEN
33	VIOLET	PAIRED WITH BLUE
34	VIOLET	PAIRED WITH YELLOW
35	VIOLET	PAIRED WITH BROWN
36	VIOLET	PAIRED WITH BLACK
37	GREY PAIRED WITH WHITE	

COLOUR CODE

COLOR CODE US 4

Core. no	Basic color	1 st ring	2nd ring
1	BLACK		
2	BROWN		
3	RED		
4	ORANGE		
5	YELLOW		
6	GREEN		
7	BLUE		
8	VIOLET		
9	GREY		
10	WHITE		
11	WHITE	BLACK	
12	WHITE	BROWN	
13	WHITE	RED	
14	WHITE	ORANGE	
15	WHITE	YELLOW	
16	WHITE	GREEN	
17	WHITE	BLUE	
18	WHITE	VIOLET	
19	WHITE	GREY	
20	WHITE	BLACK	BROWN
21	WHITE	BLACK	RED
22	WHITE	BLACK	ORANGE
23	WHITE	BLACK	YELLOW
24	WHITE	BLACK	GREEN
25	WHITE	BLACK	BLUE
26	WHITE	BLACK	VIOLET
27	WHITE	BLACK	GREY
28	WHITE	BLACK	RED
29	WHITE	BROWN	ORANGE
30	WHITE	BROWN	YELLOW
31	WHITE	BROWN	GREEN
32	WHITE	BROWN	BLUE
33	WHITE	BROWN	VIOLET
34	WHITE	BROWN	GREY
35	WHITE	RED	ORANGE
36	WHITE	RED	YELLOW
37	WHITE	RED	GREEN
38	WHITE	RED	BLUE
39	WHITE	RED	VIOLET
40	WHITE	RED	GREY
41	WHITE	ORANGE	YELLOW
42	WHITE	ORANGE	GREEN
43	WHITE	ORANGE	BLUE
44	WHITE	ORANGE	VIOLET
45	WHITE	ORANGE	GREY
46	WHITE	YELLOW	GREEN
47	WHITE	YELLOW	BLUE
48	WHITE	YELLOW	VIOLET
49	WHITE	YELLOW	GREY
50	WHITE	GREEN	BLUE
51	WHITE	GREEN	VIOLET
52	WHITE	GREEN	GREY
53	WHITE	BLUE	VIOLET
54	WHITE	BLUE	GREY
55	WHITE	VIOLET	GREY

COLOUR CODE

COLOR CODE US 5

Core. no	Color combination
1	BLACK PAIRED WITH RED
2	BLACK PAIRED WITH WHITE
3	BLACK PAIRED WITH GREEN
4	BLACK PAIRED WITH BLUE
5	BLACK PAIRED WITH BROWN
6	BLACK PAIRED WITH YELLOW
7	BLACK PAIRED WITH ORANGE
8	RED PAIRED WITH GREEN
9	RED PAIRED WITH WHITE
10	RED PAIRED WITH BLUE
11	RED PAIRED WITH YELLOW
12	RED PAIRED WITH BROWN
13	RED PAIRED WITH ORANGE
14	GREEN PAIRED WITH BLUE
15	GREEN PAIRED WITH WHITE
16	GREEN PAIRED WITH BROWN
17	GREEN PAIRED WITH ORANGE
18	GREEN PAIRED WITH YELLOW
19	WHITE PAIRED WITH BLUE
20	WHITE PAIRED WITH BROWN
21	WHITE PAIRED WITH ORANGE
22	WHITE PAIRED WITH YELLOW
23	BLUE PAIRED WITH BROWN
24	BLUE PAIRED WITH BROWN
25	BLUE PAIRED WITH YELLOW
26	BROWN PAIRED WITH ORANGE
27	BROWN PAIRED WITH YELLOW
28	VIOLET PAIRED WITH RED
29	VIOLET PAIRED WITH WHITE
30	VIOLET PAIRED WITH GREEN
31	VIOLET PAIRED WITH BLUE
32	VIOLET PAIRED WITH BROWN
33	VIOLET PAIRED WITH YELLOW
34	VIOLET PAIRED WITH ORANGE
35	VIOLET PAIRED WITH GREY
36	VIOLET PAIRED WITH BLACK
37	GREY PAIRED WITH RED
38	GREY PAIRED WITH WHITE
39	GREY PAIRED WITH GREEN
40	GREY PAIRED WITH BLUE
41	GREY PAIRED WITH BROWN
42	GREY PAIRED WITH YELLOW
43	GREY PAIRED WITH ORANGE
44	GREY PAIRED WITH BLACK
45	WHITE/BLACK PAIRED WITH RED
46	WHITE/BLACK PAIRED WITH GREEN
47	WHITE/BLACK PAIRED WITH BLUE
48	WHITE/BLACK PAIRED WITH BROWN
49	WHITE/BLACK PAIRED WITH YELLOW
50	WHITE/BLACK PAIRED WITH ORANGE
51	WHITE/BLACK PAIRED WITH VIOLET

COLOUR CODE

K2 Color code (with printed numbers)

Chart 12: ICEA S-66-524 NEMA WC-7

Core.no	Basic color	Stripe
1	BLACK	-
2	RED	-
3	BLUE	-
4	ORANGE	-
5	YELLOW	-
6	BROWN	-
7	RED	BLACK
8	BLUE	BLACK
9	ORANGE	BLACK
10	YELLOW	BLACK
11	BROWN	BLACK
12	BLACK	RED
13	BLUE	RED
14	ORANGE	RED
15	YELLOW	RED
16	BROWN	RED
17	BLACK	BLUE
18	RED	BLUE
19	ORANGE	BLUE
20	YELLOW	BLUE
21	BROWN	BLUE
22	BLACK	ORANGE
23	RED	ORANGE
24	BLUE	ORANGE
25	YELLOW	ORANGE
26	BROWN	ORANGE
27	BLACK	YELLOW
28	RED	YELLOW
29	BLUE	YELLOW
30	ORANGE	YELLOW
31	BROWN	YELLOW
32	BLACK	BROWN
33	RED	BROWN
34	BLUE	BROWN
35	ORANGE	BROWN
36	YELLOW	BROWN

COLOUR CODE

ICEA Table E2 (acc. to ICEA S-73-532)

Core.no	Basic color	Tracer
1	BLACK	-
2	RED	-
3	BLUE	-
4	ORANGE	-
5	YELLOW	-
6	BROWN	-
7	RED	BLACK
8	BLUE	BLACK
9	ORANGE	BLACK
10	YELLOW	BLACK
11	BROWN	BLACK
12	BLACK	RED
13	BLUE	RED
14	ORANGE	RED
15	YELLOW	RED
16	BROWN	RED
17	BLACK	BLUE
18	RED	BLUE
19	ORANGE	BLUE
20	YELLOW	BLUE
21	BROWN	BLUE
22	BLACK	ORANGE
23	RED	ORANGE
24	BLUE	ORANGE
25	YELLOW	ORANGE
26	BROWN	ORANGE
27	BLACK	YELLOW
28	RED	YELLOW
29	BLUE	YELLOW
30	ORANGE	YELLOW
31	BROWN	YELLOW
32	BLACK	BROWN
33	RED	BROWN
34	BLUE	BROWN
35	ORANGE	BROWN
36	YELLOW	BROWN

Pair cables are Black, Red and numbered. Triad cables are Black, Red, Blue and numbered.
Colors repeat after 36 conductors. There are no Green or White conductors stripes.

COLOUR CODE

Standard for Thermocouples Extension and Compensating Cables









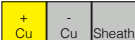
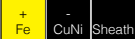
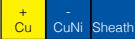

Type/Material	IEC 60584 ⁽¹⁾	ANSI MC 96.1	BS 4937 ed.74 - BS 1843
R + Platinum/13% Rhodium - Platinum	RCA/SCA Copper/Copper-Nickel Cl. 1: Cl. 2: $\pm 30 \mu V (\pm 2,5^{\circ}C)$ 0 ÷ +100°C		
S + Platinum/10% Rhodium - Platinum	RCA/SCB Copper/Copper-Nickel Cl. 1: Cl. 2: $\pm 60 \mu V (\pm 5^{\circ}C)$ 0 ÷ +200°C	SX Copper/Copper-Nickel $\pm 57 \mu V (\pm 5^{\circ}C)$ 0 ÷ +200°C	RX/SX Copper/Copper-Nickel $\pm 3^{\circ}C$ 0 ÷ +200°C
B + Platinum/6% Rhodium - Platinum	BC Copper/Copper $-40 \mu V (-3,5^{\circ}C)$ 0 ÷ +100°C	BX Copper/Copper $-57 \mu V (-3,7^{\circ}C)$ 0 ÷ +100°C	
J + Iron - Copper-Nickel	JX Iron/Copper-Nickel Cl. 1: $\pm 85 \mu V (\pm 1,5^{\circ}C)$ Cl. 2: $\pm 140 \mu V (\pm 2,5^{\circ}C)$ -25 ÷ +200°C	JX Iron/Copper-Nickel Special: $\pm 1,1^{\circ}C$ Standard: $\pm 2,2^{\circ}C$ 0 ÷ +200°C	JX Iron/Copper-Nickel $\pm 3^{\circ}C$ 0 ÷ +200°C
T + Copper - Copper-Nickel	TX Copper/Copper-Nickel Cl. 1: $\pm 30 \mu V (\pm 0,5^{\circ}C)$ Cl. 2: $\pm 60 \mu V (\pm 1,0^{\circ}C)$ -25 ÷ +100°C	TX Copper/Copper-Nickel Special: $\pm 0,5^{\circ}C$ Standard: $\pm 1,0^{\circ}C$ 0 ÷ +100°C	TX Copper/Copper-Nickel $\pm 1^{\circ}C$ 0 ÷ +200°C
E + Nickel-Chromium - Copper-Nickel	EX Nickel-Chromium/Copper-Nickel Cl. 1: $\pm 120 \mu V (\pm 1,5^{\circ}C)$ Cl. 2: $\pm 200 \mu V (\pm 2,5^{\circ}C)$ -25 ÷ +200°C	EX Nickel-Chromium/Copper-Nickel Special: - Standard: $\pm 1,7^{\circ}C$ 0 ÷ +200°C	EX Nickel-Chromium/Copper-Nickel $\pm 1^{\circ}C$ -25 ÷ +100°C
K + Nickel-Chromium - Nickel	KX Nickel-Chromium/Nickel Cl. 1: $\pm 60 \mu V (\pm 1,5^{\circ}C)$ Cl. 2: $\pm 105 \mu V (\pm 2,5^{\circ}C)$ -25 ÷ +200°C	KX Nickel-Chromium/Nickel Special: - Standard: $\pm 2,2^{\circ}C$ 0 ÷ +200°C	KX Nickel-Chromium/Nickel $\pm 3^{\circ}C$ 0 ÷ +200°C
K + Nickel-Chromium - Nickel	KCB Copper/Copper-Nickel Cl. 1: - Cl. 2: $\pm 100 \mu V (\pm 2,5^{\circ}C)$ 0 ÷ +100°C	VX⁽²⁾ Copper/Copper-Nickel Special: - Standard: $\pm 2,2^{\circ}C$ 0 ÷ +100°C	VX Copper/Copper-Nickel $\pm 3^{\circ}C$ 0 ÷ +200°C
K + Nickel-Chromium - Nickel	KCA Iron/Copper-Nickel Cl. 1: - Cl. 2: $\pm 100 \mu V (\pm 2,5^{\circ}C)$ 0 ÷ +150°C	WX⁽²⁾ Iron/Copper-Nickel Special: - Standard: $\pm 3,3^{\circ}C$ 0 ÷ +200°C	
N + Nickel-Chromium-Silica - Nickel-Silica	NX Nickel-Chromium-Silica/Nickel-Silica Cl. 1: $\pm 60 \mu V (\pm 1,5^{\circ}C)$ Cl. 2: $\pm 100 \mu V (\pm 2,5^{\circ}C)$ -25 ÷ +200°C		
	NC Nickel-Chromium/Copper-Nickel Cl. 1: - Cl. 2: $\pm 100 \mu V (\pm 2,5^{\circ}C)$ 0 ÷ +150°C		
U + Copper - Copper-Nickel			
U + Copper - Copper-Nickel			

1) Standard IEC 60584 is equivalent to standard: CEI 65-20, DIN IEC 60584, BS 4937,-30 ed.1993

2) Specified to ISA RP 1.1 ed.1950.



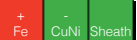

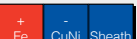











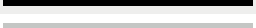

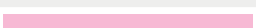
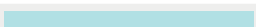



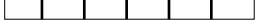

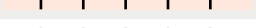





3) Specified to ANSI C 96.1 ed.1969

COLOUR CODE

NF C 42-324	DIN 43710	Electrical Characteristics (approx. values)				
		Size (AWG)	Stranding (N°/mm)	Cond. Resistance (Ω /km at 20°C)		Inductance (mH/km)
				+	-	
SC Copper/Copper-Nickel $\pm 7,0^\circ\text{C}$ $-25\div+200^\circ\text{C}$ 	SoPtRh/SoPt Copper/Copper-Nickel (RX/SX) $\pm 3,0^\circ\text{C}$ $0\div+200^\circ\text{C}$ 	20	1/0,81	35	233	1
		20	7/0,32	35	220	1
		18	1/1,02	22	147	1
		18	10/0,32	23	154	1
		16	1/1,29	14	92	1
		16	16/0,32	15	96	1
BC Copper/Copper $\pm 4,0^\circ\text{C}$ $-25\div+200^\circ\text{C}$ 		20	1/0,81	35	35	1
		20	7/0,32	35	35	1
		18	1/1,02	22	22	1
		18	10/0,32	23	23	1
		16	1/1,29	14	14	1
		16	16/0,32	15	15	1
JX/JC Iron/Copper-Nickel JX: $-25\div+250^\circ\text{C} \pm 1,5^\circ\text{C}$ JC: $-25\div+250^\circ\text{C} \pm 3,0^\circ\text{C}$ 	See LX	20	1/0,81	253	951	6
		20	7/0,32	240	897	6
		18	1/1,02	160	600	6
		18	10/0,32	168	628	6
		16	1/1,29	100	375	6
		16	16/0,32	103	393	6
TX/TC Copper/Copper-Nickel TX: $-25\div+250^\circ\text{C} \pm 0,5^\circ\text{C}$ TC: $-25\div+150^\circ\text{C} \pm 1,0^\circ\text{C}$ 	See UX	20	1/0,81	35	951	1
		20	7/0,32	35	897	1
		18	1/1,02	22	600	1
		18	10/0,32	23	628	1
		16	1/1,29	14	375	1
		16	16/0,32	15	393	1
EX/EC Nickel-Chromium/Copper-Nickel EX: $-25\div+250^\circ\text{C} \pm 1,5^\circ\text{C}$ EC: $-25\div+250^\circ\text{C} \pm 3,0^\circ\text{C}$ $-25\div+100^\circ\text{C}$ 		20	1/0,81	1370	951	4
		20	7/0,32	1292	897	4
		18	1/1,02	865	600	4
		18	10/0,32	905	628	4
		16	1/1,29	540	375	4
		16	16/0,32	565	393	4
KX/KC Nickel-Chromium/Copper-Nickel KX: $-25\div+250^\circ\text{C} \pm 1,5^\circ\text{C}$ KC: $-25\div+200^\circ\text{C} \pm 3,0^\circ\text{C}$ 	NiCr/Ni Nickel-Chromium/Nickel (KX) $\pm 3^\circ\text{C}$ $0\div+200^\circ\text{C}$ 	20	1/0,81	1370	567	4
		20	7/0,32	1292	535	4
		18	1/1,02	865	358	4
		18	10/0,32	905	375	4
		16	1/1,29	540	225	4
		16	16/0,32	565	235	4
VC Copper/Copper-Nickel $\pm 3^\circ\text{C}$ $-25\div+100^\circ\text{C}$ 		20	1/0,81	35	951	1
		20	7/0,32	35	897	1
		18	1/1,02	22	600	1
		18	10/0,32	23	628	1
		16	1/1,29	14	375	1
		16	16/0,32	15	393	1
WC Iron/Copper-Nickel $\pm 3^\circ\text{C}$ $-25\div+200^\circ\text{C}$ 	SoNiCr/SoNi Iron/Copper-Nickel (WX) $\pm 3^\circ\text{C}$ $0\div+200^\circ\text{C}$ 	20	1/0,81	253	1010	6
		20	7/0,32	240	952	6
		18	1/1,02	160	637	6
		18	10/0,32	168	666	6
		16	1/1,29	100	398	6
		16	16/0,32	103	417	6
		20	1/0,81	1940	708	4
		20	7/0,32	1776	648	4
		18	1/1,02	1224	446	4
		18	10/0,32	1243	454	4
		16	1/1,29	765	279	4
		16	16/0,32	777	284	4
	Cu/CuNi Copper/Copper-Nickel (UX) $\pm 3^\circ\text{C}$ $0\div+200^\circ\text{C}$ 	20	1/0,81	35	951	1
		20	7/0,32	35	897	1
		18	1/1,02	22	600	1
		18	10/0,32	23	628	1
		16	1/1,29	14	375	1
		16	16/0,32	15	393	1
	Fe/CuNi Iron/Copper-Nickel (LX) $\pm 3^\circ\text{C}$ $0\div+200^\circ$ 	20	1/0,81	253	951	6
		20	7/0,32	240	897	6
		18	1/1,02	160	600	6
		18	10/0,32	168	628	6
		16	1/1,29	100	375	6
		16	16/0,32	103	393	6

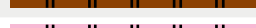
COLOUR CODE

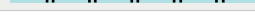
DIN VDE 0888-3, IEC 60304: Color code for fibers in loose tubes of standard optical cables

Fiber. no	Color	
01	RED	
02	GREEN	
03	YELLOW	
04	BLUE	
05	WHITE	
06	VIOLET	
07	ORANGE	
08	BLACK	
09	GREY	
10	BROWN	
11	PINK	
12	TURQUOISE	
13	RED/BLACK	
14	GREEN/BLACK	
15	YELLOW/BLACK	
16	BLUE/BLACK	
17	WHITE/BLACK	
18	VIOLET/BLACK	
19	ORANGE/BLACK	
20	NATURAL/BLACK	
21	GREY/BLACK	
22	BROWN/BLACK	
23	PINK/BLACK	
24	TURQUOISE/BLACK	
25	RED/BLACK/BLACK	
26	GREEN/BLACK/BLACK	
27	YELLOW/BLACK/BLACK	
28	BLUE/BLACK/BLACK	
29	WHITE/BLACK/BLACK	
30	VIOLET/BLACK/BLACK	
31	ORANGE/BLACK/BLACK	
32	NATURAL/BLACK/BLACK	
33	GREY/BLACK/BLACK	
34	BROWN/BLACK/BLACK	
35	PINK/BLACK/BLACK	
36	TURQUOISE/BLACK/BLACK	















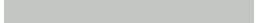





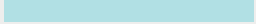

The first color is the basic color of the fiber, the second and third are applied as ring on the fiber

For optical cables with stranded units the following colors are used:

1. Unit	RED (counting unit)	
02	GREEN (direction unit)	
03	all other units have natural color	
04	blinds are black	











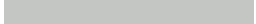

COLOUR CODE

TIA 598: Color code for fibers in loose tubes and tight-buffered optical cables

Fiber. no	Color	
01	BLUE	
02	ORANGE	
03	GREEN	
04	BROWN	
05	GREY	
06	WHITE	
07	RED	
08	BLACK	
09	YELLOW	
10	VIOLET	
11	PINK	
12	TURQUOISE	
13	BLUE/BLACK	
14	ORANGE/BLACK	
15	GREEN/BLACK	
16	BROWN/N/BLACK	
17	GREY/BLACK	
18	WHITE/BLACK	
19	RED/BLACK	
20	BLACK/BLACK	
21	YELLOW/BLACK	
22	VIOLET/BLACK	
23	PINK/BLACK	
24	TURQUOISE/BLACK	

The first color is the basic color of the fiber, the second is applied as ring on the fiber

TIA 598: Color code for loose tubes of standard optical cables

Tubes. no	Color	
01	BLUE	
02	ORANGE	
03	GREEN	
04	BROWN	
05	GREY	
06	WHITE	
07	RED	
08	BLACK	
09	YELLOW	
10	VIOLET	
11	PINK	
12	TURQUOISE	

Identification tubes clockwise direction

LOW VOLTAGE CURRENT CARRYING CAPACITY

Acc. to IEC 60364-5-52 table A.52-10 and B.52.14 (acc. to VDE 0298 T4 08/03)

Current carrying capacities in amperes and Correction factors for ambient air temperature other than 30°C

PVC insulation / Copper conductor 70°C

Conductor temperature +70°C, Ambient temperature: +30°C

Installation methods - table A.52-1					
Nominal cross sectional area of conductor mm ²	Multi core cables	Single core cables			
	Three loaded conductors	Three loaded conductors trefoil	Three loaded conductors flat		
			Touching	Spaced	
				Horizontal	Vertical
1,5	18,5	-	-	-	-
2,5	25	-	-	-	-
4	34	-	-	-	-
6	43	-	-	-	-
10	60	-	-	-	-
16	80	-	-	-	-
25	101	110	114	146	130
35	126	137	143	181	162
50	153	167	174	219	197
70	196	216	225	281	254
95	238	264	275	341	311
120	276	308	321	396	362
150	319	356	372	456	419
185	364	409	427	521	480
240	430	485	507	615	569
300	497	561	587	709	659
400	-	656	689	852	795
500	-	749	789	982	920
600	-	855	905	1138	1070

Correction factors - table B.52.14.																		
Ambient temperature °C	10	15	20	25	30	35	40	45	50	55	60	65	70	75	80	85	90	95
Insulation material PVC	1,22	1,17	1,12	1,06	1	0,94	0,87	0,79	0,71	0,61	0,50	-	-	-	-	-	-	-

NOTE 1:
Circular conductors are assumed for sizes up to and including 16 mm².
Values for larger sizes relate to shaped conductors and may safely be applied to circular conductor

NOTE 2:
De is the external diameter of the cable

LOW VOLTAGE CURRENT CARRYING CAPACITY

Acc.to IEC 60364-5-52 table B.52-12 and B.52.14 (acc. to VDE 0298 T4 08/03)

Current carrying capacities in amperes and Correction factors for ambient air temperature other than 30°C

XLPE or HEPR insulation / Copper conductor

Conductor temperature +90°C, Ambient temperature: +30°C

Installation methods - table B.52-1					
Nominal cross sectional area of conductor mm ²	Multi core cables		Single core cables		
	Three loaded conductors	Three loaded conductors trefoil	Three loaded conductors flat		
			Touching	Spaced	
				Horizontal	Vertical
1,5	23	-	-	-	-
2,5	32	-	-	-	-
4	42	-	-	-	-
6	54	-	-	-	-
10	75	-	-	-	-
16	100	-	-	-	-
25	127	135	141	182	161
35	158	169	176	226	201
50	192	207	216	275	246
70	246	268	279	353	318
95	298	328	342	430	389
120	346	383	400	500	454
150	399	444	464	577	527
185	456	510	533	661	605
240	538	607	634	781	719
300	621	703	736	902	833
400	-	823	868	1085	1008
500	-	946	998	1253	1169
600	-	1088	1151	1454	1362

Correction factors - table B.52.14.																		
Ambient temperature °C	10	15	20	25	30	35	40	45	50	55	60	65	70	75	80	85	90	95
Insulation material XLPE or HEPR	1,15	1,12	1,08	1,04	1	0,96	0,91	0,87	0,82	0,76	0,71	0,65	0,58	0,50	0,41	-	-	-

NOTE 1:
Circular conductors are assumed for sizes up to and including 16 mm².
Values for larger sizes relate to shaped conductors and may safely be applied to circular conductor

NOTE 2:
De is the external diameter of the cable

LOW VOLTAGE PHASE SPLITTING - RESISTANCE AND REACTANCE

PHASE SPLITTING

Single core cables laying in line

Cables laying in trefoil formation

Number 3 core units in the same layer									
2			3			4			
T	T		T	T	T	T	T	T	T
RS	SR		RS	SR	RS	RS	SR	RS	SR

Cables laying in line horizontally or vertically

Number 3 core units in the same layer(*)							
2				4			
RST		TSR		RST		TSR	

(*) For cables installed in layers, the indicated arrangements are repeated for each layer

RESISTANCE AND REACTANCE

Cables insulated with thermoplastic compounds

Apparent resistance of flexible red copper conductor at 70°C and reactance at 50 Hz (for 0,6/1 Kv voltage rates)

Power cables

Conductor cross-section (mm ²)	Resistance at 70 °C		Reactance at 50 Hz	
	c.c. / DC (Ohm/km)	c a. / AC (Ohm/km)	single cores (Ohm/km)	multi cores (Ohm/km)
1,5	15,9	15,9	0,147	0,106
2,5	9,55	9,55	0,186	0,098
4	5,92	5,92	0,129	0,097
6	3,95	3,95	0,121	0,092
10	2,29	2,29	0,111	0,086
16	1,45	1,45	0,103	0,081
25	0,93	0,93	0,097	0,080
35	0,66	0,66	0,093	0,077
50	0,46	0,46	0,090	0,076
70	0,33	0,33	0,086	0,074
95	0,25	0,25	0,085	0,074
120	0,193	0,194	0,081	-
150	0,154	0,156	0,081	-
185	0,127	0,129	0,081	-
240	0,096	0,099	0,080	-

LOW VOLTAGE RESISTANCE AND REACTANCE

Cables insulated with thermoplastic compounds

Control and signalling cables

number of conductors	conductor cross-section (mm ²)	resistance at 70 °C c.c / DC (Ohm/km)	c.c / DC (Ohm/km)	reactance at 50 Hz (Ohm/km)
5	1,5	15,9	15,9	0,106
7	1,5	15,9	15,9	0,106
7	2,5	9,55	9,55	0,098
from 10 to 19	1,5	16	16	0,106
from 10 to 19	2,5	9,65	9,65	0,098
24	1,5	16,1	16,1	0,106
24	2,5	9,7	9,7	0,098

Cables insulated with elastomeric compounds

Resistance at 70°C

Conductor cross-section (mm ²)	Fexible red copper conductor		Rigid red copper conductor	
	c.c. / DC (Ohm/km)	c.a. / AC (Ohm/km)	c.c. / DC (Ohm/km)	c.a. / AC (Ohm/km)
1,5	16,95	16,95	15,4	15,4
2,5	10,17	10,17	9,45	9,45
4	6,31	6,31	5,88	5,88
6	4,20	4,20	3,93	3,93
10	2,43	2,43	2,33	2,33
16	1,54	1,54	1,47	1,47
25	0,99	0,99	0,93	0,93
35	0,71	0,71	0,67	0,67
50	0,49	0,50	0,49	0,49
70	0,34	0,35	0,34	0,34
95	0,26	0,27	0,25	0,25
120	0,20	0,21	0,20	0,20
150	0,16	0,17	0,16	0,16
185	0,13	0,14	0,13	0,13
240	0,102	0,104	0,96	0,99
300	0,081	0,085	0,076	0,080
400	0,062	0,065	0,060	0,064
500	-	-	0,047	0,052
630	-	-	0,037	0,043

LOW VOLTAGE RESISTANCE AND REACTANCE - VOLTAGE DROP

Cables insulated with elastomeric compounds

Reactance at 50 Hz

Conductor cross-section (mm ²)	Rigid red copper conductor		Flexible red copper conductor	
	Single core (Ohm/km)	Multi cores (Ohm/km)	Single core (Ohm/km)	Multi cores (Ohm/km)
1,5	0,146	0,103	0,144	0,100
2,5	0,135	0,095	0,132	0,094
4	0,126	0,090	0,122	0,087
6	0,118	0,085	0,114	0,083
10	0,106	0,079	0,105	0,078
16	0,099	0,076	0,098	0,075
25	0,095	0,076	0,093	0,075
35	0,091	0,074	0,089	0,072
50	0,088	0,073	0,085	0,071
70	0,087	0,072	0,084	0,070
95	0,085	0,070	0,083	0,069
120	0,084	0,070	0,080	0,069
150	0,084	0,070	0,080	0,069
185	0,083	0,070	0,080	0,069
240	0,081	0,070	0,078	0,069
300	0,079	0,069	0,076	0,068
400	0,079	0,069	0,076	0,068
500	0,077	-	0,074	-
630	0,076	-	0,073	-

VOLTAGE DROP

For alternate currents, voltage drop is calculated (Volts) as follows:
$$\phi V = \frac{C_t \cdot I \cdot L}{1000}$$

Where:

C_t (V/A km) = $K \cdot (R \cdot \cos j + X \cdot \sin j)$

L (m) = length of line

I (A) = current

R (ohm/km) = conductor resistance at maximum operating temperature

X (ohm/km) = phase reactance

j = power factor

K = 2 for single-phase system

K = 1,73 for three-phase system

The formula is valid direct currents too

LOW VOLTAGE -VOLTAGE DROP

Voltage drop coefficients (Ct) in AC

Flexible PVC cables at 70 °C

Cross-section	single-phase system single core				three-phase system single core				single-phase system multi-core				three-phase system multi-core			
	cos φ 0,7	cos φ 0,8	cos φ 0,9	cos φ 1	cos φ 0,7	cos φ 0,8	cos φ 0,9	cos φ 1	cos φ 0,7	cos φ 0,8	cos φ 0,9	cos φ 1	cos φ 0,7	cos φ 0,8	cos φ 0,9	cos φ 1
1,5	22,49	25,63	28,77	31,83	19,45	22,17	24,89	27,53	22,43	25,59	28,73	31,83	19,40	22,1	24,86	27,53
2,5	13,56	15,43	17,30	19,10	11,73	13,35	14,97	16,52	13,50	15,39	17,27	19,10	11,68	13,31	14,94	16,52
4	8,47	9,63	10,77	11,84	7,33	8,33	9,32	10,25	8,43	9,59	10,74	11,84	7,29	8,30	9,29	10,25
6	5,70	6,46	7,21	7,90	4,93	5,59	6,24	6,83	5,66	6,43	7,19	7,90	4,89	5,56	6,22	6,83
10	3,36	3,79	4,21	4,57	2,90	3,28	3,64	3,95	3,32	3,76	4,19	4,57	2,87	3,25	3,62	3,95
16	2,17	2,44	2,69	2,90	1,88	2,11	2,33	2,50	2,14	2,41	2,69	2,90	1,85	2,09	2,31	2,50
25	1,45	1,61	1,76	1,87	1,25	1,39	1,53	1,61	1,42	1,59	1,74	1,87	1,23	1,37	1,51	1,61
35	1,06	1,17	1,27	1,33	0,29	1,01	1,10	1,15	1,04	1,15	1,26	1,33	0,90	1	1,09	1,15
50	0,77	0,85	0,91	0,92	0,67	0,73	0,79	0,80	0,76	0,83	0,90	0,92	0,65	0,72	0,78	0,80
70	0,58	0,62	0,66	0,65	0,50	0,54	0,57	0,56	0,56	0,61	0,65	0,65	0,49	0,53	0,56	0,56
95	0,47	0,50	0,52	0,50	0,41	0,43	0,45	0,43	-	-	-	-	0,39	0,42	0,44	0,43
120	0,39	0,41	0,42	0,39	0,34	0,34	0,36	0,34	-	-	-	-	-	-	-	-
150	0,34	0,35	0,35	0,31	0,29	0,30	0,30	0,27	-	-	-	-	-	-	-	-
185	0,30	0,30	0,30	0,26	0,26	0,26	0,26	0,22	-	-	-	-	-	-	-	-
240	0,25	0,25	0,25	0,20	0,22	0,22	0,21	0,17	-	-	-	-	-	-	-	-

Flexible HEPR cables at 90 °C

Cross-section	single-phase system single core				three-phase system single core				single-phase system multi-core				three-phase system multi-core			
	cos φ 0,7	cos φ 0,8	cos φ 0,9	cos φ 1	cos φ 0,7	cos φ 0,8	cos φ 0,9	cos φ 1	cos φ 0,7	cos φ 0,8	cos φ 0,9	cos φ 1	cos φ 0,7	cos φ 0,8	cos φ 0,9	cos φ 1
1,5	23,95	27,31	30,65	33,92	20,71	23,62	26,51	29,34	23,88	27,25	30,61	33,92	20,66	23,57	26,48	29,34
2,5	14,43	16,44	18,43	20,35	12,48	14,22	15,94	17,6	14,38	16,39	18,40	20,35	12,44	14,18	15,91	17,60
4	9,01	10,24	11,47	12,62	7,79	8,86	9,92	10,92	8,96	10,2	11,44	12,62	7,75	8,83	9,89	10,92
6	6,05	6,87	7,67	8,42	5,24	5,94	6,64	7,28	6,01	6,83	7,65	8,42	5,20	5,91	6,61	7,28
10	3,56	4,02	4,48	4,87	3,08	3,48	3,87	4,21	3,52	3,99	4,45	4,87	3,05	3,45	3,85	4,21
16	2,30	2,59	2,86	3,09	1,99	2,24	2,48	2,67	2,27	2,56	2,84	3,09	1,96	2,21	2,46	2,67
25	1,53	1,70	1,87	1,99	1,32	1,47	1,62	1,72	1,5	1,68	1,85	1,99	1,30	1,45	1,60	1,72
35	1,12	1,24	1,35	1,41	0,97	1,07	1,17	1,22	1,09	1,22	1,33	1,41	0,94	1,05	1,15	1,22
50	0,81	0,89	0,96	0,99	0,70	0,77	0,83	0,85	0,79	0,87	0,95	0,99	0,68	0,76	0,82	0,85
70	0,61	0,66	0,70	0,70	0,53	0,57	0,61	0,60	0,59	0,64	0,69	0,70	0,51	0,55	0,59	0,60
95	0,49	0,52	0,55	0,53	0,42	0,45	0,47	0,46	0,47	0,51	0,54	0,53	0,40	0,44	0,46	0,46
120	0,40	0,43	0,44	0,41	0,35	0,37	0,38	0,36	0,39	0,41	0,43	0,41	0,34	0,36	0,37	0,36
150	0,35	0,36	0,37	0,33	0,30	0,31	0,32	0,29	0,33	0,35	0,36	0,33	0,29	0,30	0,31	0,29
185	0,31	0,32	0,32	0,27	0,26	0,27	0,27	0,24	-	-	-	-	0,25	0,26	0,27	0,24
240	0,26	0,26	0,26	0,21	0,22	0,23	0,22	0,18	-	-	-	-	0,21	0,22	0,22	0,18
300	0,23	0,23	0,22	0,17	0,20	0,20	0,19	0,15	-	-	-	-	0,19	0,19	0,18	0,15
400	0,20	0,20	0,19	0,13	0,18	0,17	0,16	0,12	-	-	-	-	0,17	0,16	0,16	0,12
500	0,18	0,17	0,16	0,11	0,16	0,15	0,14	0,091	-	-	-	-	-	-	-	-
630	0,16	0,16	0,14	0,09	0,14	0,14	0,12	0,075	-	-	-	-	-	-	-	-

LOW VOLTAGE - SHORT-CIRCUIT

The protection devices must consider both the maximum and the minimum short-circuit currents reported below

MAXIMUM SHORT-CIRCUIT CURRENT

For alternate currents, voltage drop is calculated (Volts) as follows:
$$S \geq = \frac{I_{cc} \sqrt{T}}{C}$$

Therefore, the max short circuit current accepted by a conductor with section S is calculated with the following formula:
$$I_{cc} (\max) = \frac{S \cdot C}{\sqrt{T}}$$

Where:

T = short circuit duration (sec)

S = cross-section of copper conductor (mm²)

I_{cc} = short circuit current (A)

C = 115 for PVC copper cables (160 °C)

143 for G7 rubber copper cables (250 °C)

NOTE:

The formula above is valid for short time periods (a maximum of 5 sec.).

To calculate the effective short-circuit current allowed by the shield, see the CEI 64-8 standard, appendix D

C coefficient values for copper conductors are dependent on the temperature difference between start and end of short-circuit, acc. to the table 2.02.02 of the CEI 11-17 standard.

Starting temperature Θ _o °C	Ending temperature Θ _o °C					
	140	160	180	200	220	250
90	86	100	112	122	131	143
85	90	104	115	125	134	146
80	94	108	119	129	137	149
75	99	111	122	132	140	151
70	103	115	125	135	143	154
65	107	119	129	138	146	157
60	111	122	132	141	149	160
50	118	129	139	147	155	165
40	126	136	145	153	161	170
30	133	143	152	159	166	176

LOW VOLTAGE - SHORT-CIRCUIT

MINIMUM SHORT-CIRCUIT CURRENT

Minimum short-circuit current is considered during a short-circuit between phase and neutral (or between phase and phase, for a not distributed neutral), in the farthest point of the protected conduit. In case of a system powered by several origins, only one source must be taken into consideration the one corresponding to the minimum value.

The minimum short-circuit current can be calculated using the formulas a) and b), considering: a 50% of resistance increase at 20 °C, due to the conductors heating and a 80% of rated voltage reduction, due to the effect of the short-circuit on the current carrying capacities.

If the impedance of the incoming circuit is well-know, the coefficient 0,8 must be replaced by a specific value.

$$\text{a) } I_{cc} = \frac{0,8 U}{1,5 \rho \frac{2 L}{S}} \quad \text{b) } I_{cc} = \frac{0,8 U_o}{1,5 \rho (1+m) \frac{L}{S}}$$

a) for a neutral not distributed conductor, where:

U = line voltage supplied, linked rated voltage volts

ρ = resistivity of the conductor compounds at 20 °C, ohm • mm² (0,018 for copper - 0,027 for aluminium)

L = length of protected conductor, metres

S = conductor cross-section, mm²

I_{cc} = short-circuit current

b) for a neutral distributed conductor, where:

U_o = phase rating voltage, voltsm











m = ratio of the neutral conductor resistance and the phase conductor resistance

(if they are composed of the same material, the ratio is the result between the phase conductor cross-section and the neutral conductor cross-section)

MEDIUM VOLTAGE CURRENT CARRYING CAPACITY

CURRENT CARRYING CAPACITY

Current carrying capacities in amperes and Correction factors for ambient air temperature other than 30°C

Cross-section mm ²	PVC insulation	Rubber up to 10 kV								
										
	Three loaded conductors	Stretched laying A factor I	Suspended freely in air A 1.05	Reeled in 1 layer A 0.8	2 layers A 0.61	3 layers* A 0.49	4 layers A 0.42	5 layers A 0.38	6 layers A 0.27	7 layers A 0.22
1	18,5	18	19	14	11	9	8	7	5	4
1,5	25	23	24	18	14	11	10	9	6	5
2,5	34	30	2	24	18	15	13	11	8	7
4	43	41	43	33	25	20	17	16	11	9
6	60	53	56	42	32	26	22	20	14	12
10	80	74	78	59	45	36	31	28	20	16
16	101	99	104	79	60	49	42	38	27	22
25	126	131	138	105	80	64	55	50	35	29
35	153	162	170	130	99	79	68	62	44	36
50	196	202	22	162	123	99	85	78	55	44
70	238	250	263	200	153	123	105	95	68	55
95	276	301	316	241	184	147	126	114	81	66
120	319	352	370	282	215	172	148	134	95	77
150	364	404	424	323	246	198	170	154	109	89
185	430	461	484	369	281	226	194	175	124	101
240	497	540	567	432	329	265	227	205	146	119
300	-	620	651	496	378	304	260	236	167	136
Rubber from 15 kV										
16	101	105	-	84	64	51	44	40	28	23
25	126	139	-	111	85	68	58	53	38	31
35	153	172	-	138	105	84	72	65	46	38
50	196	216	-	172	131	105	90	82	58	47
70	238	265	-	212	162	130	111	101	72	58
95	276	319	-	255	195	156	134	121	86	70
120	319	371	-	297	226	182	156	141	100	82
150	364	428	-	342	261	210	180	163	116	94
185	430	488	-	390	298	239	205	185	132	107
240	497	574	-	459	350	281	241	218	155	126
300	-	660	-	528	403	323	277	251	178	145

* The reduction factor is also valid for flat reeling cables (spirally)

Current carrying capacities in A are calculated according to the IEC 60287 standard.

They are calculated assuming the following values:

Ambient temperature for installation in open air : 30 °C

Ambient temperature for underground burial : 20 °

Laying depths: U = 3÷10 kV 0,8 m
 U = 15÷30 kV 1,0 m
 U = 45 kV 1,2 m

Metallic screens interconnected and grounded at both ends

MEDIUM VOLTAGE CORRECTION FACTORS

CORRECTION FACTORS

Insulation	Conductor temperature °C	Cables type	Ambient temperature °C											
			10	15	20	25	30	35	40	45	50	55	60	65
PVC	70	in air cables*	1,22	1,17	1,12	1,06	1	0,94	0,87	0,79	0,71	0,61	0,50	-
EPR / RUBBER	90	in air cables*	1,15	1,12	1,08	1,04	1	0,96	0,91	0,87	0,82	0,76	0,71	0,65
	90	buried cables	1,07	1,04	1	0,96	0,93	0,89	0,85	0,80	0,76	-	-	-

* Not directly exposed to the sun

THREE-CORE CABLES GROUNDED LAYING or single-core cables enclosed in trefoil

Number of cables or trefoil-set (horizontally)		2	3	4	6
Space between cables or trefoil-set	7 cm	0.84	0.74	0.67	0.60
	25 cm	0.86	0.78	0.74	0.69





THREE-CORE CABLES GROUNDED PIPE LAYING

Number of cables (horizontally)	1	2	3
	0.82	0.69	0.61



THREE-CORE CABLES LAYED IN AIR





Number of sets of three (horizontally)	1	2	3	6	9	
Single layer	0,95	0,9	0,88	0,85	0,84	
Layers number (vertical)	1	1	0,98	0,96	0,93	0,92
	2	1	0,95	0,93	0,9	0,89
	3	1	0,94	0,92	0,89	0,88
	6	1	0,93	0,9	0,87	0,86

Number of sets of three (vertical)	1	2	3	6	9
	1	0,93	0,9	0,87	0,86



Cables number (horizontally)	1	2	3	6	9	
Layers number (vertical)	1	0,95	0,84	0,8	0,75	0,73
	2	0,95	0,8	0,76	0,71	0,69
	3	0,95	0,78	0,74	0,7	0,68
	6	0,95	0,76	0,72	0,68	0,66

Cables number (horizontally)	1	2	3	6	9
	0,95	0,78	0,73	0,68	0,66



MEDIUM VOLTAGE CORRECTION FACTORS AND PHASE SPLITTING

SINGLE CORE TREFOIL CORES CABLES LAYED IN AIR

Number of sets of three (horizontally)		1	2	3	6	9
Single layer		0,95	0,9	0,88	0,85	0,84
Layers number (vertical)	1	1	0,98	0,96	0,93	0,92
	2	1	0,95	0,93	0,9	0,89
	3	1	0,94	0,92	0,89	0,88
	4	1	0,93	0,9	0,87	0,86

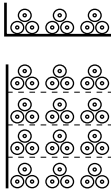

Number of sets of three (vertical)	1	2	3
	0,89	0,86	0,84

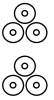

Number of single core (horizontally)		1	2	3
Single layer		0,92	0,89	0,88
Layers number (vertical)	1	1	0,97	0,96
	2	0,97	0,94	0,93
	3	0,96	0,93	0,92
	6	0,94	0,91	0,9

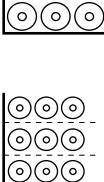

Number of single core (vertical)	1	2	3
	0,94	0,91	0,89



PHASE SPLITTING

Single core cables laying in line

Cables laying in trefoil formation

Number 3 core units in the same layer								
2			3			4		
T	T	T	T	T	T	T	T	T
RS	SR	RS	SR	RS	RS	SR	RS	SR

Cables laying in line horizontally or vertically

Number 3 core units in the same layer(*)			
2		4	
RST	TSR	RST	TSR

(*) For cables installed in layers, the indicated arrangements are repeated for each layer

MEDIUM VOLTAGE RESISTANCE

RESISTANCE

Cables insulated with elastomeric compounds

Apparent resistance of red copper conductor and aluminium at 90°C and at 50 Hz

Conductor cross-section (mm ²)	Single core cables (copper-aluminium conductor)								Single core cables (copper-aluminium conductor any rated voltage)		three core cables (copper-aluminium conductor any rated voltage)	
	1,8/3 kV - 3,6/6 kV (Ohm/km)		6/10 kV - 8,7/15 kV (Ohm/km)		12/20 kV - 18/30 kV (Ohm/km)		26/45 kV (Ohm/km)		(Ohm/km)		(Ohm/km)	
	Cu	Al	Cu	Al	Cu	Al	Cu	Al	Cu	Al	Cu	Al
10	2,33	3,91	2,33	3,91	-	-	-	-	2,33	3,91	2,33	3,91
16	1,47	2,47	1,47	2,47	-	-	-	-	1,47	2,47	1,47	2,47
25	0,92	1,56	0,929	1,56	0,929	1,56	-	-	0,929	1,56	0,929	1,56
35	0,67	1,12	0,671	1,13	0,671	1,13	-	-	0,67	1,13	0,669	1,12
50	0,495	0,832	0,495	0,832	0,495	0,832	-	-	0,495	0,832	0,494	0,83
70	0,347	0,583	0,344	0,58	0,344	0,58	0,344	0,58	0,344	0,58	0,343	0,57
95	0,248	0,416	0,248	0,416	0,248	0,416	0,248	0,416	0,248	0,416	0,247	0,415
120	0,198	0,333	0,198	0,333	0,198	0,333	0,198	0,333	0,198	0,333	0,196	0,329
150	0,161	0,27	0,161	0,27	0,161	0,27	0,161	0,27	0,161	0,27	0,160	0,269
185	0,130	0,218	0,130	0,218	0,130	0,218	0,130	0,218	0,130	0,218	0,129	0,217
240	0,0984	0,165	0,0983	0,165	0,0982	0,165	0,0981	0,165	0,1	0,168	0,1	0,168
300	0,0789	0,132	0,0788	0,132	0,0787	0,132	0,0786	0,132	0,081	0,136	0,08	0,134
400	0,0625	0,105	0,0624	0,105	0,0623	0,105	0,0622	0,105	0,065	0,109	0,065	0,109
500	0,0496	0,0833	0,0494	0,0830	0,0493	0,0828	0,0491	0,0825	0,053	0,0890	0,0536	0,09
630	0,0396	0,0665	0,0394	0,0662	0,0393	0,0662	0,0391	0,0657	0,044	0,0739	-	-

Insulation resistance per phase (MOhm/km)

Conductor cross-section (mm ²)	Nominal voltage						
	1,8/3 kV	3,6/6 kV	6/10 kV	8,7/15 kV	12/20 kV	18/30 kV	26/45 kV
10	1590	-	-	-	-	-	-
16	1360	1505	1645	1990	-	-	-
25	1140	1315	1445	1760	2130	-	-
35	995	1180	1300	1595	1830	2455	-
50	885	1075	1185	1460	1680	2155	-
70	755	945	1045	1300	1505	1950	2105
95	655	835	925	1155	1345	1760	1905
120	595	770	855	1070	1250	1645	1785
150	540	705	785	990	1160	1535	1665
185	485	645	720	910	1070	1420	1550
240	430	580	645	820	965	1295	1415
300	390	530	590	755	890	1200	1310
400	350	470	520	670	790	1070	1165
500	340	450	470	600	720	980	1065
630	330	400	420	540	650	890	970

MEDIUM VOLTAGE REACTANCE

REACTANCE

Single core cables phase reactance at 50 Hz

Conductor cross-section (mm ²)	Single core cables (average values)						
	1,8/3 kV (Ohm/km)	3,6/6 kV (Ohm/km)	6/10 kV (Ohm/km)	8,7/15 kV (Ohm/km)	12/20 kV (Ohm/km)	18/30 kV (Ohm/km)	26/45 kV (Ohm/km)
10	0,19	0,20	0,21	-	-	-	-
16	0,18	0,19	0,20	0,21	-	-	-
25	0,18	0,18	0,19	0,20	0,21	-	-
35	0,17	0,18	0,19	0,19	0,20	0,21	-
50	0,16	0,17	0,18	0,19	0,19	0,20	-
70	0,16	0,17	0,17	0,18	0,19	0,20	0,21
95	0,16	0,16	0,17	0,17	0,18	0,19	0,20
120	0,15	0,16	0,16	0,17	0,18	0,18	0,19
150	0,15	0,16	0,16	0,17	0,17	0,18	0,19
185	0,14	0,15	0,16	0,16	0,17	0,18	0,18
240	0,14	0,15	0,16	0,16	0,16	0,17	0,18
300	0,14	0,15	0,15	0,16	0,16	0,17	0,17
400	0,14	0,15	0,15	0,15	0,16	0,16	0,17
500	0,14	0,14	0,15	0,5	0,15	0,16	0,17
630	0,14	0,14	0,15	0,15	0,15	0,16	0,16

NOTE:
Valid both for copper and aluminium cables

Single core cables laying in trefoil formation phase reactance at 50 Hz

Conductor cross-section (mm ²)	Single core cables						
	1,8/3 kV (Ohm/km)	3,6/6 kV (Ohm/km)	6/10 kV (Ohm/km)	8,7/15 kV (Ohm/km)	12/20 kV (Ohm/km)	18/30 kV (Ohm/km)	26/45 kV (Ohm/km)
10	0,14	0,16	0,16	-	-	-	-
16	0,13	0,14	0,15	0,16	-	-	-
25	0,12	0,13	0,14	0,15	0,15	-	-
35	0,11	0,12	0,13	0,14	0,14	0,16	-
50	0,11	0,12	0,12	0,13	0,13	0,15	-
70	0,1	0,11	0,12	0,12	0,13	0,14	0,15
95	0,098	0,11	0,11	0,12	0,12	0,13	0,14
120	0,097	0,1	0,11	0,11	0,12	0,13	0,14
150	0,092	0,099	0,1	0,11	0,11	0,12	0,13
185	0,089	0,096	0,1	0,11	0,11	0,12	0,12
240	0,086	0,093	0,096	0,1	0,1	0,11	0,12
300	0,084	0,092	0,094	0,098	0,1	0,11	0,12
400	0,082	0,090	0,092	0,095	0,099	0,11	0,11
500	0,081	0,088	0,089	0,092	0,095	0,1	0,11
630	0,079	0,086	0,087	0,090	0,093	0,099	0,10

NOTE:
Valid both for copper and aluminium cables

MEDIUM VOLTAGE REACTANCE - SHORT CIRCUIT CURRENT CAPACITY

Three core cables phase reactance at 50 Hz

Conductor cross-section (mm ²)	Three core cables						
	1,8/3 kV (Ohm/km)	3,6/6 kV (Ohm/km)	6/10 kV (Ohm/km)	8,7/15 kV (Ohm/km)	12/20 kV (Ohm/km)	18/30 kV (Ohm/km)	26/45 kV (Ohm/km)
10	0,11	0,13	0,14	-	-	-	-
16	0,1	0,12	0,13	0,14	-	-	-
25	0,096	0,11	0,12	0,13	0,14	-	-
35	0,091	0,1	0,11	0,12	0,13	0,14	-
50	0,086	0,1	0,11	0,11	0,12	0,13	-
70	0,083	0,095	0,1	0,11	0,11	0,13	0,14
95	0,080	0,091	0,096	0,1	0,11	0,12	0,13
120	0,078	0,088	0,093	0,099	0,1	0,12	0,13
150	0,076	0,086	0,091	0,096	0,1	0,11	0,12
185	0,075	0,083	0,088	0,093	0,098	0,11	0,12
240	0,073	0,081	0,085	0,09	0,094	0,1	-
300	0,071	0,081	0,083	0,088	0,092	0,1	-
400	0,07	0,08	0,081	0,086	-	-	-
500	0,07	0,08	0,081	-	-	-	-

NOTE:

Valid both for copper and aluminium cables

MAX CURRENT CARRYING (kA) IN SHORT CIRCUIT

Conditions for duration 1 second and start temperature 90°C

Conductor	Sections-mm														
	10	15	25	35	50	70	95	120	150	185	240	300	400	500	630
Copper	1,4	2,3	3,6	5	7,1	10	14	17	21	26	34	43	57	72	90
Alluminium	0,92	1,5	2,3	3,2	4,6	6,4	8,7	11	14	17	22	28	37	46	58

MINIMUM BENDING RADIUS

Min. Bending Radii acc. to DIN VDE 0298 part. 3

Cables for fixed laying:				
Cable type:	Voltage up to 0,6/1 kV			Voltage above to 0,6/1 kV
	Outer diameter of cable or thickness of flat cables in mm			
	up to 10	above 10 up to 25	above 25	
Fixed laying:	4 x D*	4 x D	4 x D	6 x D
Single bended installation:	1 x D	2 x D	3 x D	4 x D

Flexible cables:					
Cable type:	Voltage up to 0,6/1 kV				Voltage above to 0,6/1 kV
	Outer diameter of cable or thickness of flat cables in mm				
	up to 8	above 8 up to 12	above 12 up to 20	above 20	
Fixed laying:	3 x D	3 x D	4 x D	4 x D	6 x D
Freely movable:	3 x D	4 x D	5 x D	5 x D	10 x D
Cable entry/gland	3 x D	4 x D	5 x D	5 x D	10 x D
Mechanical restraint ¹⁾					
Cable-drum mode	5 x D	5 x D	5 x D	6 x D	12 x D
Festoon mode:	3 x D	4 x D	5 x D	5 x D	10 x D
Drag-chain mode:	4 x D	4 x D	5 x D	5 x D	10 x D
Roller reversing:	7,5 x D	7,5 x D	7,5 x D	7,5 x D	15 x D

NOTES:

D* = Outer diameter of cable or thickness of flat cables

¹⁾ = Suitability for this application must be assured by means of special structural features

Please contact us in the case of cables types suitable for multiple application types

FLAMABILITY TEST

Examination of the vertical flame length, test method I kV - flame with gas/air mixture

Description	VDE 0482 part. 265-2-1, EN 50265-2-1 and IEC 60332-1	VDE 0482 part. 265-2-2, EN 50265-2-2 and IEC 60332-2
Length of specimen	600 mm	600 mm
Burner	Acc. to EN 60695-2-4-1	Acc. to VDE 0482 part. 265-1 and EN 50265-1
Test temperature	1 kW flame	Defined by the stipulated setting of the Flame length
Position of specimen	Vertical	Vertical
Position of flame	45° to vertical specimen	45° to vertical specimen
Duration of flame	See table 1	20 seconds
Conditions	Cable must be self-extinguishing. The damage or carbonization may only reach max. 50 mm under the upper fixing clamp.	Cable must be self-extinguishing. The damage or carbonization may only reach max. 10 mm under the upper fixing clamp.

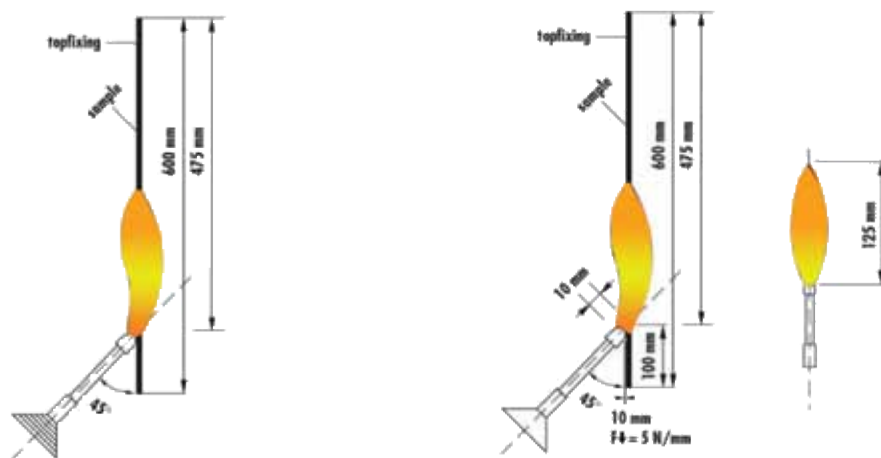

Table I

outer diameter *) of specimen in mm	
Nominal value	Duration of flaming in seconds
$D \leq 25$	60
$25 < D \leq 50$	120
$50 < D \leq 75$	240
$D > 75$	480

*) If cables or insulated cables are tested that are not round (e.g. flat twin cables) their dimensions are to be measured and an equivalent diameter must be calculated from this.

FLAMABILITY TEST

Description	UL 1581 section 1080 (VW-I Flame test)
Length of specimen	455 mm
Burner	Bunsen burner with additional air supply (Tirril-Gasburner) Ø 9,5 mm
Test temperature	500 W flame
Position of specimen	Vertical
Position of flame	20° to vertical specimen
Duration of flame	5 x 15 seconds with 15 seconds between each flaming
Conditions	Paper max. 25% carbonized. The specimen may keep on burning for max. 1 minute after any application. Material dropping must not ignite the cotton (B) lying under the specimen.

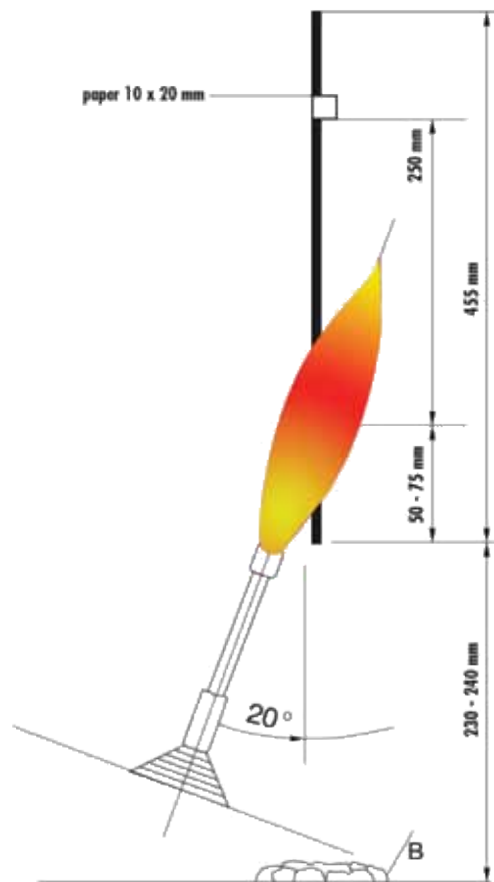

FLAMABILITY TEST

Description	UL 1581 section 1061 (VW-I Flame test)
Length of specimen	455 mm
Burner	Bunsen burner with additional air supply (Tirril-Gasburner) Ø 9,5 mm
Test temperature	500 W flame
Position of specimen	Vertical
Position of flame	20° to vertical specimen
Duration of flame	3 x 60 seconds with 30 seconds between each flaming
Conditions	Paper max. 25% carbonized. The specimen may keep on burning for max. 1 minute after any application. Material dropping must not ignite the cotton (B) lying under the specimen.

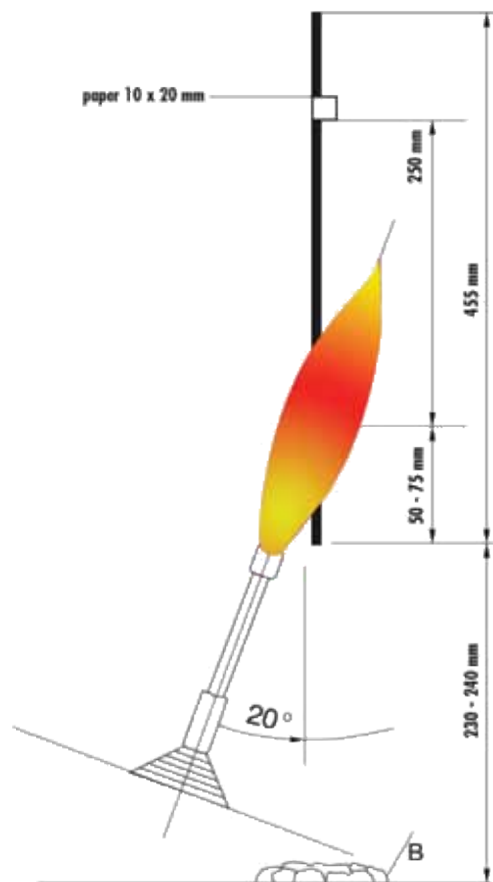

FLAMABILITY TEST

Description	UL 1581 section 1060 (Cable Flame test)
Length of specimen	455 mm
Burner	Bunsen burner with additional air supply (Tirril-Gasburner) Ø 9,5 mm
Test temperature	500 W flame
Position of specimen	Vertical
Position of flame	20° to vertical specimen
Duration of flame	5 x 15 seconds with 15 seconds between each flaming
Conditions	Paper max. 25% carbonized. The specimen may keep on burning for max. 1 minute after any application.

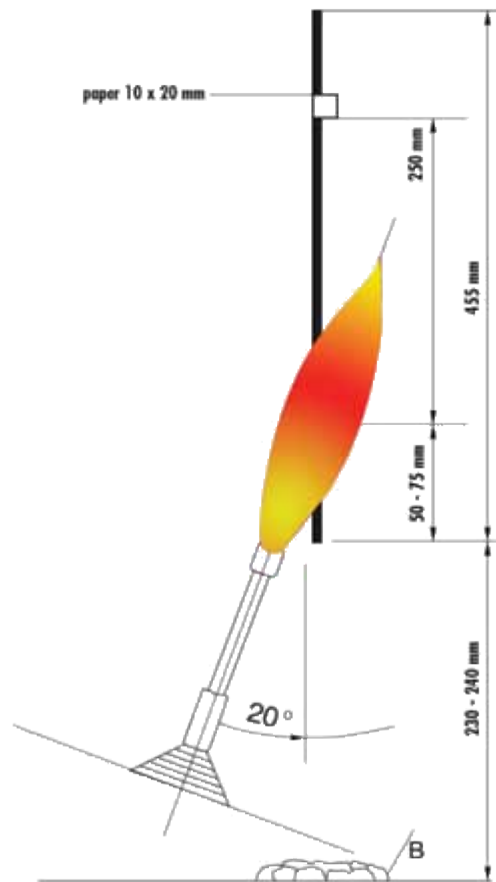

FLAMABILITY TEST

Description	UL 1581 section 1060 (Vertical Flame and FTI Test)
Length of specimen	455 mm
Burner	Bunsen burner with additional air supply (Tirril-Gasburner) Ø 9,5 mm
Test temperature	500 W flame
Position of specimen	Vertical
Position of flame	20° to vertical specimen
Duration of flame	5 x 15 seconds with 15 seconds between each flaming
Conditions	Paper max. 25% carbonized. The specimen may keep on burning for max. 1 minute after any application.

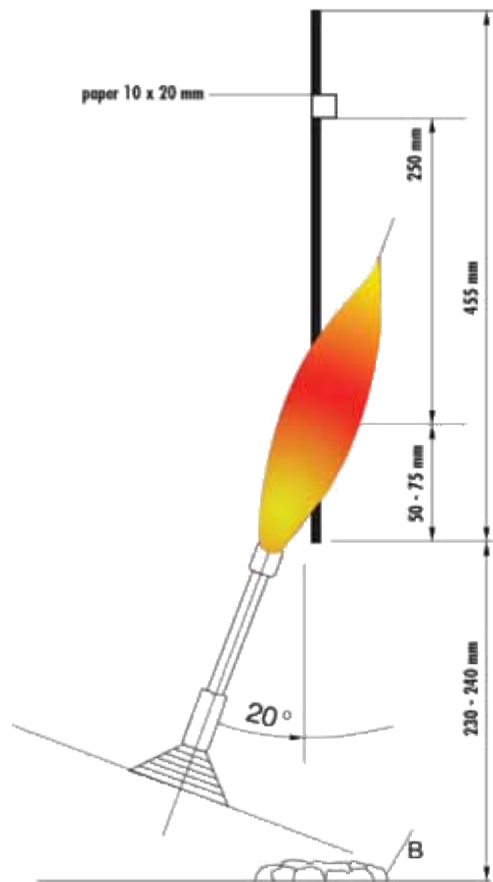

FLAMABILITY TEST

Description	NF C 32-070 "C1"
Length of specimen	455 mm
Burner	500 W flame
Position of specimen	Vertical
Duration of flame	20° to vertical specimen
Conditions	3 x 60 seconds with 30 seconds between each flaming

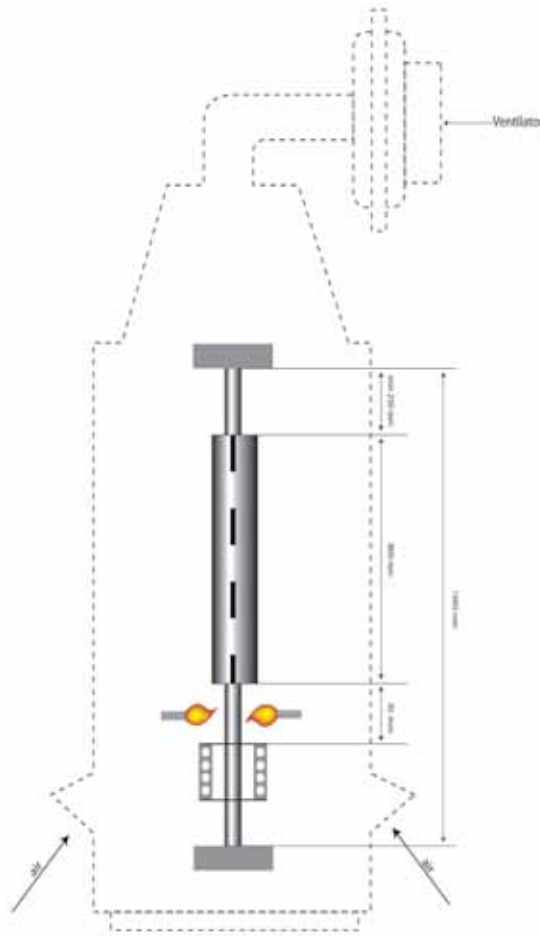

FLAMABILITY TEST

Examination of the vertical flame length of vertical extended bundle of wires and insulated cables

Description	IEC 60332-3, EN 50266, DIN VDE 0482 part. 266
Length of specimen	3500 mm
Burner	Flat burner (Ribbon gas burner of American Gas Furnace Co.)
Test temperature	500 W flame
Position of specimen	Vertical
Position of flame	Horizontal
Duration of flame	Category A, B: 40 minutes Category C, D: 20 minutes
Conditions	The burned portion of the sample must not be longer than 2,5 m measured from the bottom edge of the burner, as far as not otherwise specified in the relevant standards.

	EN 60332-	IEC 60332-
Category A-7 l/m	3/22	3/22
Category B-3,5 l/m	3/23	3/23
Category C-1,5 l/m > 12 mm cable- \varnothing	3/24	3/24
Category D-0,5 l/m \leq 12 mm cable- \varnothing	3/25	3/25
Volume percent of non metallic material per meter		

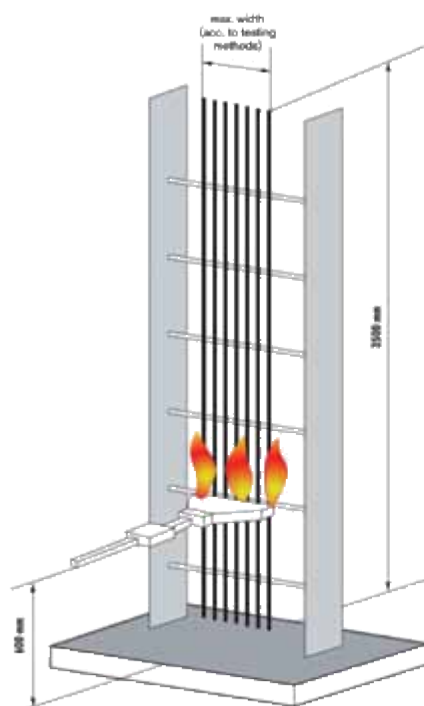

CAPACITY OF KTG POOL DRUMS

WOODEN DRUMS

Drum Type	Flange diameter D1 (mm)	Barrel diameter D2 (mm)	Overall width L1 (mm)	Winding width L2 (mm)	Maximum carrying capacity (kg)	Standard wooden drum weight (kg)
051	500	150	470	410	100	8
061	630	315	415	315	250	17
071	710	355	520	400	250	25
081	800	400	520	400	400	31
091	900	450	690	560	750	47
101	1000	500	710	560	900	71
121	1250	630	890	670	1700	144
141	1400	710	890	670	2000	175
161	1600	800	1100	850	3000	280
181	1800	1000	1100	840	4000	380
201	2000	1250	1350	1045	5000	550
221	2240	1400	1450	1140	6000	710
250	2500	1400	1450	1140	7500	875
251	2500	1600	1450	1130	7500	900
281	2800	1800	1635	1280	10000	1175

PLASTIC DRUMS

Drum Type	Flange diameter D1 (mm)	Barrel diameter D2 (mm)	Overall width L1 (mm)	Winding width L2 (mm)	Maximum carrying capacity (kg)	Standard wooden drum weight (kg)
050	500	150	456	404	100	4
070	710	355	510	400	250	15
080	800	400	510	400	350	16
090	900	450	680	560	400	23
100	1000	500	704	560	500	32

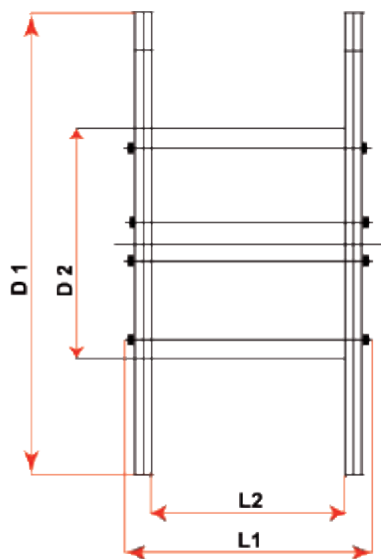

DRUM SIZE AND DRUM TYPE

Cable diameter mm	051	061	071	081	091	101	121	141	161	181	201	221	250	251	281	Cable diameter mm	
6	1130	1110	2024	2755												6	
7	815	840	1480	2340												7	
8	630	640	1064	1463	2730											8	
9	460	470	890	1152	2202	2866										9	
10	390	388	680	980	1768	2349										10	
11	320	315	564	760	1404	1910										11	
12	260	254	470	643	1206	1540										12	
13	220	238	385	542	1032	1339	2727									13	
14	190	190	360	454	880	1159	2265	2967								14	
15	170	180	300	430	749	1000	1990	2480								15	
16	150	140	239	358	632	860	1756	2205								16	
17	130	134	228	294	603	736	1545	1960								17	
18	110	102	218	280	505	705	1355	1737								18	
19	105	96	172	228	485	599	1184	1535	2722							19	
20	100	92	165	220	402	576	1139	1352	2435	2830						20	
21	80	90	159	210	387	485	990	1304	2172	2527						21	
22		65	122	167	315	468	856	1145	1930	2248						22	
23		62	117	160	304	389	827	999	1870	2172	2954					23	
24		60	113	156	294	377	709	967	1657	1927	2608					24	
25		58	110	150	285	365	688	839	1608	1867	2522					25	
26		56	80	116	226	299	668	814	1420	1650	2218					26	
27			78	113	220	290	567	700	1244	1450	2150	2860				27	
28			76	109	215	282	550	680	1210	1410	1880	2777				28	
29			73	106	209	226	462	663	1180	1370	1826	2450			2976	29	
30			70	103	165	220	450	564	1028	1200	1583	2383			2893	30	
31				76	157	214	438	550	1003	1166	1540	2089			2558	31	
32				74	153	209	428	537	866	1009	1500	2035			2490	32	
33				72	150	204	352	450	846	985	1289	1984	2978		2428	33	
34					146	158	344	440	828	962	1257	1726	2908		2134	34	
35					108	154	336	430	710	824	1227	1685	2547		2083	2890	35
36					105	150	329	422	692	806	1040	1646	2270		2035	2820	36
37					103	148	265	348	678	788	1017	1418	2223		1774	2760	37
38						144	259	340	664	772	994	1386	1969		1735	2432	38
39						110	254	334	560	653	972	1356	1930		1697	2380	39
40						105	249	327	549	640	812	1328	1892		1486	2330	40
41						102	244	264	539	627	795	1130	1664		1435	2036	41
42						100	190	259	529	615	779	1107	1633		1406	1995	42
43							187	254	437	510	763	1085	1603		1199	1956	43
44							183	249	430	502	750	1065	1574		1175	1692	44
45							180	245	422	492	610	890	1373		1153	1660	45
46							177	240	415	484	600	874	1349		1130	1630	46
47							174	187	408	475	589	858	1326		1110	1600	47
48							130	184	330	386	578	878	1144		930	1366	48
49							127	180	325	380	568	848	1125		914	1362	49
50							125	178	319	373	558	828	1107		898	1320	50
51							123	175	314	367	542	812	1089		883	1298	51
52							120	172	310	360	535	805	1072		869	1276	52
53								170	305	356	528	805	1072		869	1276	53
54								126	235	280	420	634	898		700	1056	54
55								124	232	276	414	624	885		690	1040	55
56								122	230	270	408	614	872		680	1022	56
57								121	228	267	400	608	860		668	1006	57
58								119	225	263	394	600	848		658	990	58
59								117	222	260	390	594	836		648	974	59
60									220	256	295	466	700		640	803	60
61									216	252	290	460	690		610	790	61
62									160	190	287	453	680		500	780	62
63									158	187	282	448	670		494	770	63
64									156	184	280	440	662		487	760	64
65									154	182	275	435	640		480	748	65
66									152	180	270	430	634		474	738	66
67									150	178	266	426	628		468	728	67
68										174	264	420	620		462	718	68
69										172	262	416	614		456	708	69
70										170	260	412	608		450	700	70
71										168	258	408	602		444	692	71
72										166	256	404	596		438	684	72
73										164	254	400	590		432	676	73
74										162	252	396	584		426	668	74
75										160	250	392	578		420	660	75
76										112	170	291	380		322	526	76
77										110	168	287	375		318	520	77
78										109	166	284	370		314	514	78
79										108	164	281	367		310	508	79
80										107	163	278	363		306	502	80



approx. drum barrel $\varnothing \leq 40 \times D$
 approx. drum barrel $\varnothing \leq 25 \times D$
 approx. drum barrel $\varnothing \leq 15 \times D$
 approx. drum barrel $\varnothing \leq 15 \times D$
 approx. drum barrel $\varnothing \leq 50 \times D$



M.F. 7
2703-141020-00

DISC 1A

A
B
C

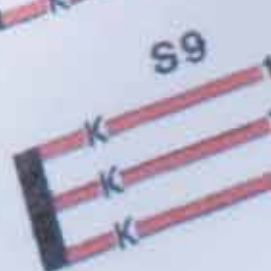
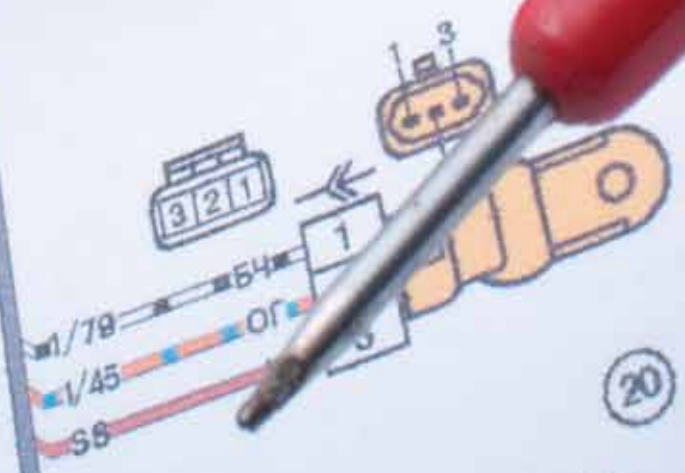
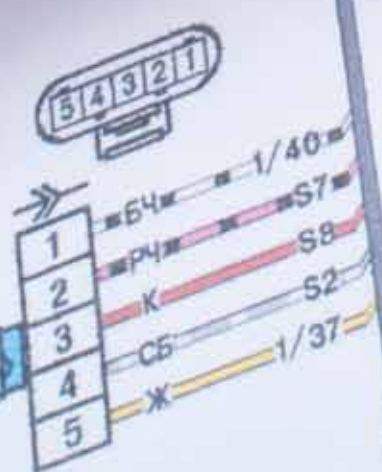
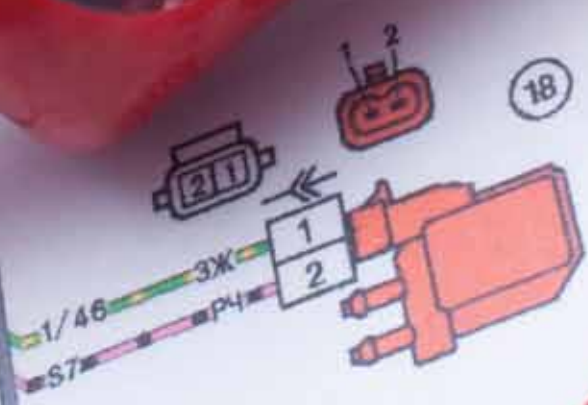
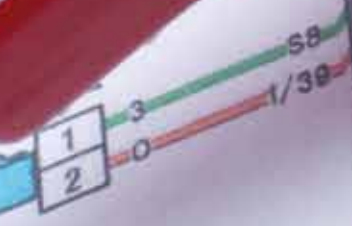

20

2/10